

## MIRA-W

~40° wide beam

### SPECIFICATION:

Dimensions	Ø 32.4
Height	14.7 mm
Fastening	glue
ROHS compliant	yes ⓘ

### MATERIALS:

Component	Type	Material	Colour	Finish	Length (mm)
MIRA-W	Single lens	PC	clear		



### ORDERING INFORMATION:

Component	Qty in box	MOQ	MPQ	Box weight (kg)
C12501_MIRA-W » Box size: 480 x 280 x 300 mm	840	120	60	7.2

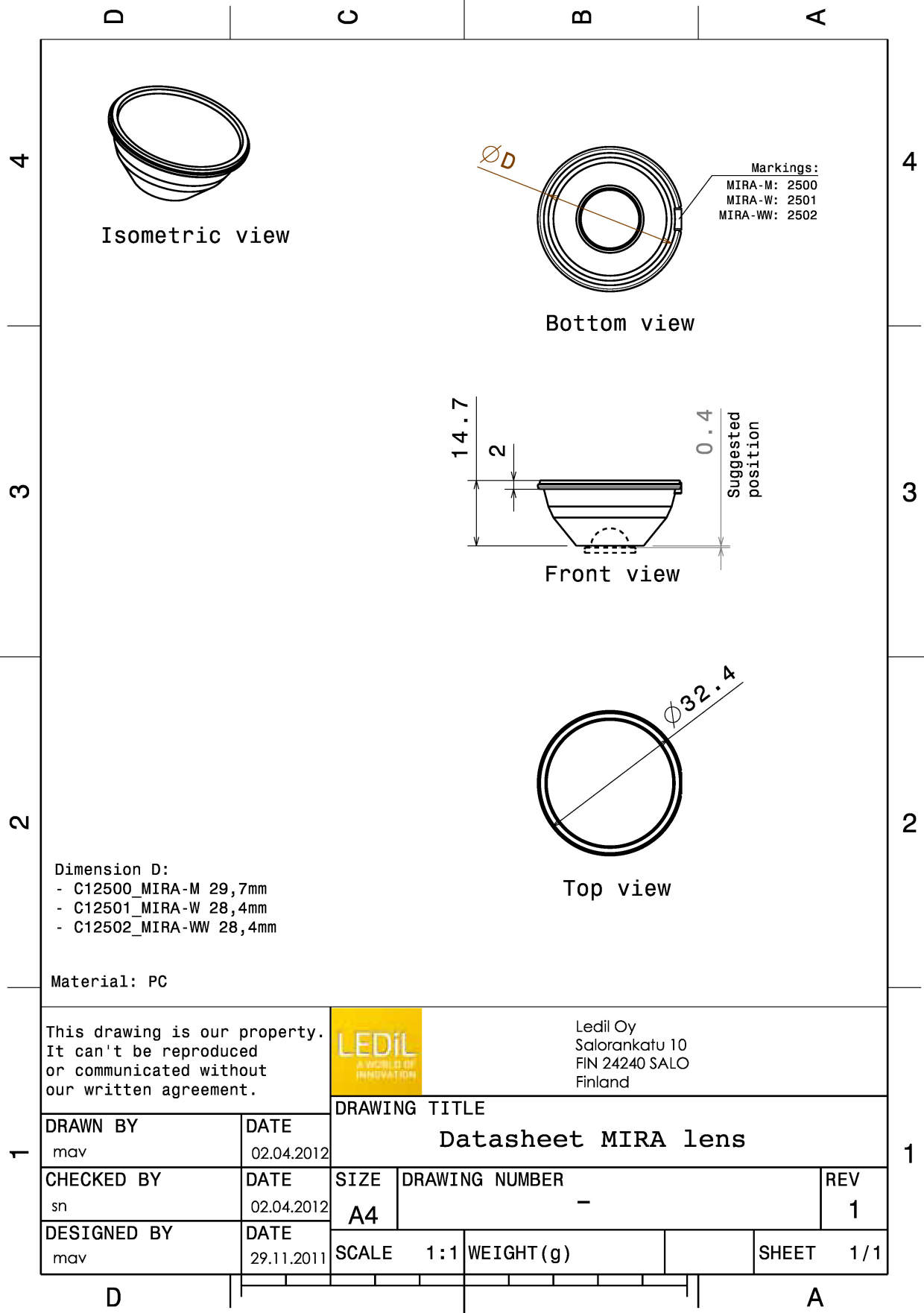

See also our general installation guide: [www.ledil.com/installation\\_guide](http://www.ledil.com/installation_guide)

### OPTICAL RESULTS (MEASURED):



LED BXRA ES Star  
FWHM / FWTM 39.0° / 76.0°  
Efficiency 82 %  
LEDs/each optic 1  
Light colour/type White  
Required components:



Light distribution files



LED V10 Gen6  
FWHM / FWTM 44.0° / 82.0°  
Efficiency 77 %  
Peak intensity 1.3 cd/lm  
LEDs/each optic 1  
Light colour/type White  
Required components:

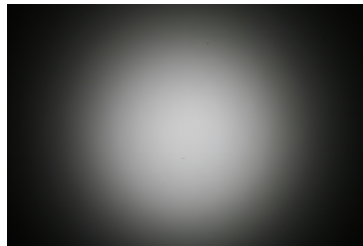

Light distribution files



LED CXA/B 15xx  
FWHM / FWTM 39.0° / 77.0°  
Efficiency 80 %  
Peak intensity 1.4 cd/lm  
LEDs/each optic 1  
Light colour/type White  
Required components:

### OPTICAL RESULTS (MEASURED):



LED MHD-E/G  
 FWHM / FWTM 43.0° / 83.0°  
 Efficiency 81 %  
 Peak intensity 1.1 cd/lm  
 LEDs/each optic 1  
 Light colour/type White  
 Required components:

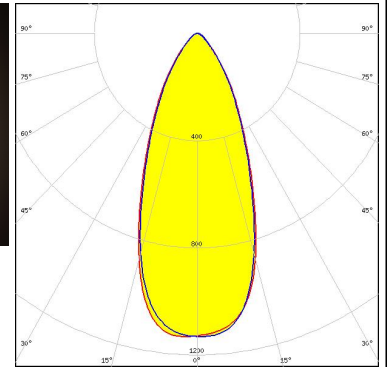
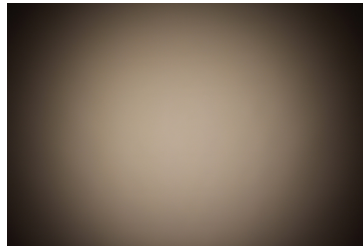

Light distribution files



LED MT-G  
 FWHM / FWTM 38.0° / 78.0°  
 Efficiency 80 %  
 Peak intensity 1.4 cd/lm  
 LEDs/each optic 1  
 Light colour/type White  
 Required components:

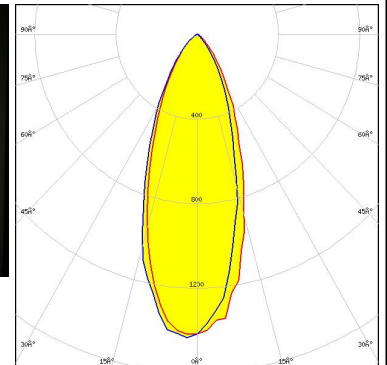
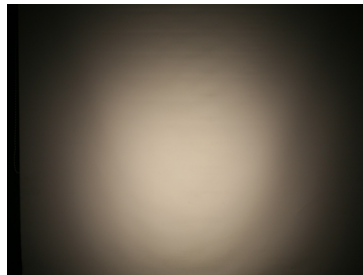

Light distribution files



LED XHP70  
 FWHM / FWTM 42.0° / 81.0°  
 Efficiency 80 %  
 Peak intensity 1.2 cd/lm  
 LEDs/each optic 1  
 Light colour/type White  
 Required components:

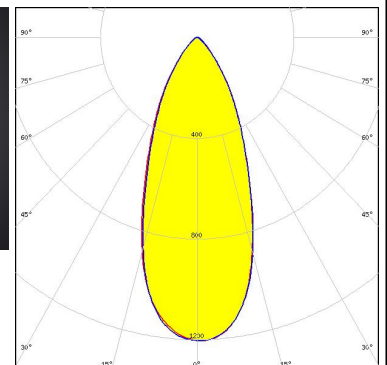
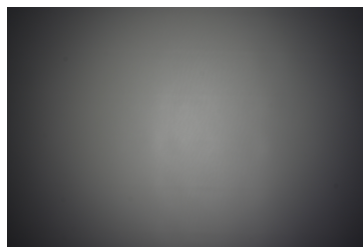

Light distribution files



### OPTICAL RESULTS (MEASURED):



LED LUXEON M/MX  
FWHM / FWTM 39.0° / 78.0°  
Efficiency 82 %  
LEDs/each optic 1  
Light colour/type White  
Required components:



Light distribution files



LED LUXEON MZ  
FWHM / FWTM 31.0° / 67.0°  
Efficiency 79 %  
Peak intensity 2 cd/lm  
LEDs/each optic 1  
Light colour/type White  
Required components:

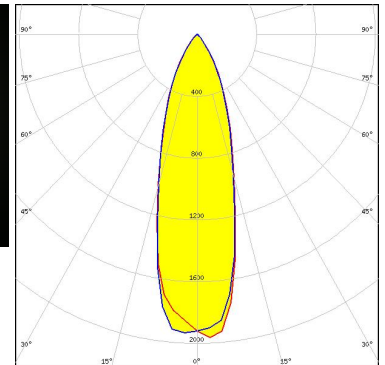
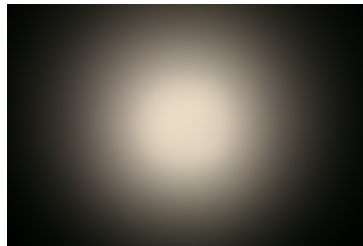

Light distribution files



LED NFMW48xA  
FWHM / FWTM 32.0° / 68.0°  
Efficiency 80 %  
Peak intensity 1.8 cd/lm  
LEDs/each optic 1  
Light colour/type White  
Required components:

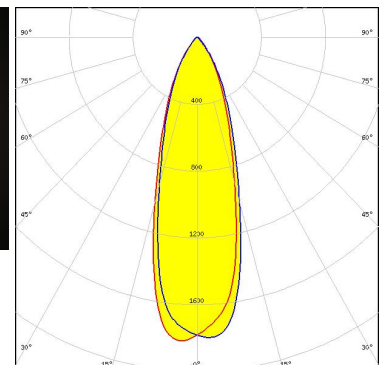
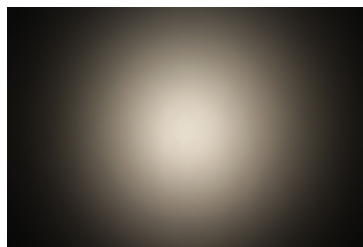

Light distribution files

### OPTICAL RESULTS (MEASURED):



**LED** NSCxL036A  
**FWHM / FWTM** 42.0° / 77.0°  
**Efficiency** 79 %  
**Peak intensity** 1.3 cd/lm  
**LEDs/each optic** 1  
**Light colour/type** White  
**Required components:**

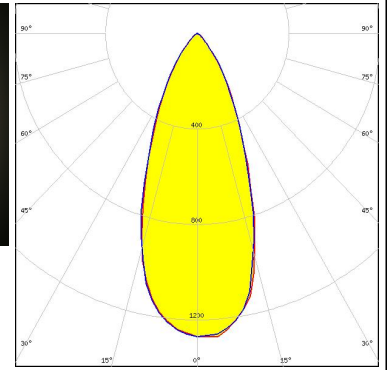

Light distribution files



**LED** NSMx286M  
**FWHM / FWTM** 28.0° / 63.0°  
**Efficiency** 77 %  
**Peak intensity** 2.1 cd/lm  
**LEDs/each optic** 1  
**Light colour/type** White  
**Required components:**

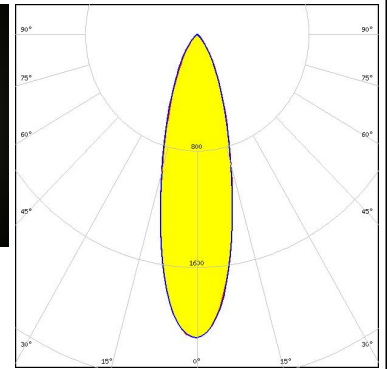
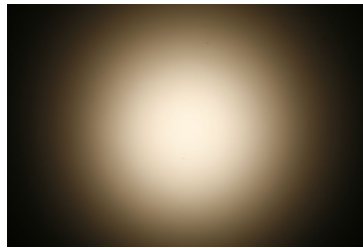

Light distribution files



**LED** Duris S10  
**FWHM / FWTM** 34.0° / 74.0°  
**Efficiency** 83 %  
**Peak intensity** 1.9 cd/lm  
**LEDs/each optic** 1  
**Light colour/type** White  
**Required components:**

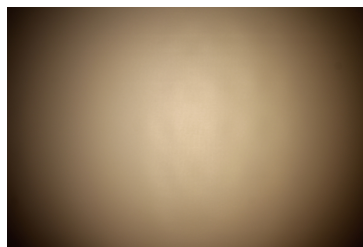

Light distribution files

### OPTICAL RESULTS (SIMULATED):



**LED** VERO10  
**FWHM / FWTM** 38.8° / 73.4°  
**Efficiency** 88 %  
**Peak intensity** 1.6 cd/lm  
**LEDs/each optic** 1  
**Light colour/type** White  
**Required components:**

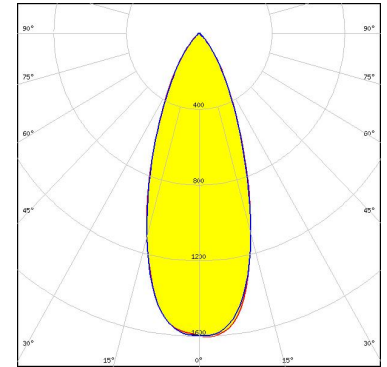

Light distribution files



**LED** LUXEON 5258  
**FWHM / FWTM** 31.0° / 65.0°  
**Efficiency** 92 %  
**Peak intensity** 2.3 cd/lm  
**LEDs/each optic** 1  
**Light colour/type** White  
**Required components:**

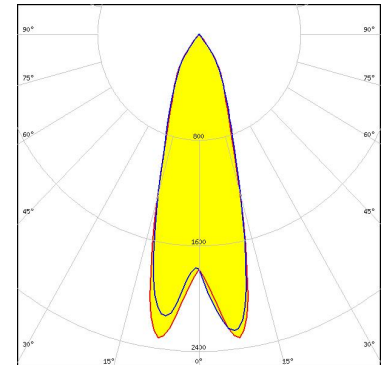

Light distribution files



**LED** LUXEON K4  
**FWHM / FWTM** 34.0° / 67.0°  
**Efficiency** 87 %  
**Peak intensity** 1.8 cd/lm  
**LEDs/each optic** 1  
**Light colour/type** White  
**Required components:**

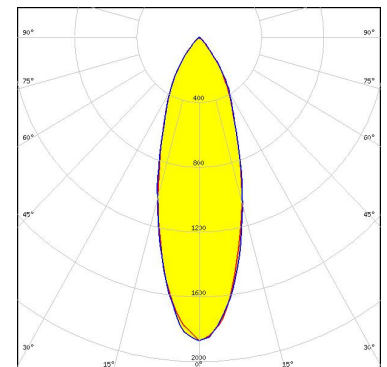

Light distribution files

### OPTICAL RESULTS (SIMULATED):

**OSRAM**  
Opto Semiconductors

LED OSCONIQ P 7070  
 FWHM / FWTM 51.0° / 90.0°  
 Efficiency 91 %  
 Peak intensity 1.1 cd/lm  
 LEDs/each optic 1  
 Light colour/type White  
 Required components:

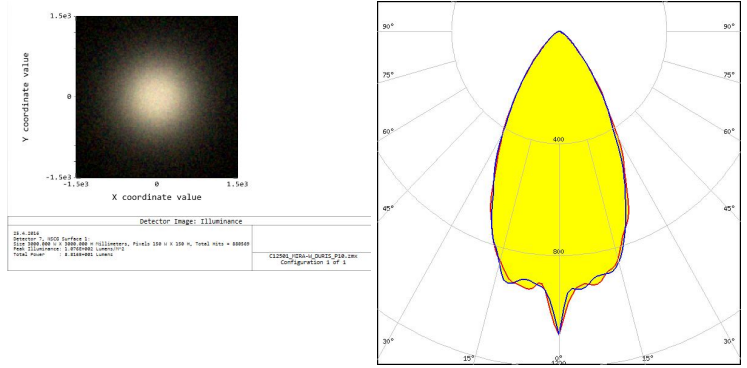

Light distribution files

### GENERAL INFORMATION:

NOTE: The typical beam angle will be changed by different color, chip size and chip position tolerance. The typical total beam angle is the full angle measured where the luminous intensity is half of the peak value.

Due to use of high power COB's with this product, special attention to proper thermal design is highly recommended. LEDiL has no liability for direct, indirect or consecutive damages arising from the LEDiL products being used outside of the recommended temperature range.

### MATERIALS:

As part of our continuous research and improvement processes, and to ensure the best possible quality and availability of our products, LEDiL reserves the right to change material grades without notice.

### PRODUCT DATA USER AGREEMENT AND DISCLAIMER:

The measured data in the provided downloadable LEDiL Product Datasheets and Mechanical 2D-Drawings is rounded and provided as reference for planning. LEDiL Oy's optical specifications have been verified by conducting performance testing of the products in accordance with the company's quality system. The reported data are averaged results of multiple measurements with typical variation. LEDiL Oy reserves the right to without prior notification make changes and improvements to its products.

LEDiL Oy assumes neither warranty, nor guarantee nor any other liability of any kind for the contents and correctness of the provided data. The provided data has been generated with highest diligence but the provided data may in reality not represent the complete possible variation range of all intrinsic parameters. Therefore, in certain cases a deviation from the provided data could occur.

LEDiL Oy reserves the right to undertake technical changes of its products without further notification which could lead to changes in the provided data. LEDiL Oy assumes no liability of any kind for the possible deviation from any provided data or any other damage resulting from the usage of the provided data.

The user agrees to this disclaimer and user agreement with the download or usage of the provided files.

#### LEDiL Oy

Joensuunkatu 7  
FI-24240 SALO  
Finland

#### LEDiL Inc.

228 West Page Street  
Suite D  
Sycamore IL 60178  
USA

#### Ledil Optics Technology (Shenzhen) Co., Ltd.

# 405 , Block B  
Casic Motor Building  
Shenzhen 518057  
P.R.CHINA

#### Local sales and technical support

[www.ledil.com/  
where\\_to\\_buy](http://www.ledil.com/where_to_buy)

#### Shipping locations

Poznan, Poland  
Hong Kong, China

#### Distribution Partners

[www.ledil.com/  
where\\_to\\_buy](http://www.ledil.com/where_to_buy)