

OLGA-SC2-RS2

~5° spot beam beam. Optimized for high-power 3535 size LED packages. Assembly with black SC2-holder.

SPECIFICATION:

Dimensions	Ø 32.0
Height	19 mm
Fastening	solder clip
ROHS compliant	yes ⓘ



MATERIALS:

Component	Type	Material	Colour	Finish	Length (mm)
OLGA-RS2	Single lens	PMMA	clear	gloss	

ORDERING INFORMATION:

Component	Qty in box	MOQ	MPQ	Box weight (kg)
LP20248_OLGA-SC2-RS2 » Box size: 476 x 273 x 292 mm	792	132	66	10.0

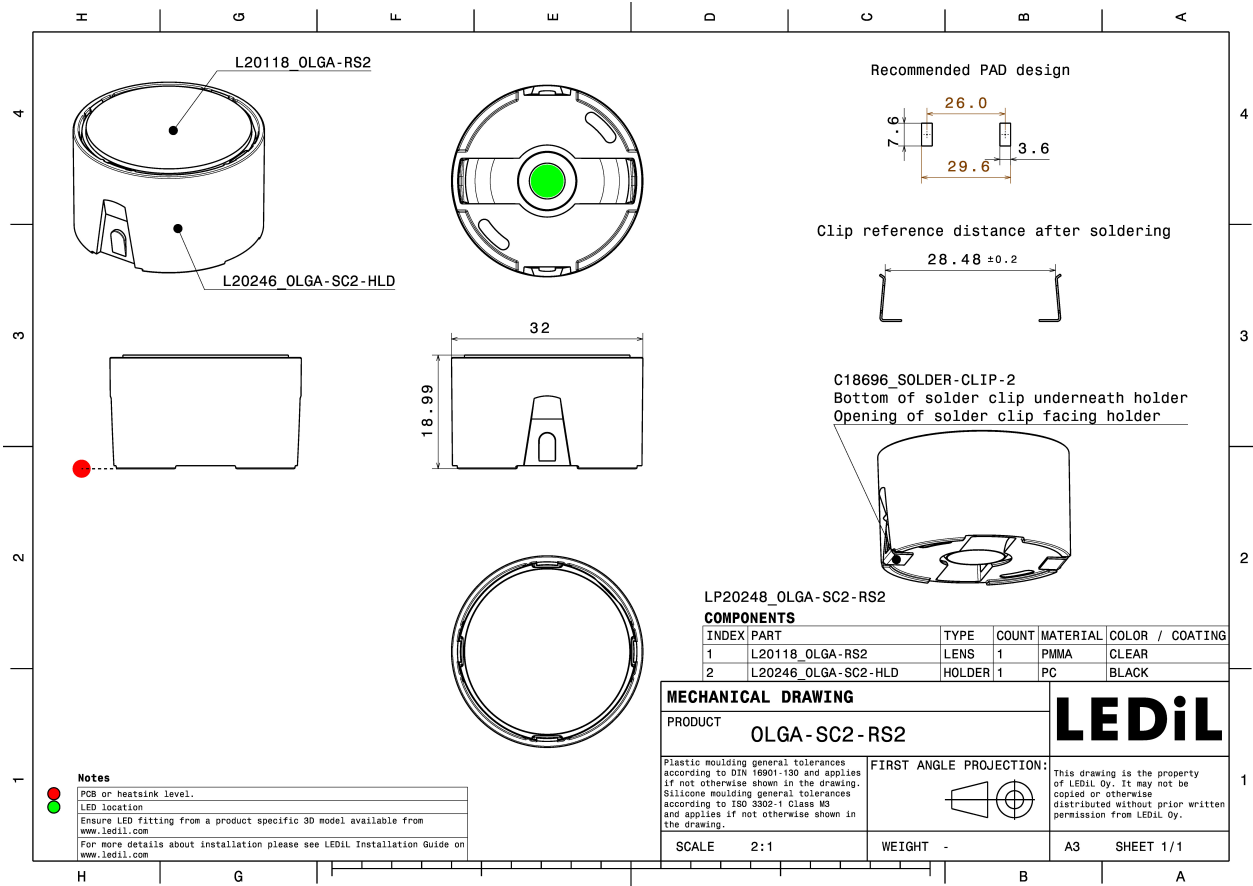

See also our general installation guide: www.ledil.com/installation_guide

OPTICAL RESULTS (MEASURED):



LED XQ-E HI
FWHM / FWTM 4.0° / 8.0°
Efficiency 95 %
Peak intensity 119.7 cd/lm
LEDs/each optic 1
Light colour/type White
Required components:

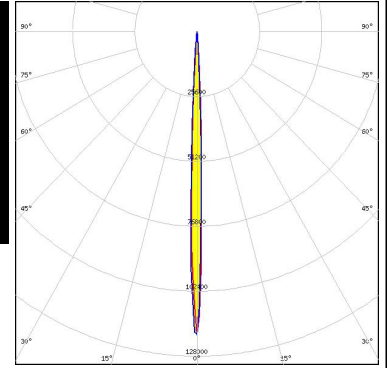

Light distribution files

OPTICAL RESULTS (SIMULATED):



LED XHP35.2 HD
 FWHM / FWTM 16.0° / 26.0°
 Efficiency 90 %
 Peak intensity 10.8 cd/lm
 LEDs/each optic 1
 Light colour/type White
 Required components:

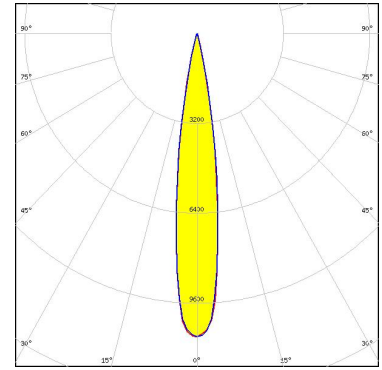

Light distribution files



LED XHP35.2 HI
 FWHM / FWTM 12.0° / 22.0°
 Efficiency 93 %
 Peak intensity 17.3 cd/lm
 LEDs/each optic 1
 Light colour/type White
 Required components:

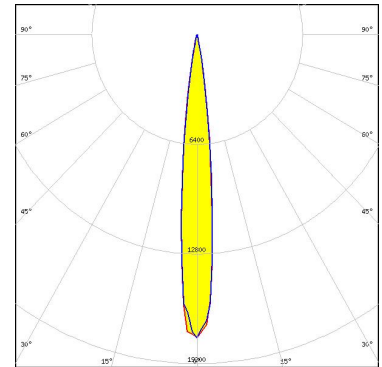

Light distribution files



LED XHP50.3 HD
 FWHM / FWTM 17.0° / 28.0°
 Efficiency 90 %
 Peak intensity 9.2 cd/lm
 LEDs/each optic 1
 Light colour/type White
 Required components:

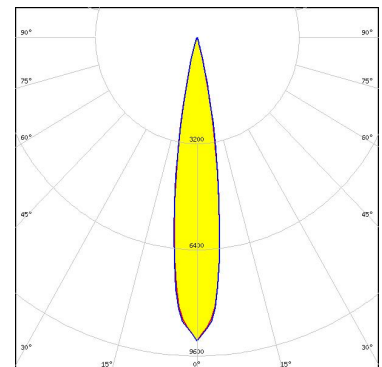

Light distribution files

OPTICAL RESULTS (SIMULATED):



LED XHP50.3 HI
 FWHM / FWTM 13.0° / 23.0°
 Efficiency 93 %
 Peak intensity 14 cd/lm
 LEDs/each optic 1
 Light colour/type White
 Required components:

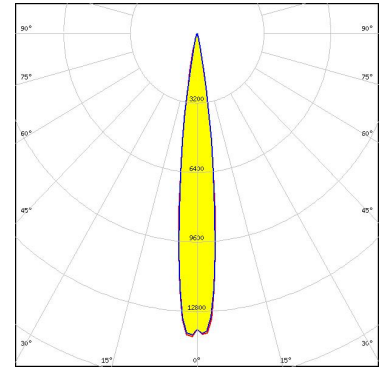

Light distribution files



LED XP-E2
 FWHM / FWTM 5.0° / 10.0°
 Efficiency 95 %
 Peak intensity 86.4 cd/lm
 LEDs/each optic 1
 Light colour/type White
 Required components:

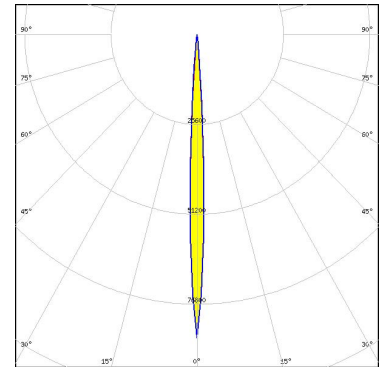

Light distribution files



LED XP-G4
 FWHM / FWTM 9.0° / 15.0°
 Efficiency 94 %
 Peak intensity 35.8 cd/lm
 LEDs/each optic 1
 Light colour/type White
 Required components:

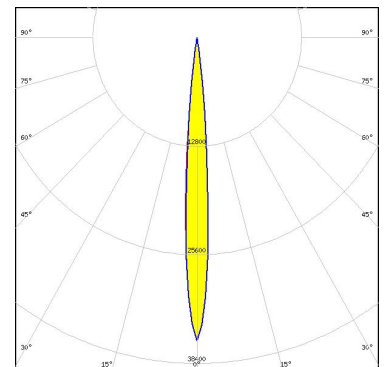

Light distribution files

OPTICAL RESULTS (SIMULATED):



LED XP-L HI
 FWHM / FWTM 8.0° / 14.0°
 Efficiency 94 %
 Peak intensity 40.4 cd/lm
 LEDs/each optic 1
 Light colour/type White
 Required components:

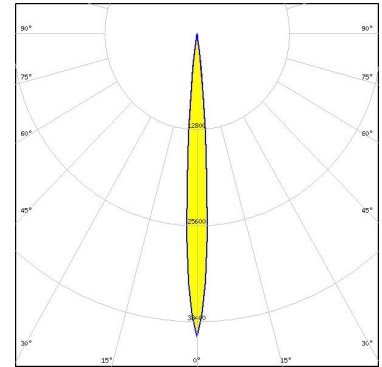

Light distribution files



LED XP-L2
 FWHM / FWTM 13.0° / 22.0°
 Efficiency 91 %
 Peak intensity 16 cd/lm
 LEDs/each optic 1
 Light colour/type White
 Required components:

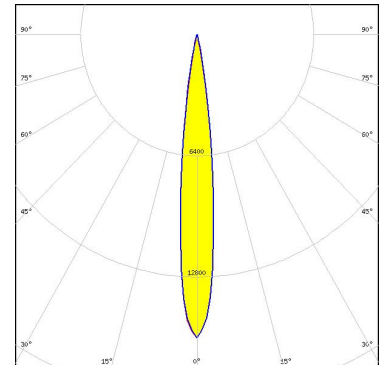

Light distribution files



LED XP-P
 FWHM / FWTM 4.0° / 8.0°
 Efficiency 95 %
 Peak intensity 123.6 cd/lm
 LEDs/each optic 1
 Light colour/type White
 Required components:

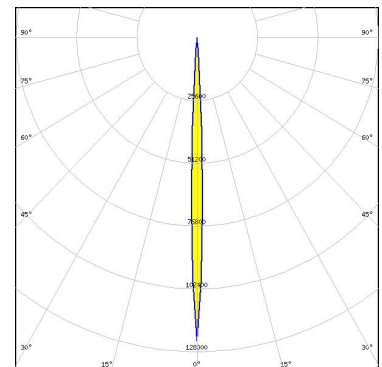

Light distribution files

OPTICAL RESULTS (SIMULATED):



LED LUXEON CZ
FWHM / FWTM 4.0° / 8.0°
Efficiency 95 %
Peak intensity 135.6 cd/lm
LEDs/each optic 1
Light colour/type White
Required components:

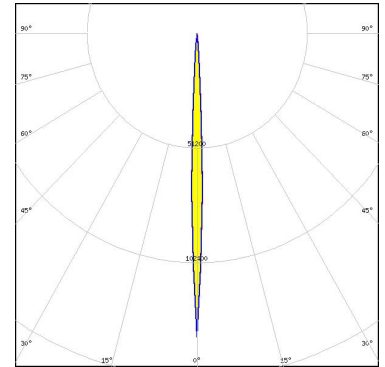

Light distribution files



LED LUXEON Rubix
FWHM / FWTM 4.0° / 8.0°
Efficiency 95 %
Peak intensity 118.3 cd/lm
LEDs/each optic 1
Light colour/type White
Required components:

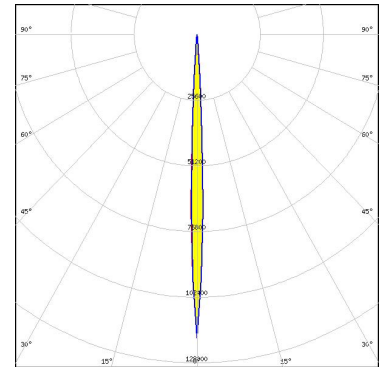

Light distribution files



LED LUXEON TX
FWHM / FWTM 8.0° / 14.0°
Efficiency 94 %
Peak intensity 41 cd/lm
LEDs/each optic 1
Light colour/type White
Required components:

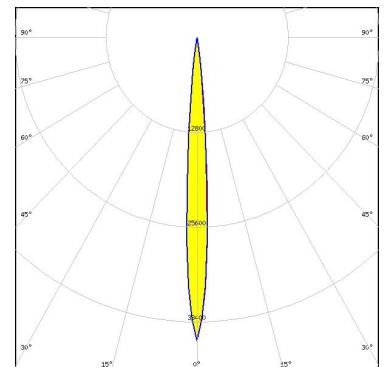

Light distribution files

OPTICAL RESULTS (SIMULATED):



LED SFT-10-CG
FWHM / FWTM 4.0° / 8.0°
Efficiency 92 %
Peak intensity 140 cd/lm
LEDs/each optic 1
Light colour/type PC Green
Required components:

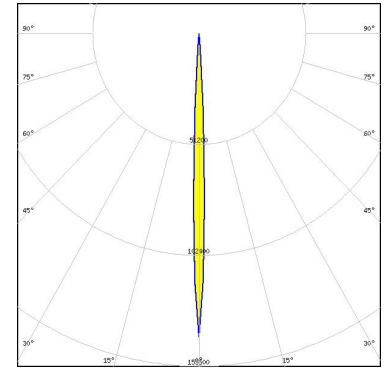

Light distribution files



LED SFT-20-CG
FWHM / FWTM 6.0° / 11.0°
Efficiency 93 %
Peak intensity 77.8 cd/lm
LEDs/each optic 1
Light colour/type PC Green
Required components:

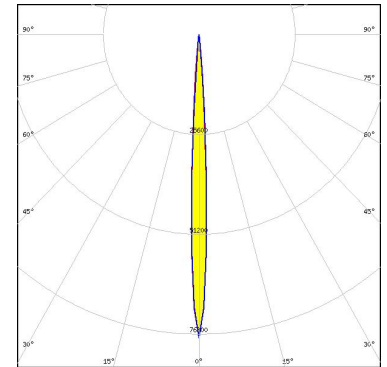

Light distribution files



LED NVSW219C-V2
FWHM / FWTM 8.0° / 14.0°
Efficiency 94 %
Peak intensity 50.8 cd/lm
LEDs/each optic 1
Light colour/type White
Required components:

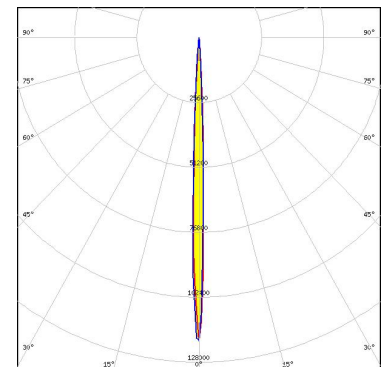

Light distribution files

OPTICAL RESULTS (SIMULATED):

OSRAM
Opto Semiconductors

LED OSCONIQ C 2424 Gen1
 FWHM / FWTM 6.0° / 12.0°
 Efficiency 95 %
 Peak intensity 57 cd/lm
 LEDs/each optic 1
 Light colour/type White
 Required components:

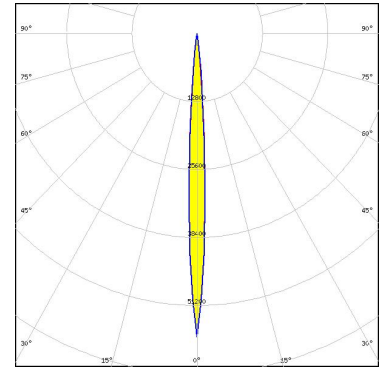

Light distribution files

OSRAM
Opto Semiconductors

LED OSLOM Square CSSRM2/CSSRM3
 FWHM / FWTM 8.0° / 15.0°
 Efficiency 93 %
 Peak intensity 36.3 cd/lm
 LEDs/each optic 1
 Light colour/type White
 Required components:

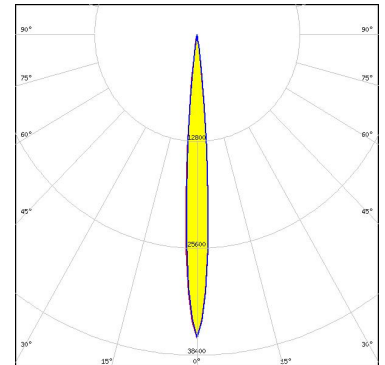

Light distribution files

OSRAM
Opto Semiconductors

LED OSLOM SSL 150
 FWHM / FWTM 5.0° / 10.0°
 Efficiency 95 %
 Peak intensity 84.7 cd/lm
 LEDs/each optic 1
 Light colour/type White
 Required components:

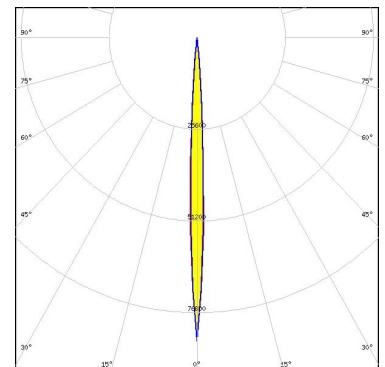

Light distribution files

GENERAL INFORMATION:

NOTE: The typical beam angle will be changed by different color, chip size and chip position tolerance. The typical total beam angle is the full angle measured where the luminous intensity is half of the peak value.

MATERIALS:

As part of our continuous research and improvement processes, and to ensure the best possible quality and availability of our products, LEDiL reserves the right to change material grades without notice.

PRODUCT DATA USER AGREEMENT AND DISCLAIMER:

The measured data in the provided downloadable LEDiL Product Datasheets and Mechanical 2D-Drawings is rounded and provided as reference for planning. LEDiL Oy's optical specifications have been verified by conducting performance testing of the products in accordance with the company's quality system. The reported data are averaged results of multiple measurements with typical variation. LEDiL Oy reserves the right to without prior notification make changes and improvements to its products.

LEDiL Oy assumes neither warranty, nor guarantee nor any other liability of any kind for the contents and correctness of the provided data. The provided data has been generated with highest diligence but the provided data may in reality not represent the complete possible variation range of all intrinsic parameters. Therefore, in certain cases a deviation from the provided data could occur.

LEDiL Oy reserves the right to undertake technical changes of its products without further notification which could lead to changes in the provided data. LEDiL Oy assumes no liability of any kind for the possible deviation from any provided data or any other damage resulting from the usage of the provided data.

The user agrees to this disclaimer and user agreement with the download or usage of the provided files.

LEDiL Oy

Joensuunkatu 7
FI-24100 SALO
Finland

LEDiL Inc.

228 West Page Street
Suite D
Sycamore IL 60178
USA

Ledil Optics Technology (Shenzhen) Co., Ltd.

405 , Block B
Casic Motor Building
Shenzhen 518057
P.R.CHINA

Local sales and technical support

[www.ledil.com/
where_to_buy](http://www.ledil.com/where_to_buy)

Shipping locations

Poznan, Poland
Hong Kong, China

Distribution Partners

[www.ledil.com/
where_to_buy](http://www.ledil.com/where_to_buy)