

## ROSE-MRK-W

~60° wide beam. Assembly with white holder.

### SPECIFICATION:

Dimensions	21.6 x 21.6 mm
Height	13 mm
Fastening	tape, pin
ROHS compliant	yes ⓘ

### MATERIALS:

Component	Type	Material	Colour	Finish	Length
ROSE-MRK-W	Single lens	PC	clear		21.6
ROSE-MRK-LT-HLD	Holder	PC	white		21.6
ROSE-TAPE	Tape	Acrylic foam	black		21.6



### ORDERING INFORMATION:

Component	Qty in box	MOQ	MPQ	Box weight (kg)
FA15233_ROSE-MRK-W » Box size: 457 x 260 x 260 mm	2304	288	144	11.0

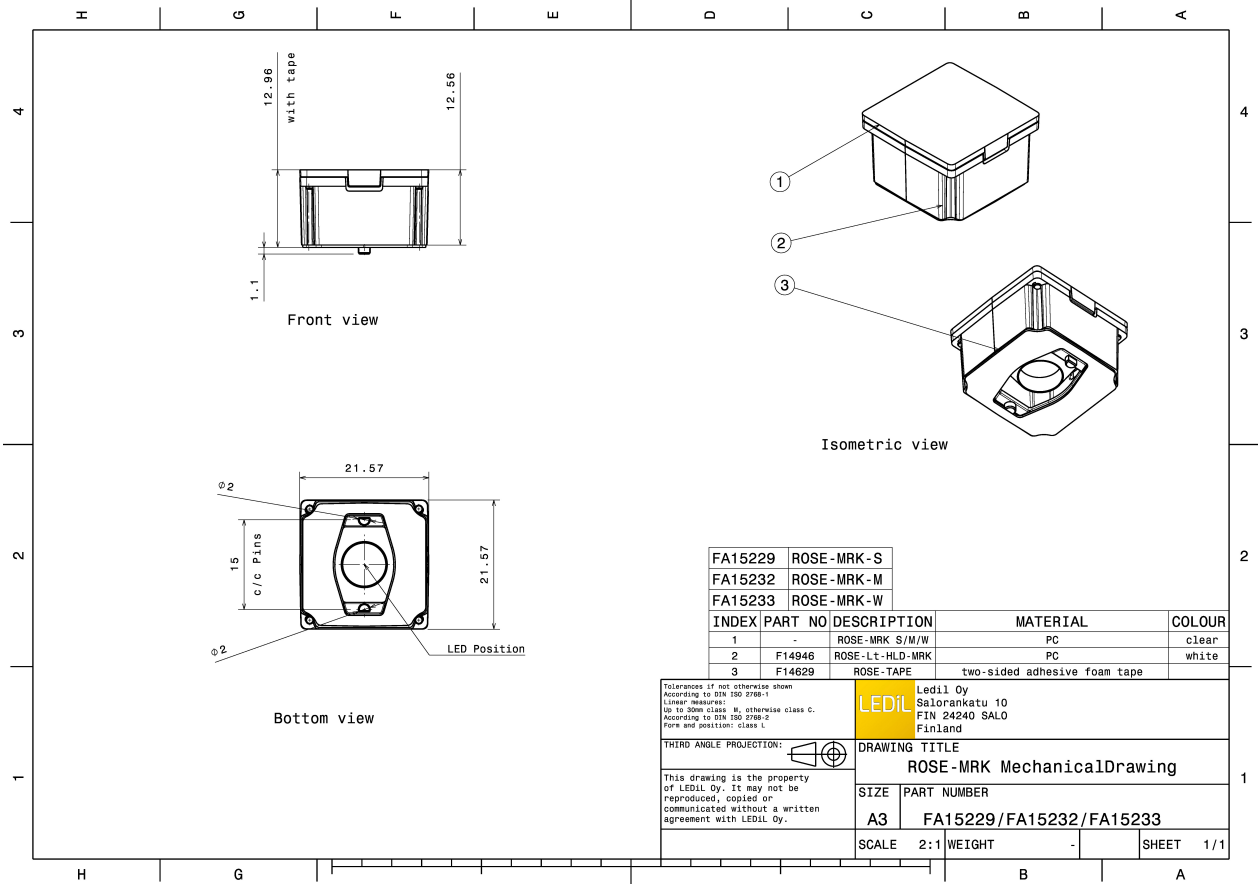

See also our general installation guide: [www.ledil.com/installation\\_guide](http://www.ledil.com/installation_guide)

### OPTICAL RESULTS (MEASURED):

#### LUMILEDS

LED LUXEON 5050 Round LES  
FWHM / FWTM 51.0° / 98.0°  
Efficiency 85 %  
Peak intensity 0.9 cd/lm  
LEDs/each optic 1  
Light colour/type White  
Required components:

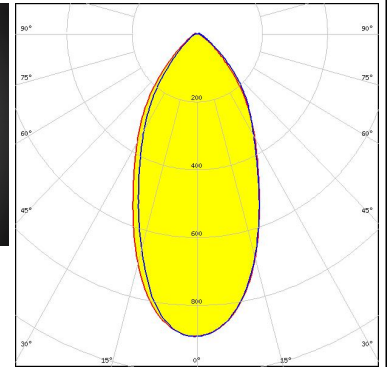
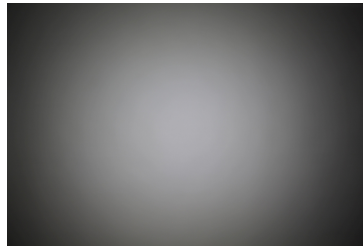

Light distribution files

#### LUMILEDS

LED LUXEON M/MX  
FWHM / FWTM 62.0° / 107.0°  
Efficiency 84 %  
Peak intensity 0.7 cd/lm  
LEDs/each optic 1  
Light colour/type White  
Required components:

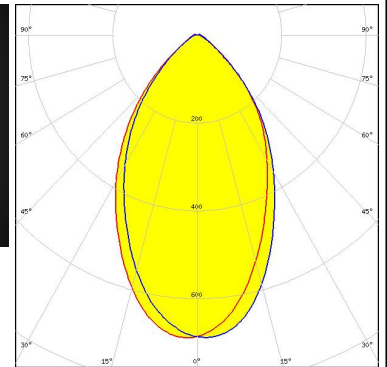
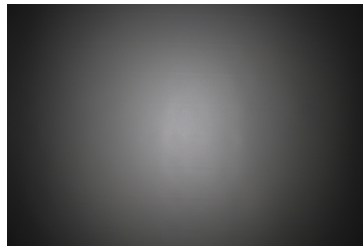

Light distribution files

### OPTICAL RESULTS (SIMULATED):



LED XHP70  
FWHM / FWTM 77.0° / 106.0°  
Efficiency 92 %  
Peak intensity 0.6 cd/lm  
LEDs/each optic 1  
Light colour/type White  
Required components:

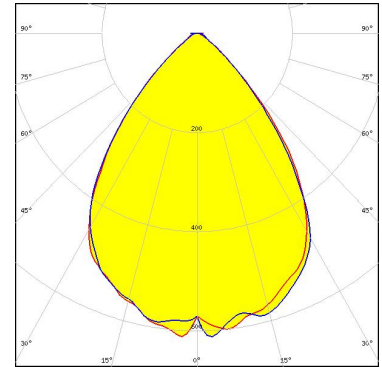

Light distribution files



LED XM-L  
FWHM / FWTM 72.5° / 111.5°  
Efficiency 87 %  
Peak intensity 0.6 cd/lm  
LEDs/each optic 1  
Light colour/type White  
Required components:

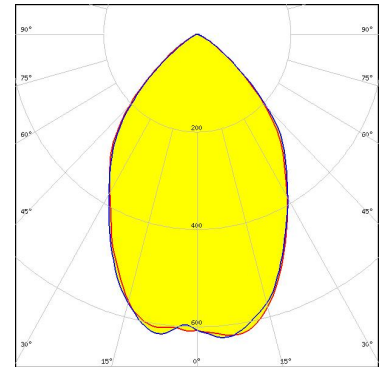

Light distribution files



LED XM-L2  
FWHM / FWTM 75.5° / 112.0°  
Efficiency 87 %  
Peak intensity 0.6 cd/lm  
LEDs/each optic 1  
Light colour/type White  
Required components:

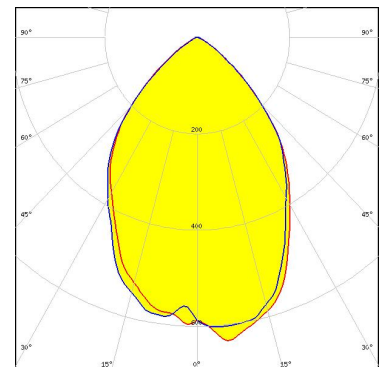

Light distribution files

### OPTICAL RESULTS (SIMULATED):



LED XP-G3  
FWHM / FWTM 68.0° / 110.0°  
Efficiency 85 %  
Peak intensity 0.6 cd/lm  
LEDs/each optic 1  
Light colour/type White  
Required components:

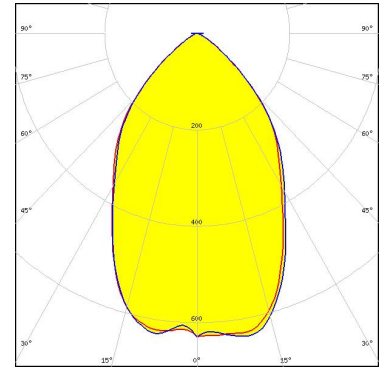

Light distribution files



LED XP-L2  
FWHM / FWTM 62.0° / 110.0°  
Efficiency 85 %  
Peak intensity 0.7 cd/lm  
LEDs/each optic 1  
Light colour/type White  
Required components:

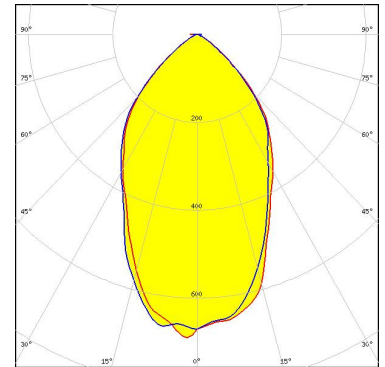

Light distribution files



LED LUXEON 7070  
FWHM / FWTM 62.0° / 104.0°  
Efficiency 86 %  
Peak intensity 0.8 cd/lm  
LEDs/each optic 1  
Light colour/type White  
Required components:

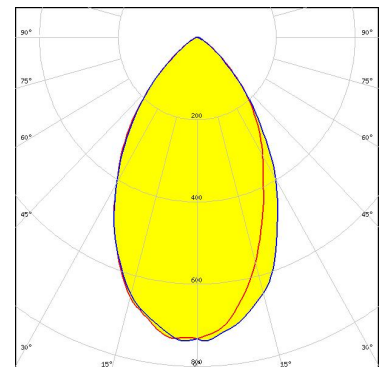

Light distribution files

### OPTICAL RESULTS (SIMULATED):



LED SST-20  
FWHM / FWTM 49.0° / 102.0°  
Efficiency 87 %  
Peak intensity 1 cd/lm  
LEDs/each optic 1  
Light colour/type White  
Required components:

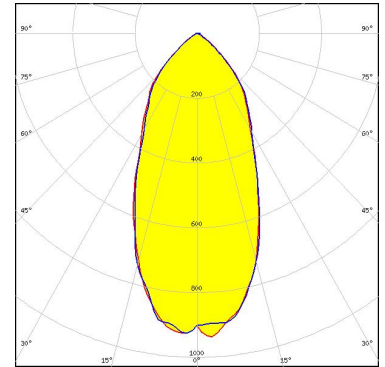

Light distribution files



LED NFMW48xA  
FWHM / FWTM 62.0° / 106.0°  
Efficiency 87 %  
Peak intensity 0.8 cd/lm  
LEDs/each optic 1  
Light colour/type White  
Required components:

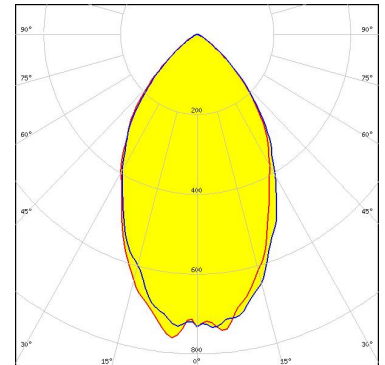

Light distribution files



LED NV4x144A  
FWHM / FWTM 78.0° / 114.0°  
Efficiency 84 %  
Peak intensity 0.6 cd/lm  
LEDs/each optic 1  
Light colour/type White  
Required components:

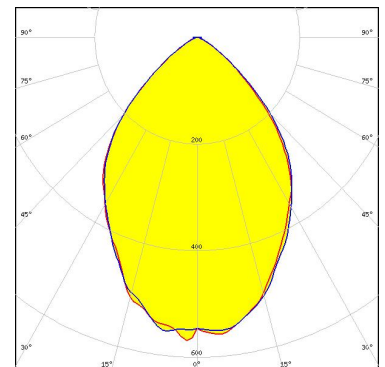

Light distribution files

#### OPTICAL RESULTS (SIMULATED):

**OSRAM**  
Opto Semiconductors

LED OSCONIQ P 7070  
FWHM / FWTM 56.0° / 102.0°  
Efficiency 87 %  
Peak intensity 0.9 cd/lm  
LEDs/each optic 1  
Light colour/type White  
Required components:

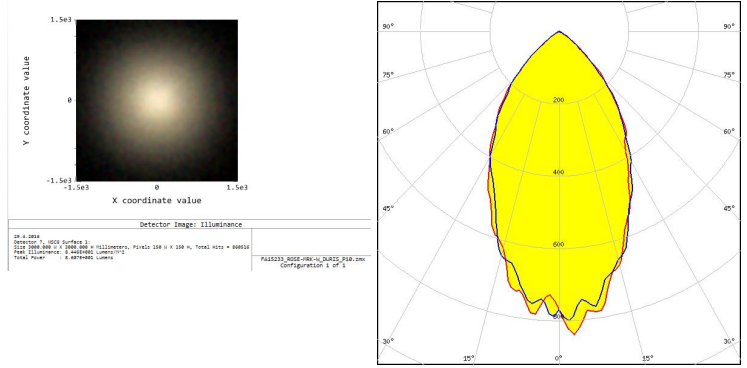

Light distribution files

#### GENERAL INFORMATION:

NOTE: The typical beam angle will be changed by different color, chip size and chip position tolerance. The typical total beam angle is the full angle measured where the luminous intensity is half of the peak value.

#### MATERIALS:

As part of our continuous research and improvement processes, and to ensure the best possible quality and availability of our products, LEDiL reserves the right to change material grades without notice.

#### PRODUCT DATA USER AGREEMENT AND DISCLAIMER:

The measured data in the provided downloadable LEDiL Product Datasheets and Mechanical 2D-Drawings is rounded and provided as reference for planning. LEDiL Oy's optical specifications have been verified by conducting performance testing of the products in accordance with the company's quality system. The reported data are averaged results of multiple measurements with typical variation. LEDiL Oy reserves the right to without prior notification make changes and improvements to its products.

LEDiL Oy assumes neither warranty, nor guarantee nor any other liability of any kind for the contents and correctness of the provided data. The provided data has been generated with highest diligence but the provided data may in reality not represent the complete possible variation range of all intrinsic parameters. Therefore, in certain cases a deviation from the provided data could occur.

LEDiL Oy reserves the right to undertake technical changes of its products without further notification which could lead to changes in the provided data. LEDiL Oy assumes no liability of any kind for the possible deviation from any provided data or any other damage resulting from the usage of the provided data.

The user agrees to this disclaimer and user agreement with the download or usage of the provided files.

#### LEDiL Oy

Joensuunkatu 13  
FI-24240 SALO  
Finland

#### LEDiL Inc.

228 West Page Street  
Suite D  
Sycamore IL 60178  
USA

#### Ledil Optics Technology (Shenzhen) Co., Ltd.

# 405 , Block B  
Casic Motor Building  
Shenzhen 518057  
P.R.CHINA

#### Local sales and technical support

[www.ledil.com/  
where\\_to\\_buy](http://www.ledil.com/where_to_buy)

#### Shipping locations

Poznan, Poland  
Hong Kong, China

#### Distribution Partners

[www.ledil.com/  
where\\_to\\_buy](http://www.ledil.com/where_to_buy)