

## STRADA-FT

Forward throw beam for area lighting optimized for XP-G and XP-E

### SPECIFICATION:

Dimensions	19.6 x 15.5 mm
Height	8.2 mm
Fastening	glue, pin, screw
ROHS compliant	yes ⓘ

### MATERIALS:

Component	Type	Material	Colour	Finish	Length
STRADA-FT	Single lens	PMMA	clear		19.6

### ORDERING INFORMATION:

Component	Qty in box	MOQ	MPQ	Box weight (kg)
C12049_STRADA-FT » Box size: 480 x 280 x 300 mm	2880	288	144	5.6

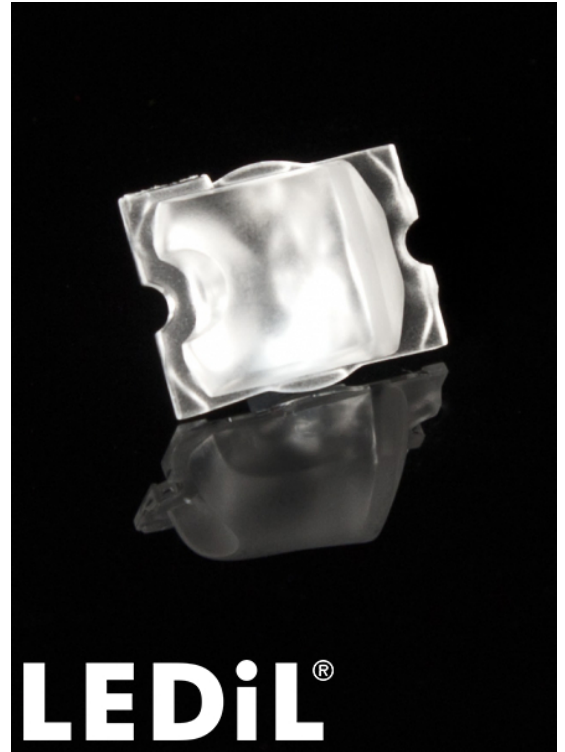

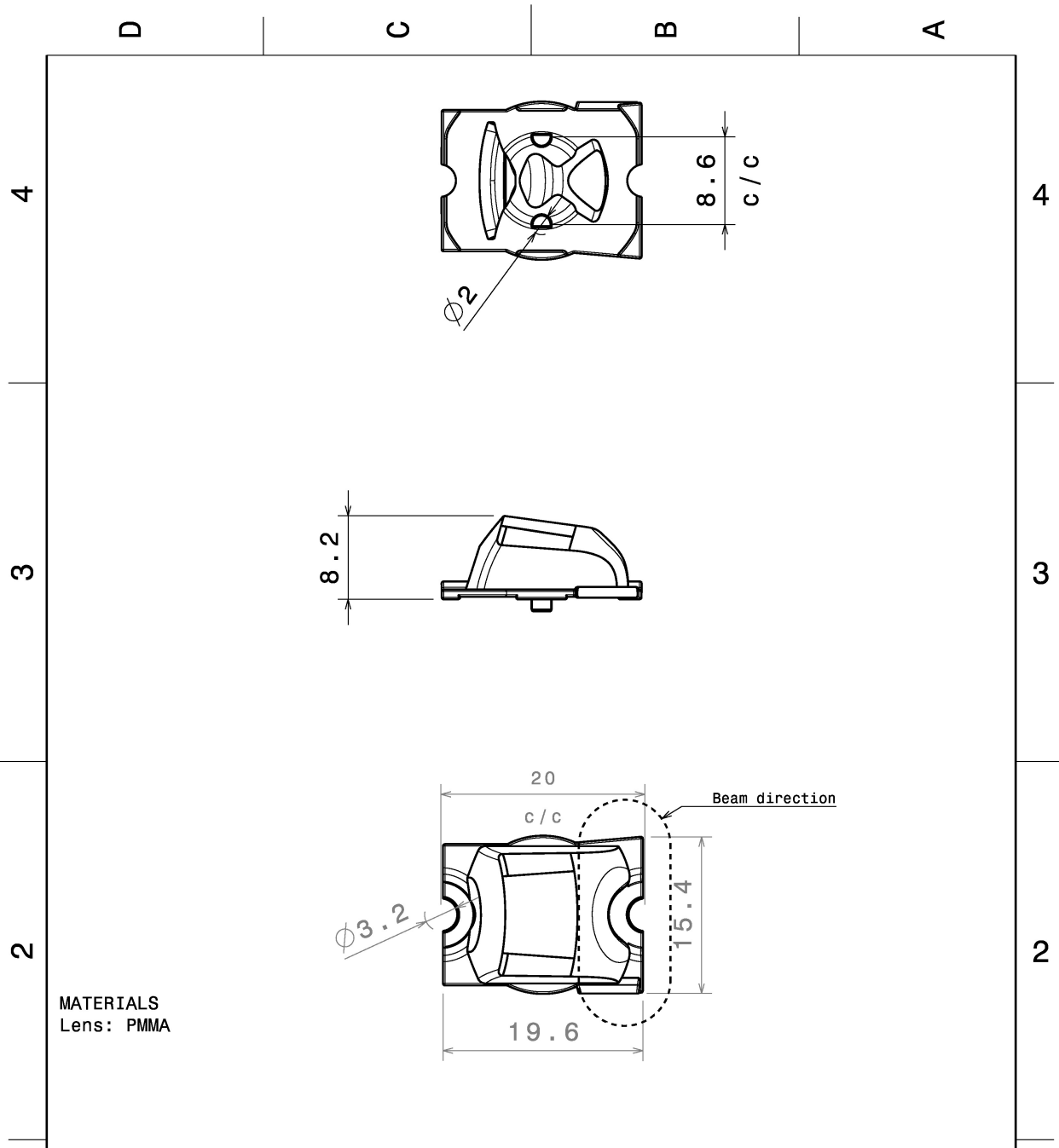

MATERIALS  
Lens: PMMA

This drawing is our property.  
It can't be reproduced  
or communicated without  
our written agreement.



Ledil Oy  
Salorankatu 10  
24240 SALO  
Finland

DRAWN BY ah		DATE 6.7.2012	DRAWING TITLE Datasheet Strada-FT lens			
CHECKED BY ah	DATE 6.7.2012	SIZE A4	DRAWING NUMBER			REV 2
DESIGNED BY hh	DATE 15.3.2011	SCALE 2:1	WEIGHT (g)	SHEET 1/1		

See also our general installation guide: [www.ledil.com/installation\\_guide](http://www.ledil.com/installation_guide)

### OPTICAL RESULTS (MEASURED):



LED XB-D  
FWHM / FWTM Asymmetric  
Efficiency 87 %  
LEDs/each optic 1  
Light colour/type White  
Required components:

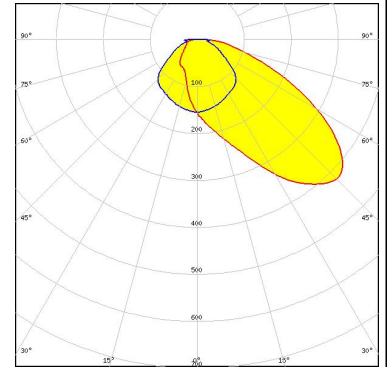

Light distribution files



LED XP-E  
FWHM / FWTM Asymmetric  
Efficiency 92 %  
LEDs/each optic 1  
Light colour/type White  
Required components:

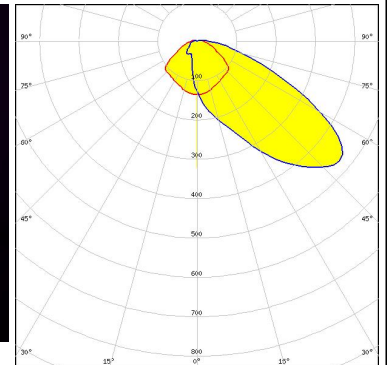
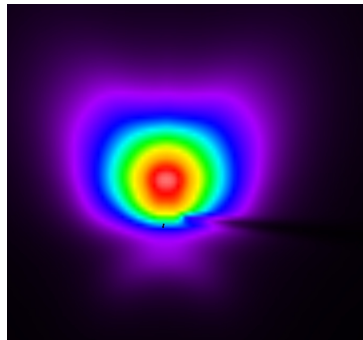

Light distribution files



LED XP-G  
FWHM / FWTM Asymmetric  
Efficiency 88 %  
LEDs/each optic 1  
Light colour/type White  
Required components:

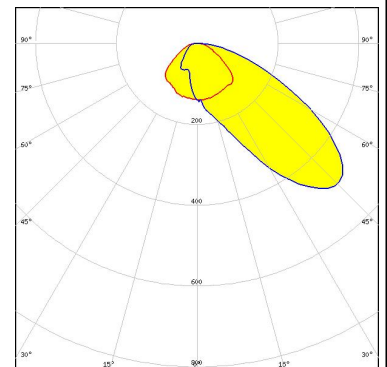

Light distribution files

### OPTICAL RESULTS (MEASURED):



LED LUXEON A  
FWHM / FWTM Asymmetric  
Efficiency 87 %  
LEDs/each optic 1  
Light colour/type White  
Required components:

Light distribution files



LED LUXEON Rebel  
FWHM / FWTM Asymmetric  
Efficiency 92 %  
LEDs/each optic 1  
Light colour/type White  
Required components:

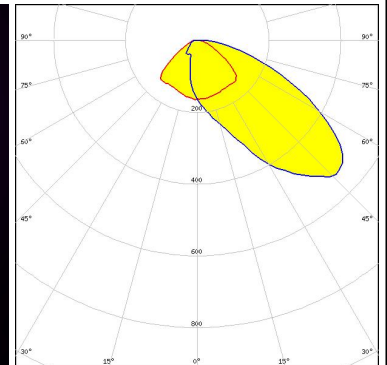
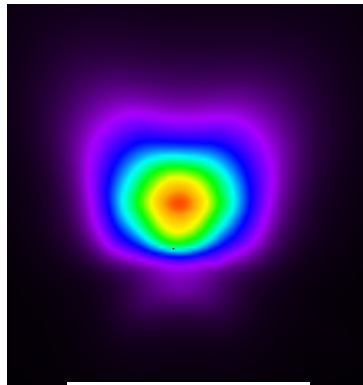

Light distribution files



LED LUXEON Rebel ES  
FWHM / FWTM Asymmetric  
Efficiency 92 %  
LEDs/each optic 1  
Light colour/type White  
Required components:

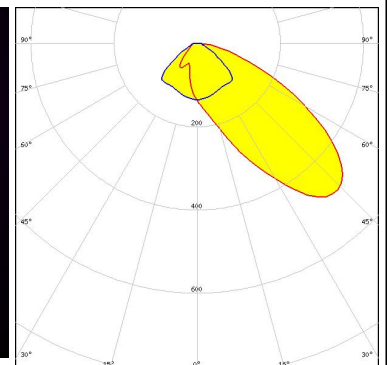
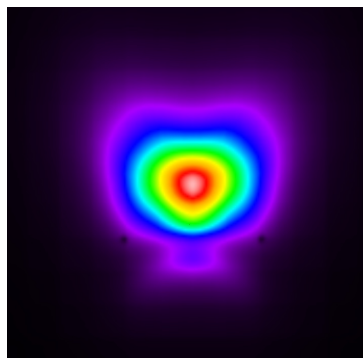

Light distribution files

### OPTICAL RESULTS (MEASURED):



LED NCSxx19A  
FWHM / FWTM Asymmetric  
Efficiency 92 %  
LEDs/each optic 1  
Light colour/type White  
Required components:

[Light distribution files](#)



LED NVSxx19A  
FWHM / FWTM Asymmetric  
Efficiency 92 %  
LEDs/each optic 1  
Light colour/type White  
Required components:

[Light distribution files](#)



LED OSLOM SSL 150  
FWHM / FWTM Asymmetric  
Efficiency 92 %  
LEDs/each optic 1  
Light colour/type White  
Required components:

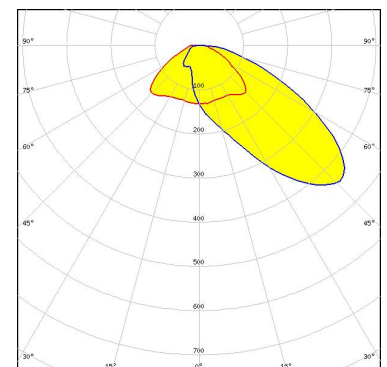

[Light distribution files](#)

### OPTICAL RESULTS (MEASURED):

**OSRAM**  
Opto Semiconductors

LED OSLON SSL 80  
FWHM / FWTM Asymmetric  
Efficiency 92 %  
LEDs/each optic 1  
Light colour/type White  
Required components:

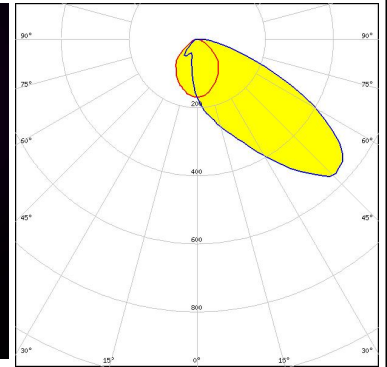
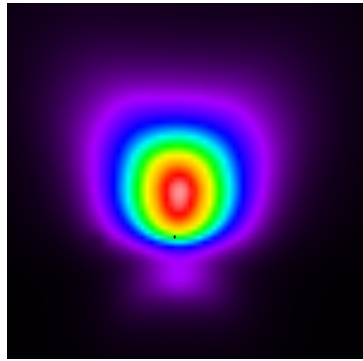

Light distribution files

**SEOL**  
SEOUL SEMICONDUCTOR

LED Z5  
FWHM / FWTM Asymmetric  
Efficiency 92 %  
LEDs/each optic 1  
Light colour/type White  
Required components:

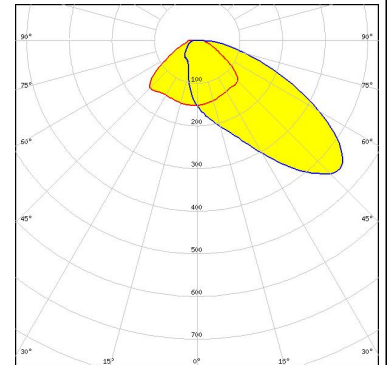

Light distribution files

**SHARP**

LED Double Dome (GM2BB)  
FWHM / FWTM Asymmetric  
Efficiency 92 %  
LEDs/each optic 1  
Light colour/type White  
Required components:

Light distribution files

### OPTICAL RESULTS (SIMULATED):

	
LED	LUXEON 3030 2D (Square LES)
FWHM / FWTM	Asymmetric
Efficiency	95 %
Peak intensity	0.8 cd/lm
LEDs/each optic	1
Light colour/type	White
Required components:	

Light distribution files

### GENERAL INFORMATION:

NOTE: The typical beam angle will be changed by different color, chip size and chip position tolerance. The typical total beam angle is the full angle measured where the luminous intensity is half of the peak value.

### MATERIALS:

As part of our continuous research and improvement processes, and to ensure the best possible quality and availability of our products, LEDiL reserves the right to change material grades without notice.

### PRODUCT DATA USER AGREEMENT AND DISCLAIMER:

The measured data in the provided downloadable LEDiL Product Datasheets and Mechanical 2D-Drawings is rounded and provided as reference for planning. LEDiL Oy's optical specifications have been verified by conducting performance testing of the products in accordance with the company's quality system. The reported data are averaged results of multiple measurements with typical variation. LEDiL Oy reserves the right to without prior notification make changes and improvements to its products.

LEDiL Oy assumes neither warranty, nor guarantee nor any other liability of any kind for the contents and correctness of the provided data. The provided data has been generated with highest diligence but the provided data may in reality not represent the complete possible variation range of all intrinsic parameters. Therefore, in certain cases a deviation from the provided data could occur.

LEDiL Oy reserves the right to undertake technical changes of its products without further notification which could lead to changes in the provided data. LEDiL Oy assumes no liability of any kind for the possible deviation from any provided data or any other damage resulting from the usage of the provided data.

The user agrees to this disclaimer and user agreement with the download or usage of the provided files.

#### LEDiL Oy

Joensuunkatu 13  
FI-24240 SALO  
Finland

#### LEDiL Inc.

228 West Page Street  
Suite D  
Sycamore IL 60178  
USA

#### Ledil Optics Technology (Shenzhen) Co., Ltd.

# 405 , Block B  
Casic Motor Building  
Shenzhen 518057  
P.R.CHINA

#### Local sales and technical support

[www.ledil.com/  
where\\_to\\_buy](http://www.ledil.com/where_to_buy)

#### Shipping locations

Poznan, Poland  
Hong Kong, China

#### Distribution Partners

[www.ledil.com/  
where\\_to\\_buy](http://www.ledil.com/where_to_buy)