

STRADA-SQ-FS-NP

Forward throw beam for area lighting.
Assembly with installation tape.

SPECIFICATION:

Dimensions	25.0 x 25.0 mm
Height	12.6 mm
Fastening	tape
ROHS compliant	yes ⓘ

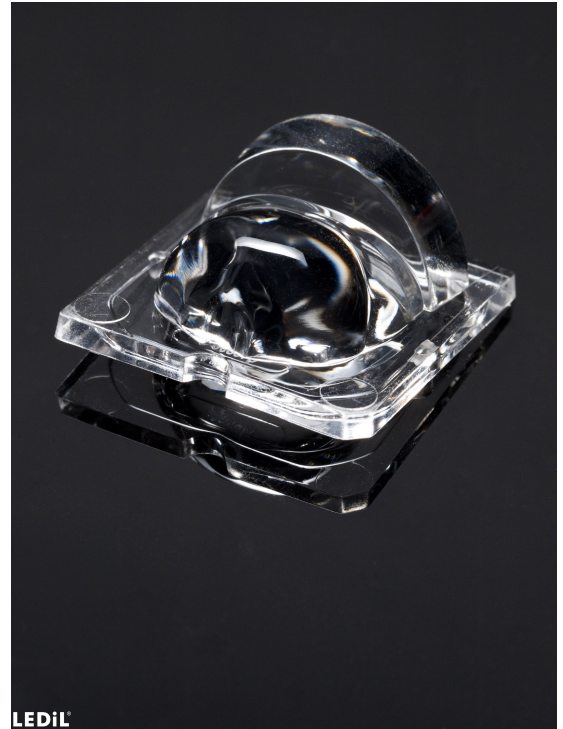

MATERIALS:

Component	Type	Material	Colour	Finish	Length (mm)
STRADA-SQ-FS-NP	Single lens	PMMA	clear		
ROSE-TAPE	Tape	Acrylic foam	black		

ORDERING INFORMATION:

Component	Type	Qty in box	MOQ	MPQ	Box weight (kg)
CA13758_STRADA-SQ-FS-NP » Box size: 480 x 280 x 300 mm	Single lens	1568	294	98	6.5

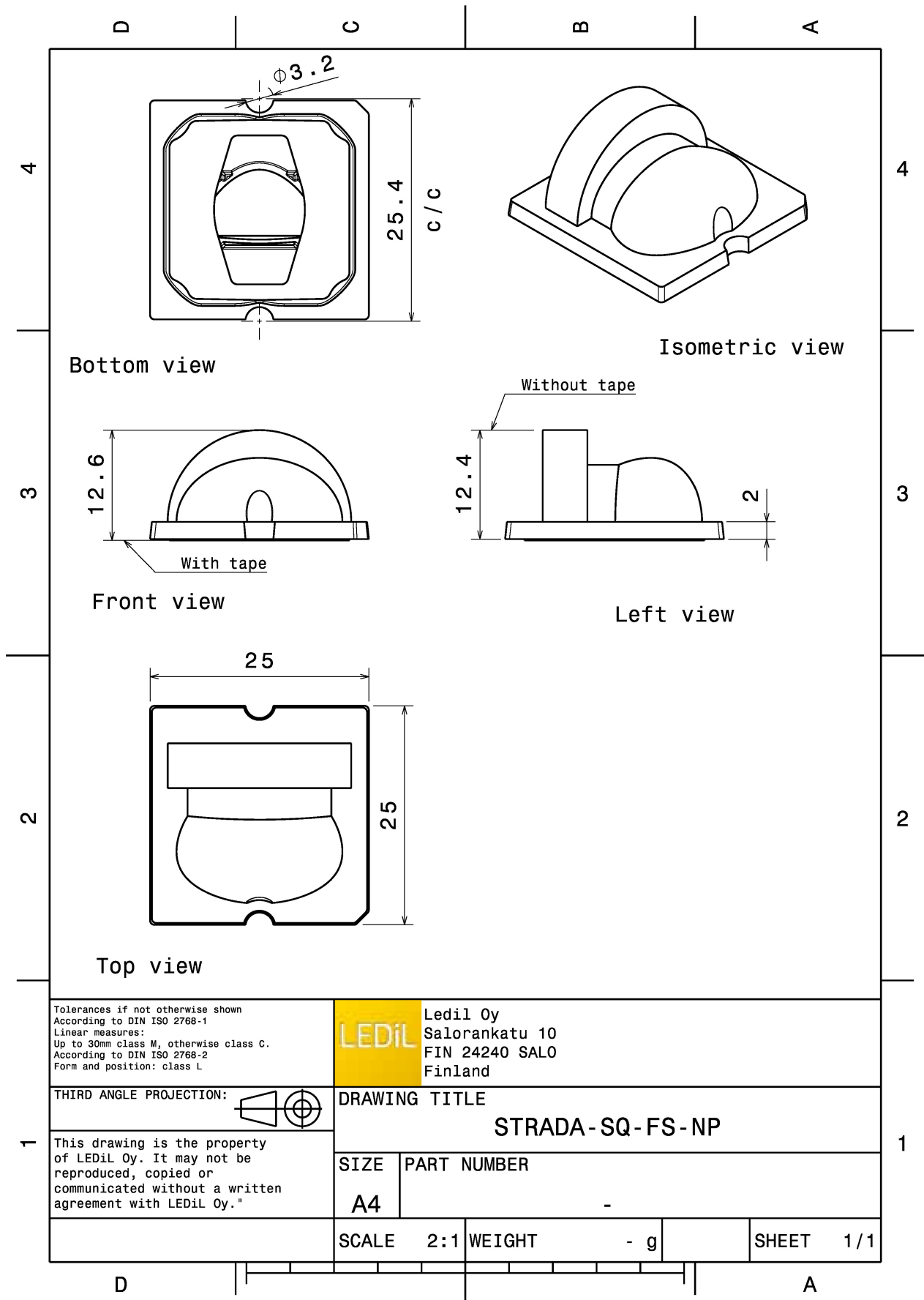

Tolerances if not otherwise shown According to DIN ISO 2768-1 Linear measures: Up to 30mm class M, otherwise class C. According to DIN ISO 2768-2 Form and position: class L		LEDiL LediL Oy Salorankatu 10 FIN 24240 SALO Finland	
THIRD ANGLE PROJECTION:		DRAWING TITLE STRADA-SQ-FS-NP	
This drawing is the property of LEDiL Oy. It may not be reproduced, copied or communicated without a written agreement with LEDiL Oy.		SIZE A4	PART NUMBER -
SCALE 2:1		WEIGHT - g	SHEET 1/1

See also our general installation guide: www.ledil.com/installation_guide

OPTICAL RESULTS (MEASURED):



LED MK-R
 FWHM / FWTM Asymmetric
 Efficiency 93 %
 Peak intensity 0.9 cd/lm
 LEDs/each optic 1
 Light colour/type White
 Required components:

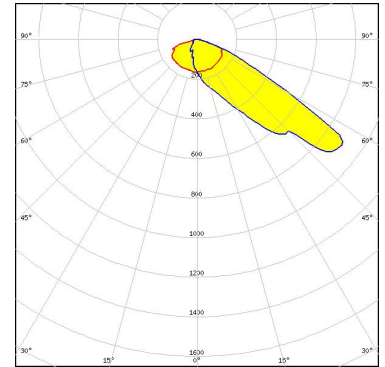

Light distribution files



LED XHP50
 FWHM / FWTM Asymmetric
 Efficiency 94 %
 Peak intensity 0.9 cd/lm
 LEDs/each optic 1
 Light colour/type White
 Required components:

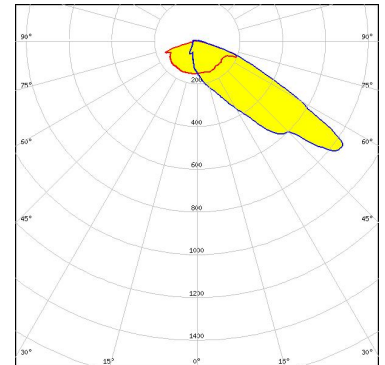

Light distribution files



LED XHP70
 FWHM / FWTM Asymmetric
 Efficiency 80 %
 Peak intensity 0.6 cd/lm
 LEDs/each optic 1
 Light colour/type White
 Required components:

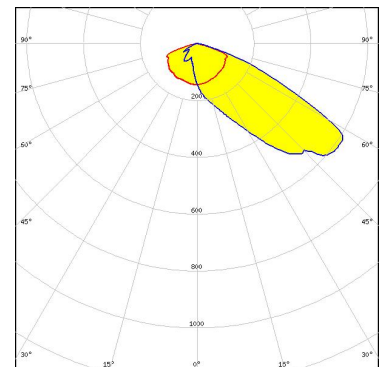

Protective plate, glass

Light distribution files

OPTICAL RESULTS (MEASURED):



LED XM-L
 FWHM / FWTM Asymmetric
 Efficiency 93 %
 Peak intensity 1.2 cd/lm
 LEDs/each optic 1
 Light colour/type White
 Required components:

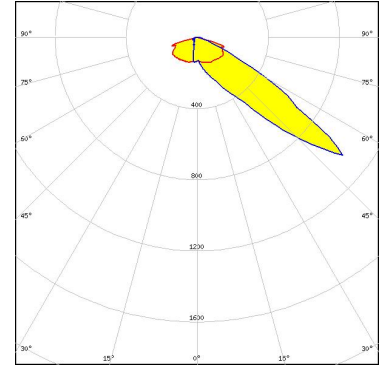

Light distribution files



LED XP-L HD
 FWHM / FWTM Asymmetric
 Efficiency 93 %
 Peak intensity 1.1 cd/lm
 LEDs/each optic 1
 Light colour/type White
 Required components:

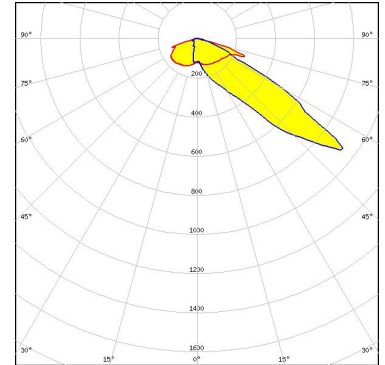

Light distribution files



LED XP-L2
 FWHM / FWTM Asymmetric
 Efficiency 93 %
 Peak intensity 1 cd/lm
 LEDs/each optic 1
 Light colour/type White
 Required components:

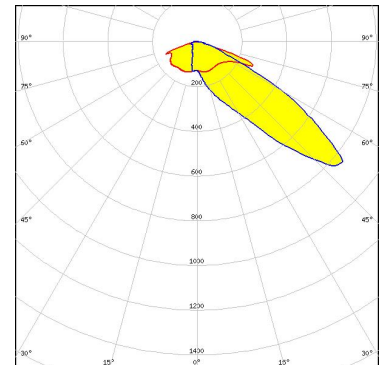

Light distribution files

OPTICAL RESULTS (MEASURED):



LED XT-E
 FWHM / FWTM Asymmetric
 Efficiency 93 %
 Peak intensity 1.2 cd/lm
 LEDs/each optic 1
 Light colour/type White
 Required components:

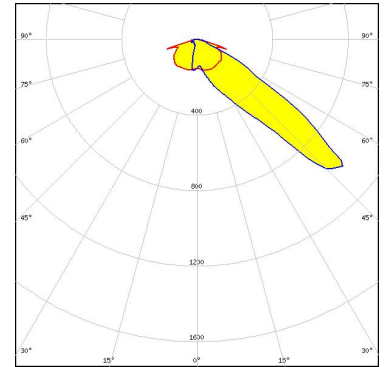

Light distribution files



LED LUXEON M/MX
 FWHM / FWTM Asymmetric
 Efficiency 92 %
 Peak intensity 0.9 cd/lm
 LEDs/each optic 1
 Light colour/type White
 Required components:

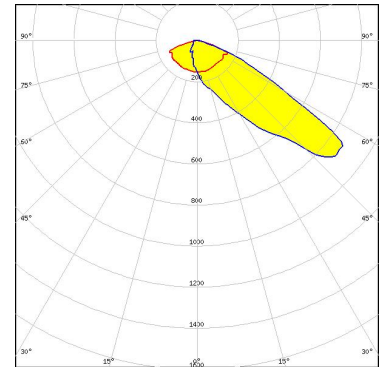

Light distribution files



LED LUXEON MZ
 FWHM / FWTM Asymmetric
 Efficiency 93 %
 Peak intensity 1.2 cd/lm
 LEDs/each optic 1
 Light colour/type White
 Required components:

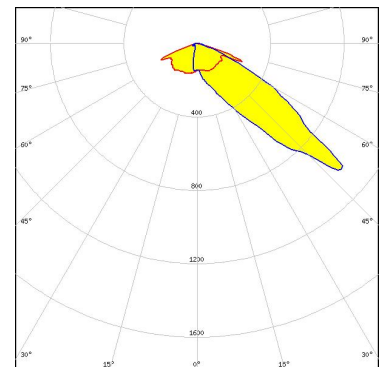

Light distribution files

OPTICAL RESULTS (MEASURED):



LED LUXEON XR-M Linear (L2M0-xxxx003MC3300)
FWHM / FWTM Asymmetric
Efficiency 94 %
Peak intensity 1 cd/lm
LEDs/each optic 1
Light colour/type White
Required components:

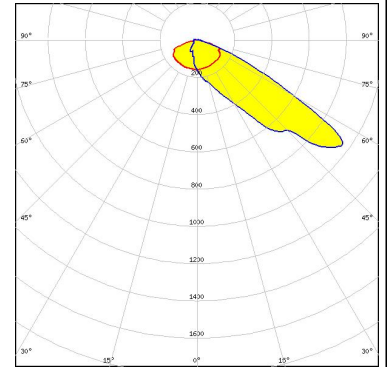

Light distribution files



LED Duris S10
FWHM / FWTM Asymmetric
Efficiency 92 %
Peak intensity 0.9 cd/lm
LEDs/each optic 1
Light colour/type White
Required components:

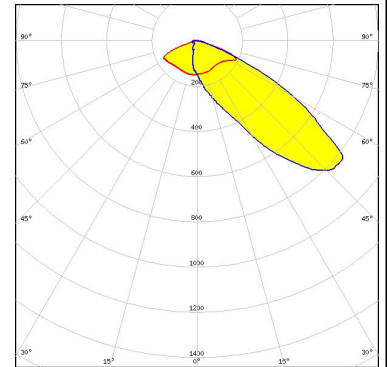

Light distribution files

OPTICAL RESULTS (SIMULATED):



LED J Series 7070B K Class
 FWHM / FWTM Asymmetric
 Efficiency 80 %
 Peak intensity 0.7 cd/lm
 LEDs/each optic 1
 Light colour/type White
 Required components:

Protective plate, glass

Light distribution files

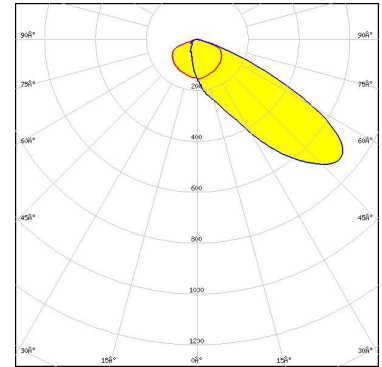

LED J Series 7070B K Class
 FWHM / FWTM Asymmetric
 Efficiency 93 %
 Peak intensity 0.8 cd/lm
 LEDs/each optic 1
 Light colour/type White
 Required components:

Light distribution files

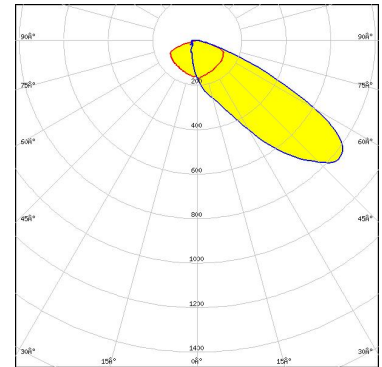

LED XM-L2
 FWHM / FWTM Asymmetric
 Efficiency 93 %
 Peak intensity 1.1 cd/lm
 LEDs/each optic 1
 Light colour/type White
 Required components:

Light distribution files

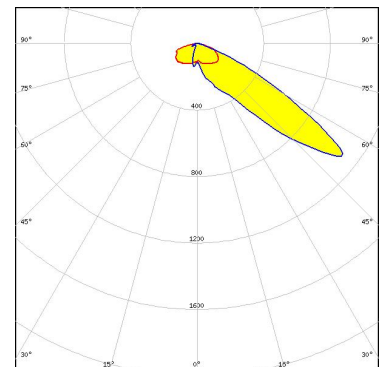

OPTICAL RESULTS (SIMULATED):



LED LUXEON 5050 Round LES
 FWHM / FWTM Asymmetric
 Efficiency 97 %
 Peak intensity 1.1 cd/lm
 LEDs/each optic 1
 Light colour/type White
 Required components:

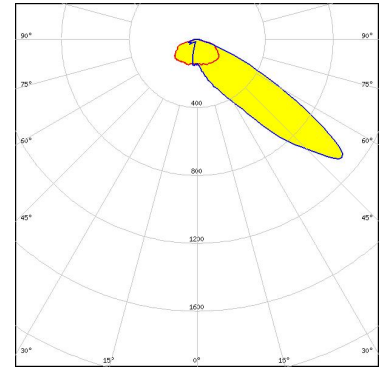

Light distribution files



LED LUXEON 7070
 FWHM / FWTM Asymmetric
 Efficiency 81 %
 Peak intensity 0.7 cd/lm
 LEDs/each optic 1
 Light colour/type White
 Required components:

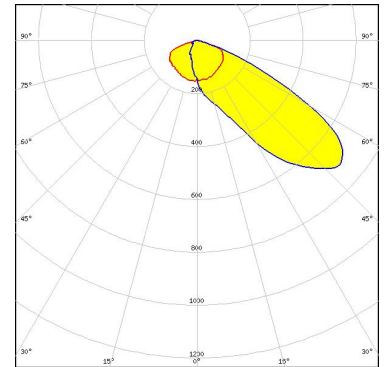

Protective plate, glass

Light distribution files



LED OSCONIQ P 7070
 FWHM / FWTM Asymmetric
 Efficiency 90 %
 Peak intensity 1 cd/lm
 LEDs/each optic 1
 Light colour/type White
 Required components:

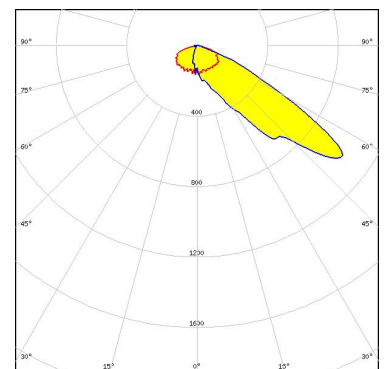

Light distribution files

GENERAL INFORMATION:

NOTE: The typical beam angle will be changed by different color, chip size and chip position tolerance. The typical total beam angle is the full angle measured where the luminous intensity is half of the peak value.

MATERIALS:

As part of our continuous research and improvement processes, and to ensure the best possible quality and availability of our products, LEDiL reserves the right to change material grades without notice.

PRODUCT DATA USER AGREEMENT AND DISCLAIMER:

The measured data in the provided downloadable LEDiL Product Datasheets and Mechanical 2D-Drawings is rounded and provided as reference for planning. LEDiL Oy's optical specifications have been verified by conducting performance testing of the products in accordance with the company's quality system. The reported data are averaged results of multiple measurements with typical variation. LEDiL Oy reserves the right to without prior notification make changes and improvements to its products.

LEDiL Oy assumes neither warranty, nor guarantee nor any other liability of any kind for the contents and correctness of the provided data. The provided data has been generated with highest diligence but the provided data may in reality not represent the complete possible variation range of all intrinsic parameters. Therefore, in certain cases a deviation from the provided data could occur.

LEDiL Oy reserves the right to undertake technical changes of its products without further notification which could lead to changes in the provided data. LEDiL Oy assumes no liability of any kind for the possible deviation from any provided data or any other damage resulting from the usage of the provided data.

The user agrees to this disclaimer and user agreement with the download or usage of the provided files.

LEDiL Oy

Joensuunkatu 13
FI-24240 SALO
Finland

LEDiL Inc.

228 West Page Street
Suite D
Sycamore IL 60178
USA

Ledil Optics Technology (Shenzhen) Co., Ltd.

405 , Block B
Casic Motor Building
Shenzhen 518057
P.R.CHINA

Local sales and technical support

[www.ledil.com/
where_to_buy](http://www.ledil.com/where_to_buy)

Shipping locations

Poznan, Poland
Hong Kong, China

Distribution Partners

[www.ledil.com/
where_to_buy](http://www.ledil.com/where_to_buy)