

## STRADA-SQ-FS2

Beam for symmetrical tunnel lighting and parking garages. Ideal for catenary street lighting. Version with location pins. Assembly with installation tape.

### SPECIFICATION:

Dimensions	25.0 x 25.0 mm
Height	8.2 mm
Fastening	tape, pin
ROHS compliant	yes ⓘ



### MATERIALS:

Component	Type	Material	Colour	Finish	Length (mm)
STRADA-SQ-FS2	Single lens	PMMA	clear		
ROSE-TAPE	Tape	Acrylic foam	black		

### ORDERING INFORMATION:

Component		Qty in box	MOQ	MPQ	Box weight (kg)
CA14120_STRADA-SQ-FS2	Single lens	2058	294	98	7.3
» Box size: 480 x 280 x 300 mm					

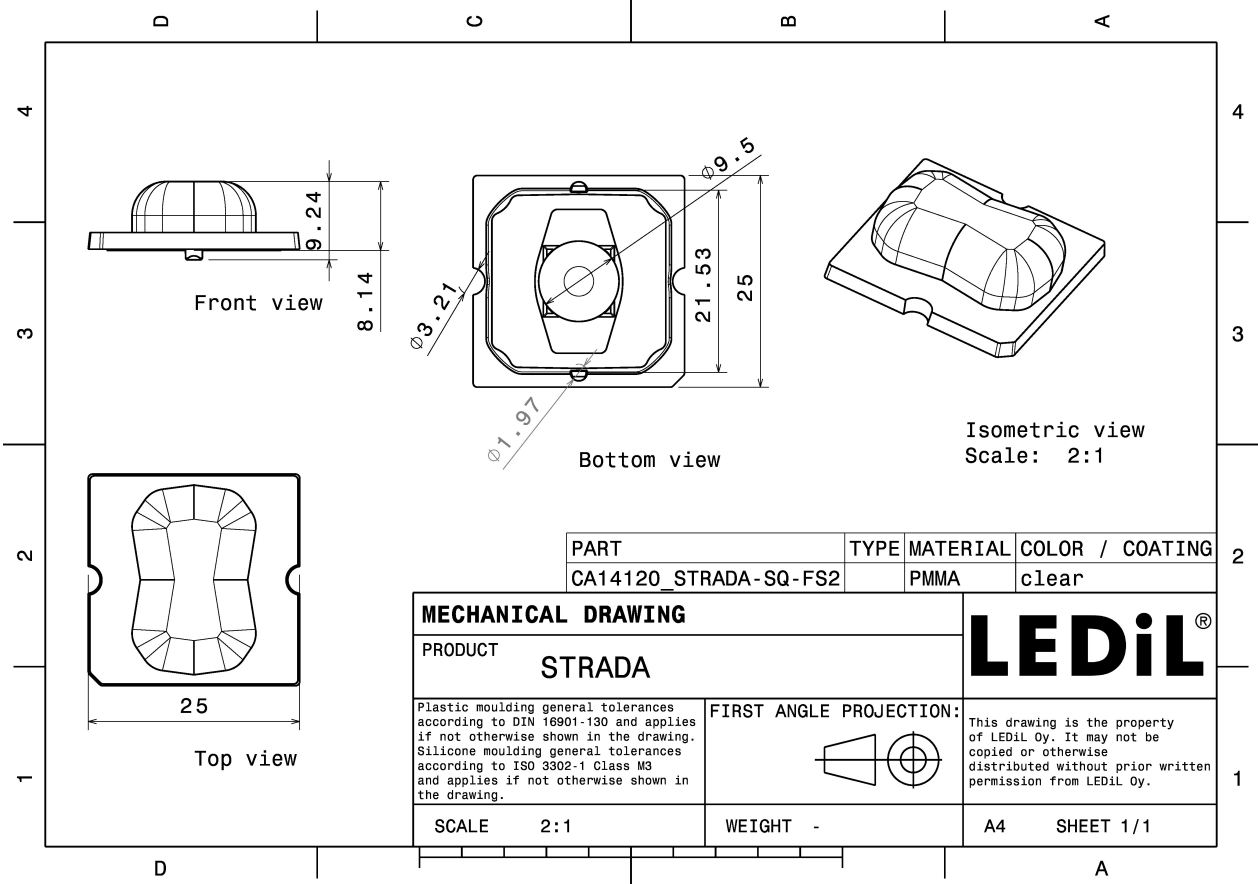

See also our general installation guide: [www.ledil.com/installation\\_guide](http://www.ledil.com/installation_guide)

#### OPTICAL RESULTS (MEASURED):



LED MK-R  
 FWHM / FWTM Asymmetric  
 Efficiency 81 %  
 Peak intensity 0.4 cd/lm  
 LEDs/each optic 1  
 Light colour/type White  
 Required components:

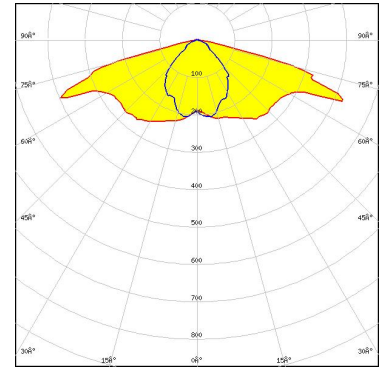

Light distribution files



LED XHP70  
 FWHM / FWTM Asymmetric  
 Efficiency 78 %  
 Peak intensity 0.4 cd/lm  
 LEDs/each optic 1  
 Light colour/type White  
 Required components:

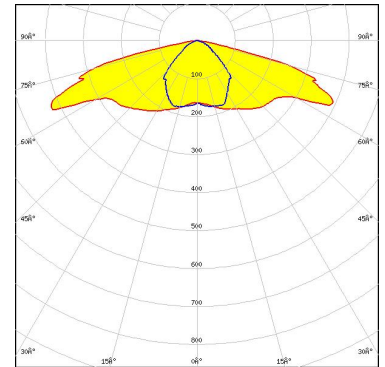

Protective plate, glass

Light distribution files



LED LUXEON M/MX  
 FWHM / FWTM Asymmetric  
 Efficiency 81 %  
 Peak intensity 0.4 cd/lm  
 LEDs/each optic 1  
 Light colour/type White  
 Required components:

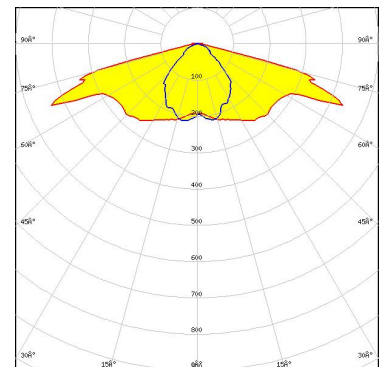

Protective plate, glass

Light distribution files

#### OPTICAL RESULTS (MEASURED):



LED LUXEON XR-M Linear (L2M0-xxxx003MC3300)  
FWHM / FWTM Asymmetric  
Efficiency 92 %  
Peak intensity 0.6 cd/lm  
LEDs/each optic 1  
Light colour/type White  
Required components:

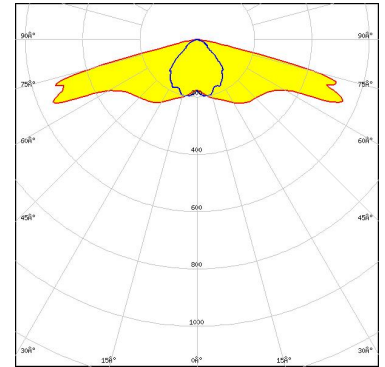

Light distribution files



LED NVSW319B  
FWHM / FWTM Asymmetric  
Efficiency 93 %  
Peak intensity 0.8 cd/lm  
LEDs/each optic 1  
Light colour/type White  
Required components:

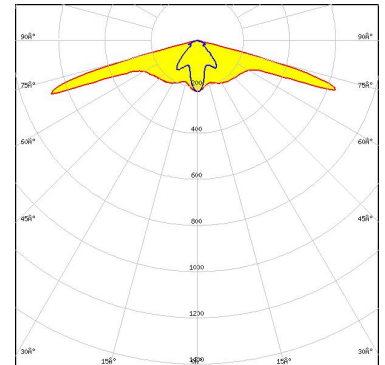

Light distribution files



LED Duris S10  
FWHM / FWTM Asymmetric  
Efficiency 88 %  
Peak intensity 0.6 cd/lm  
LEDs/each optic 1  
Light colour/type White  
Required components:

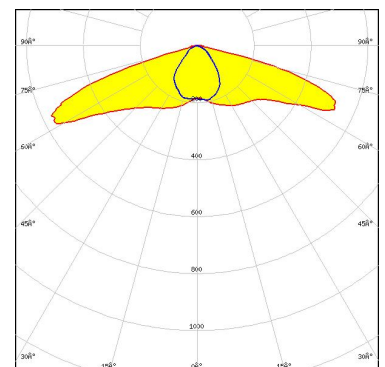

Light distribution files

#### OPTICAL RESULTS (MEASURED):

**OSRAM**  
Opto Semiconductors

LED	Duris S8
FWHM / FWTM	Asymmetric
Efficiency	91 %
Peak intensity	0.7 cd/lm
LEDs/each optic	1
Light colour/type	White
Required components:	

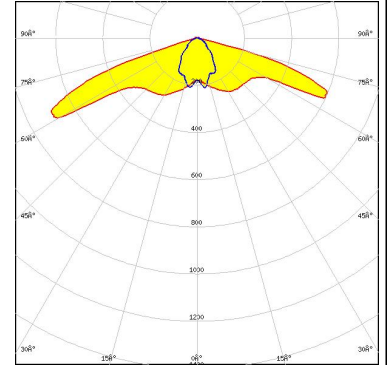

Light distribution files

#### OPTICAL RESULTS (SIMULATED):



LED J Series 7070B K Class  
 FWHM / FWTM Asymmetric  
 Efficiency 76 %  
 Peak intensity 0.4 cd/lm  
 LEDs/each optic 1  
 Light colour/type White  
 Required components:

Protective plate, glass

Light distribution files

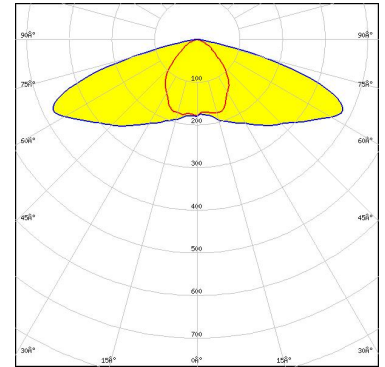

LED J Series 7070B K Class  
 FWHM / FWTM Asymmetric  
 Efficiency 89 %  
 Peak intensity 0.5 cd/lm  
 LEDs/each optic 1  
 Light colour/type White  
 Required components:

Light distribution files

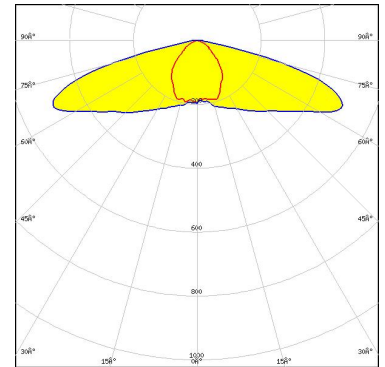

LED MHB-A/B  
 FWHM / FWTM Asymmetric  
 Efficiency 89 %  
 Peak intensity 0.5 cd/lm  
 LEDs/each optic 1  
 Light colour/type White  
 Required components:

Light distribution files

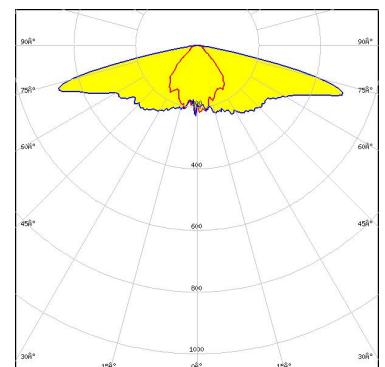

#### OPTICAL RESULTS (SIMULATED):



LED XM-L  
FWHM / FWTM Asymmetric  
Efficiency 92 %  
Peak intensity 0.7 cd/lm  
LEDs/each optic 1  
Light colour/type White  
Required components:

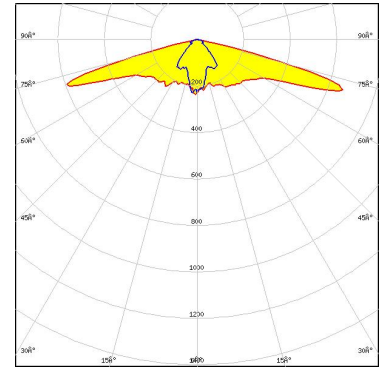

Light distribution files



LED XM-L2  
FWHM / FWTM Asymmetric  
Efficiency 90 %  
Peak intensity 0.7 cd/lm  
LEDs/each optic 1  
Light colour/type White  
Required components:

Light distribution files



LED LUXEON 7070  
FWHM / FWTM Asymmetric  
Efficiency 81 %  
Peak intensity 0.4 cd/lm  
LEDs/each optic 1  
Light colour/type White  
Required components:

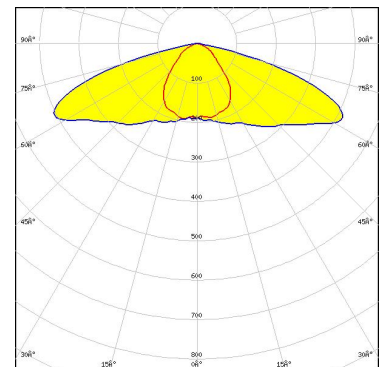

Protective plate, glass

Light distribution files

#### OPTICAL RESULTS (SIMULATED):



LED LUXEON T  
FWHM / FWTM Asymmetric  
Efficiency 94 %  
Peak intensity 0.6 cd/lm  
LEDs/each optic 1  
Light colour/type White  
Required components:

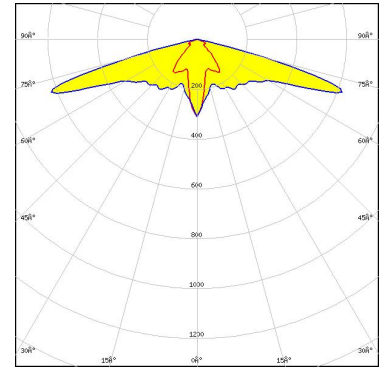

Light distribution files



LED LH351B  
FWHM / FWTM Asymmetric  
Efficiency 92 %  
Peak intensity 0.6 cd/lm  
LEDs/each optic 1  
Light colour/type White  
Required components:

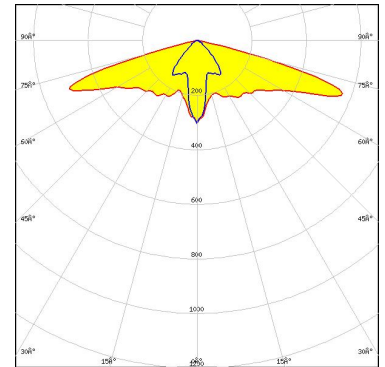

Light distribution files



### GENERAL INFORMATION:

NOTE: The typical beam angle will be changed by different color, chip size and chip position tolerance. The typical total beam angle is the full angle measured where the luminous intensity is half of the peak value.

### MATERIALS:

As part of our continuous research and improvement processes, and to ensure the best possible quality and availability of our products, LEDiL reserves the right to change material grades without notice.

### PRODUCT DATA USER AGREEMENT AND DISCLAIMER:

The measured data in the provided downloadable LEDiL Product Datasheets and Mechanical 2D-Drawings is rounded and provided as reference for planning. LEDiL Oy's optical specifications have been verified by conducting performance testing of the products in accordance with the company's quality system. The reported data are averaged results of multiple measurements with typical variation. LEDiL Oy reserves the right to without prior notification make changes and improvements to its products.

LEDiL Oy assumes neither warranty, nor guarantee nor any other liability of any kind for the contents and correctness of the provided data. The provided data has been generated with highest diligence but the provided data may in reality not represent the complete possible variation range of all intrinsic parameters. Therefore, in certain cases a deviation from the provided data could occur.

LEDiL Oy reserves the right to undertake technical changes of its products without further notification which could lead to changes in the provided data. LEDiL Oy assumes no liability of any kind for the possible deviation from any provided data or any other damage resulting from the usage of the provided data.

The user agrees to this disclaimer and user agreement with the download or usage of the provided files.

#### LEDiL Oy

Joensuunkatu 13  
FI-24240 SALO  
Finland

#### LEDiL Inc.

228 West Page Street  
Suite D  
Sycamore IL 60178  
USA

#### Ledil Optics Technology (Shenzhen) Co., Ltd.

# 405 , Block B  
Casic Motor Building  
Shenzhen 518057  
P.R.CHINA

#### Local sales and technical support

[www.ledil.com/  
where\\_to\\_buy](http://www.ledil.com/where_to_buy)

#### Shipping locations

Poznan, Poland  
Hong Kong, China

#### Distribution Partners

[www.ledil.com/  
where\\_to\\_buy](http://www.ledil.com/where_to_buy)