

## TINA3-W

~40° wide beam optimized for CREE XP-E.  
Assembly with holder, installation tape and  
location pins.

### SPECIFICATION:

Dimensions	Ø 16.1
Height	6.9 mm
Fastening	tape, pin
ROHS compliant	yes ⓘ



### MATERIALS:

Component	Type	Material	Colour	Finish	Length (mm)
TINA3-W	Single lens	PMMA	clear		
TINA3-HLD-PIN-TAPE-XP	Holder	PC	white		
TINA-TAPE3	Tape	Acrylic foam	black		

### ORDERING INFORMATION:

Component	Qty in box	MOQ	MPQ	Box weight (kg)
FA11824_TINA3-W » Box size:	2016	288	288	3.2

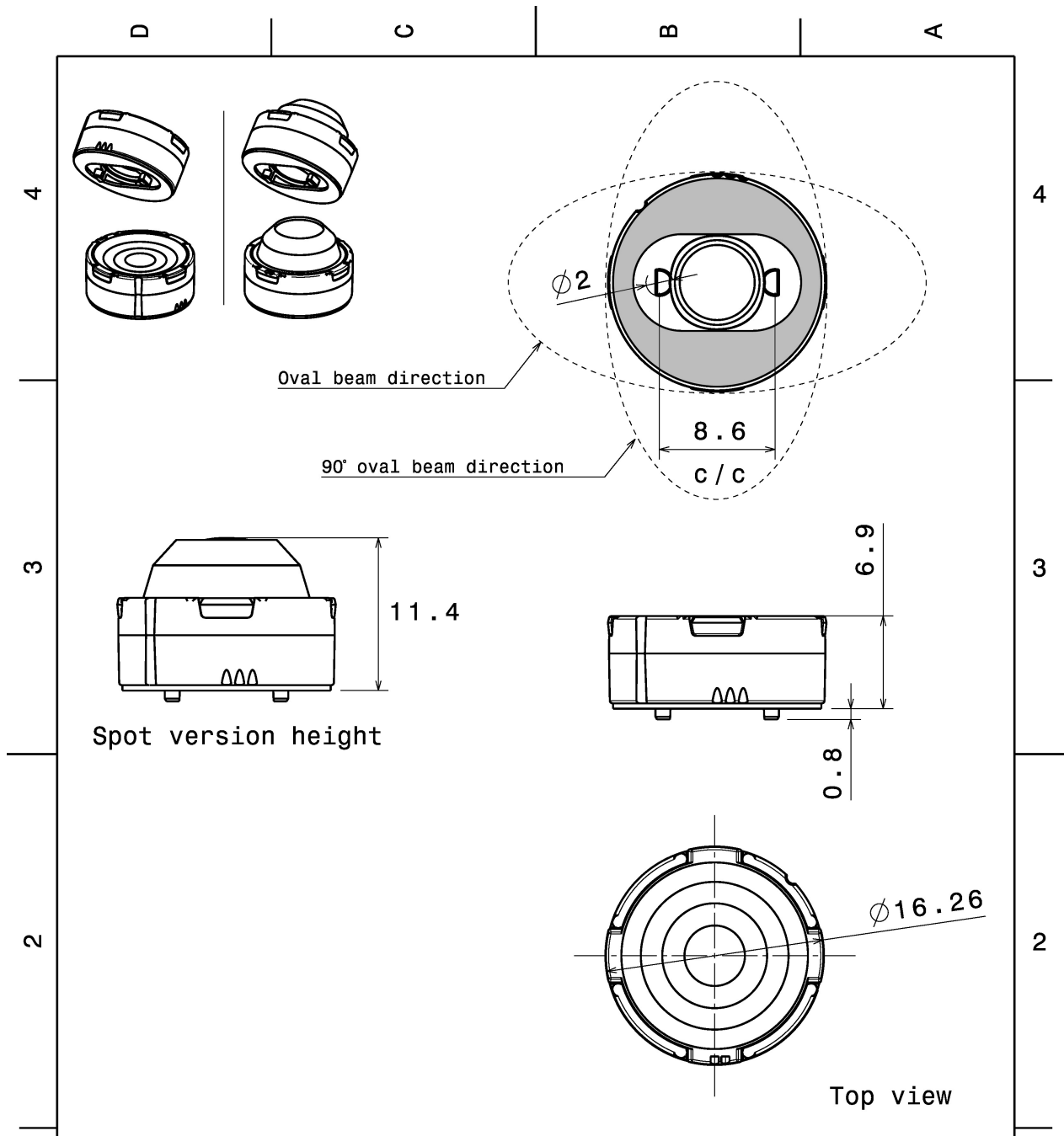

Tolerances if not otherwise shown  
According to DIN ISO 2768-1  
Linear measures:  
Up to 30mm class F, otherwise class M.  
According to DIN ISO 2768-2  
Form and position: class K

**LEDiL** Ledil Oy  
Salorankatu 10  
FIN 24240 SALO  
Finland

THIRD ANGLE PROJECTION:

DRAWING TITLE  
**TINA3 Datasheet**

This drawing is the property of LEDiL Oy. It may not be reproduced, copied or communicated without a written agreement with LEDiL Oy."

SIZE	PART NUMBER
A4	-

SCALE	4:3	WEIGHT	-	SHEET	1/1
-------	-----	--------	---	-------	-----

See also our general installation guide: [www.ledil.com/installation\\_guide](http://www.ledil.com/installation_guide)

### OPTICAL RESULTS (MEASURED):



LED XB-D  
FWHM / FWTM 40.0° / 64.0°  
Efficiency 91 %  
Peak intensity 1.5 cd/lm  
LEDs/each optic 1  
Light colour/type White  
Required components:



LED XP-E  
FWHM / FWTM 41.0° / 60.0°  
Efficiency 93 %  
Peak intensity 1.8 cd/lm  
LEDs/each optic 1  
Light colour/type White  
Required components:



LED XP-G  
FWHM / FWTM 32.0° / 64.0°  
Efficiency 93 %  
Peak intensity 1.5 cd/lm  
LEDs/each optic 1  
Light colour/type White  
Required components:

### OPTICAL RESULTS (MEASURED):



LED XP-L HI  
FWHM / FWTM 43.0° / 68.0°  
Efficiency 91 %  
Peak intensity 1.6 cd/lm  
LEDs/each optic 1  
Light colour/type White  
Required components:

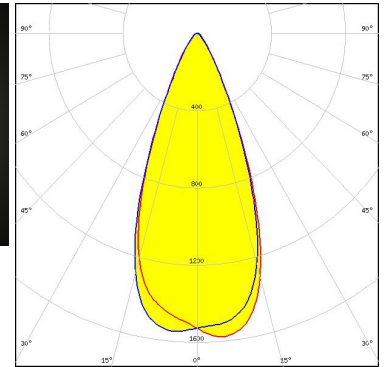
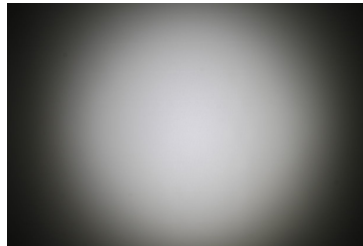

Light distribution files



LED LUXEON A  
FWHM / FWTM 44.0° / 72.0°  
Efficiency 90 %  
Peak intensity 1.4 cd/lm  
LEDs/each optic 1  
Light colour/type White  
Required components:

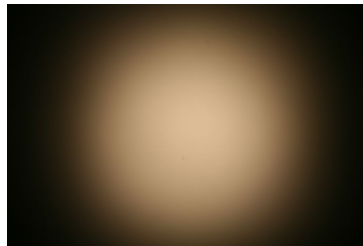

Light distribution files



LED LUXEON Rebel  
FWHM / FWTM 38.0° / 62.0°  
Efficiency 83 %  
Peak intensity 1.7 cd/lm  
LEDs/each optic 1  
Light colour/type White  
Required components:

### OPTICAL RESULTS (MEASURED):

#### LUMILEDS

LED	LUXEON Rebel ES
FWHM / FWTM	45.0° / 68.0°
Efficiency	91 %
Peak intensity	1.3 cd/lm
LEDs/each optic	1
Light colour/type	White
Required components:	

#### NICHIA

LED	NVSxx19A
FWHM / FWTM	41.0° / 68.0°
Efficiency	93 %
Peak intensity	1.4 cd/lm
LEDs/each optic	1
Light colour/type	White
Required components:	

#### OSRAM Opto Semiconductors

LED	OSLON SSL 150
FWHM / FWTM	37.0° / 60.0°
Efficiency	89 %
Peak intensity	2 cd/lm
LEDs/each optic	1
Light colour/type	White
Required components:	

### OPTICAL RESULTS (MEASURED):

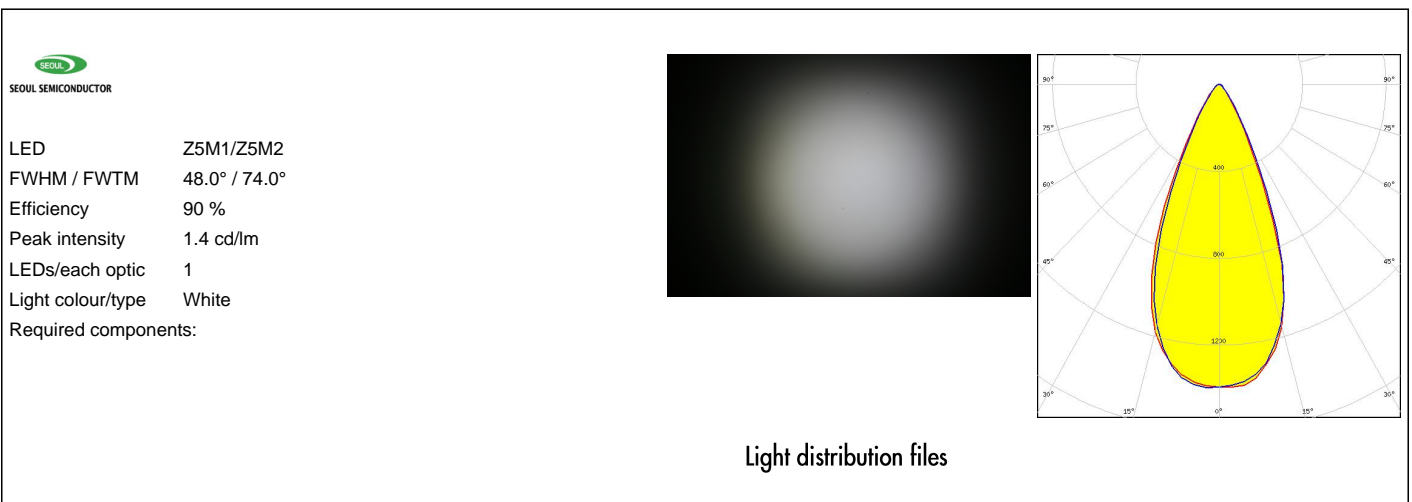

### OPTICAL RESULTS (SIMULATED):



LED NCSxE17A  
 FWHM / FWTM 36.0° / 58.0°  
 Efficiency 81 %  
 Peak intensity 1.9 cd/lm  
 LEDs/each optic 1  
 Light colour/type White  
 Required components:

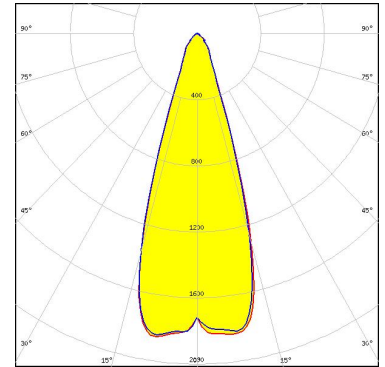

Light distribution files



LED NCSxx19A  
 FWHM / FWTM 39.0° / 56.0°  
 Efficiency 91 %  
 Peak intensity 1.8 cd/lm  
 LEDs/each optic 1  
 Light colour/type White  
 Required components:

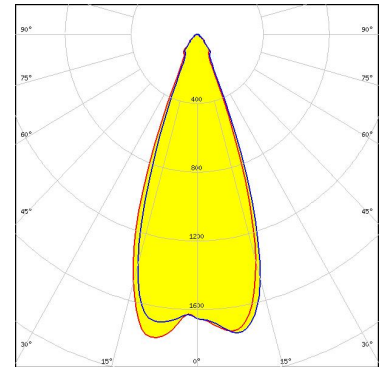

Light distribution files



LED SYNIOS S2222  
 FWHM / FWTM 38.0 + 36.0° / 54.0°  
 Efficiency 96 %  
 Peak intensity 2 cd/lm  
 LEDs/each optic 1  
 Light colour/type White  
 Required components:

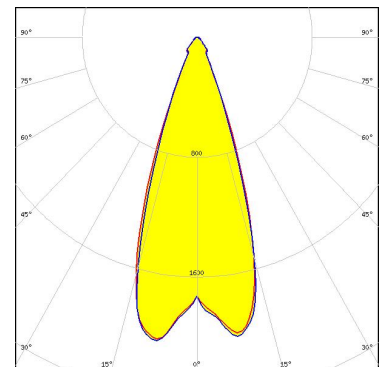

Light distribution files

### OPTICAL RESULTS (SIMULATED):

 SEOUL SEMICONDUCTOR	
LED	Z8Y22P
FWHM / FWTM	42.0°
Efficiency	94 %
Peak intensity	1.6 cd/lm
LEDs/each optic	1
Light colour/type	White
Required components:	

Light distribution files

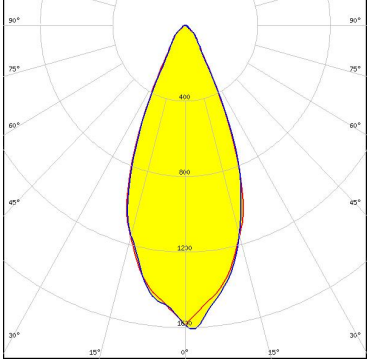



### GENERAL INFORMATION:

NOTE: The typical beam angle will be changed by different color, chip size and chip position tolerance. The typical total beam angle is the full angle measured where the luminous intensity is half of the peak value.

### MATERIALS:

As part of our continuous research and improvement processes, and to ensure the best possible quality and availability of our products, LEDiL reserves the right to change material grades without notice.

### PRODUCT DATA USER AGREEMENT AND DISCLAIMER:

The measured data in the provided downloadable LEDiL Product Datasheets and Mechanical 2D-Drawings is rounded and provided as reference for planning. LEDiL Oy's optical specifications have been verified by conducting performance testing of the products in accordance with the company's quality system. The reported data are averaged results of multiple measurements with typical variation. LEDiL Oy reserves the right to without prior notification make changes and improvements to its products.

LEDiL Oy assumes neither warranty, nor guarantee nor any other liability of any kind for the contents and correctness of the provided data. The provided data has been generated with highest diligence but the provided data may in reality not represent the complete possible variation range of all intrinsic parameters. Therefore, in certain cases a deviation from the provided data could occur.

LEDiL Oy reserves the right to undertake technical changes of its products without further notification which could lead to changes in the provided data. LEDiL Oy assumes no liability of any kind for the possible deviation from any provided data or any other damage resulting from the usage of the provided data.

The user agrees to this disclaimer and user agreement with the download or usage of the provided files.

#### LEDiL Oy

Joensuunkatu 7  
FI-24240 SALO  
Finland

#### LEDiL Inc.

228 West Page Street  
Suite D  
Sycamore IL 60178  
USA

#### Ledil Optics Technology (Shenzhen) Co., Ltd.

# 405 , Block B  
Casic Motor Building  
Shenzhen 518057  
P.R.CHINA

#### Local sales and technical support

[www.ledil.com/  
where\\_to\\_buy](http://www.ledil.com/where_to_buy)

#### Shipping locations

Poznan, Poland  
Hong Kong, China

#### Distribution Partners

[www.ledil.com/  
where\\_to\\_buy](http://www.ledil.com/where_to_buy)