

Bottom view

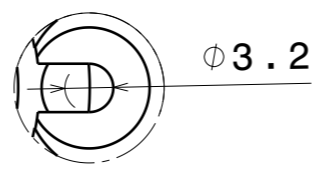

Detail A

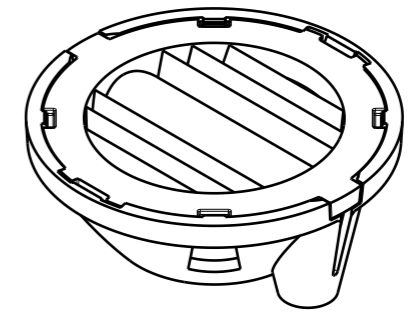

Isometric view

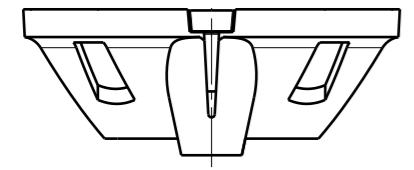

Right view

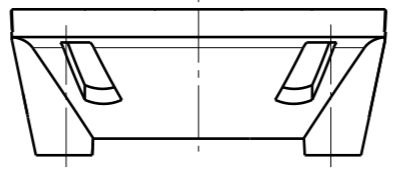

Front view

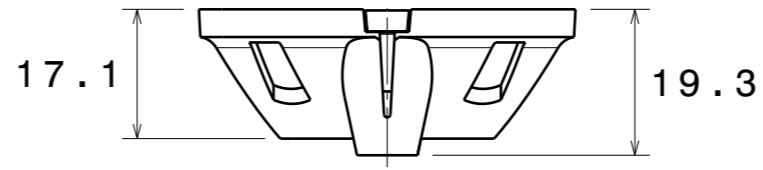

Left view

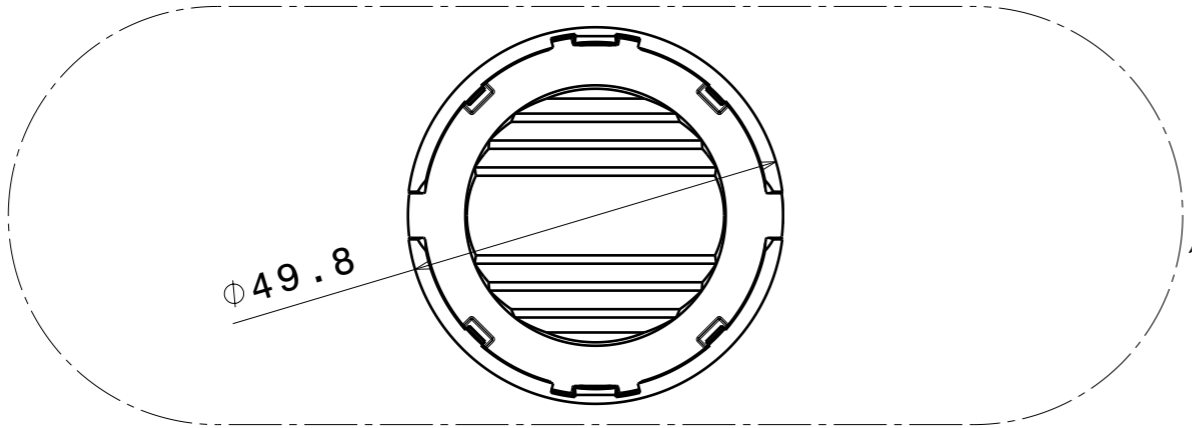

Top view

Oval beam direction

| INDEX | PART | TYPE | MATERIAL | COLOR / COATING |
|-------|----------------------|--------|----------|-----------------|
| 1 | C14235_WINNIE-HOLDER | HOLDER | PC | WHITE |
| 2 | C14760_WINNIE-O | LENS | PMMA | CLEAR |

MECHANICAL DRAWING

PRODUCT
WINNIE



Plastic moulding general tolerances according to DIN 16901-130 and applies if not otherwise shown in the drawing.
Silicone moulding general tolerances according to ISO 3302-1 Class M3 and applies if not otherwise shown in the drawing.

FIRST ANGLE PROJECTION:

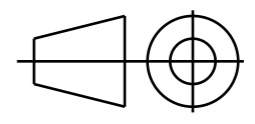

This drawing is the property of LEDiL Oy. It may not be copied or otherwise distributed without prior written permission from LEDiL Oy.

| | | | | | |
|-------|-----|--------|---|----|-----------|
| SCALE | 1:1 | WEIGHT | - | A3 | SHEET 1/1 |
|-------|-----|--------|---|----|-----------|

Notes

Ensure LED fitting from a product specific 3D model available from www.ledil.com
For more details about installation please see LEDiL Installation Guide on www.ledil.com