

YASMEEN-70-M

~26° wide beam

SPECIFICATION:

Dimensions	Ø 70.0
Height	37.7 mm
Fastening	socket
ROHS compliant	yes ⓘ

MATERIALS:

Component	Type	Material	Colour	Finish	Length
YASMEEN-70-M	Single lens	PMMA	clear		69.9
YASMEEN-70-HLD2-C	Holder C	PC	black		
YASMEEN-70-HLD2-B	Holder B	PC	black		
YASMEEN-70-HLD2-C-WHT	Holder C	PC	white		
YASMEEN-70-HLD2-B-WHT	Holder B	PC	white		



ORDERING INFORMATION:

Component	Qty in box	MOQ	MPQ	Box weight (kg)
C17239_YASMEEN-70-M	105	105	15	8.4
Assembly				
CP18783_YASMEEN-70-M-B2-WHT	105	105	15	9.9
CP18776_YASMEEN-70-M-C2-WHT	105	105	15	9.8
CP18769_YASMEEN-70-M-B2	105	105	15	9.9
CP18762_YASMEEN-70-M-C2	105	105	15	9.8

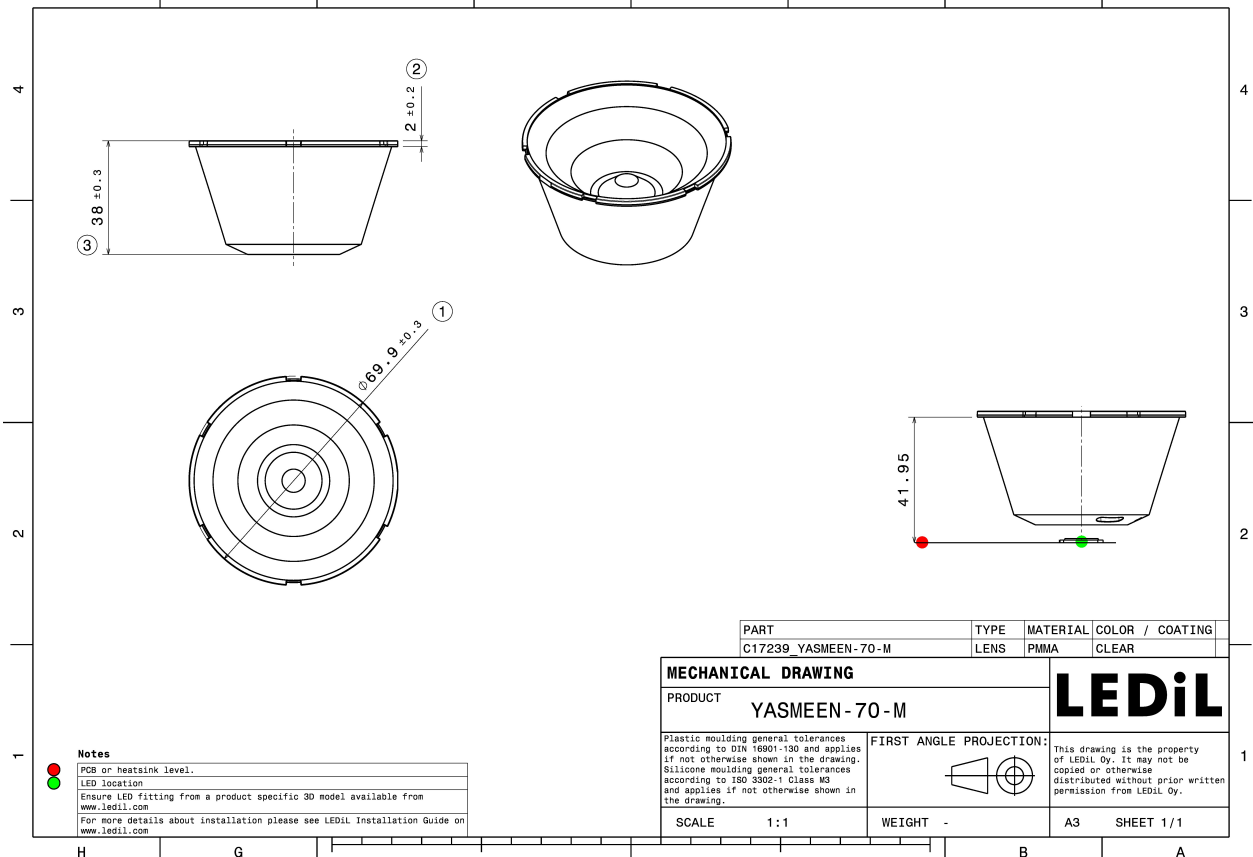
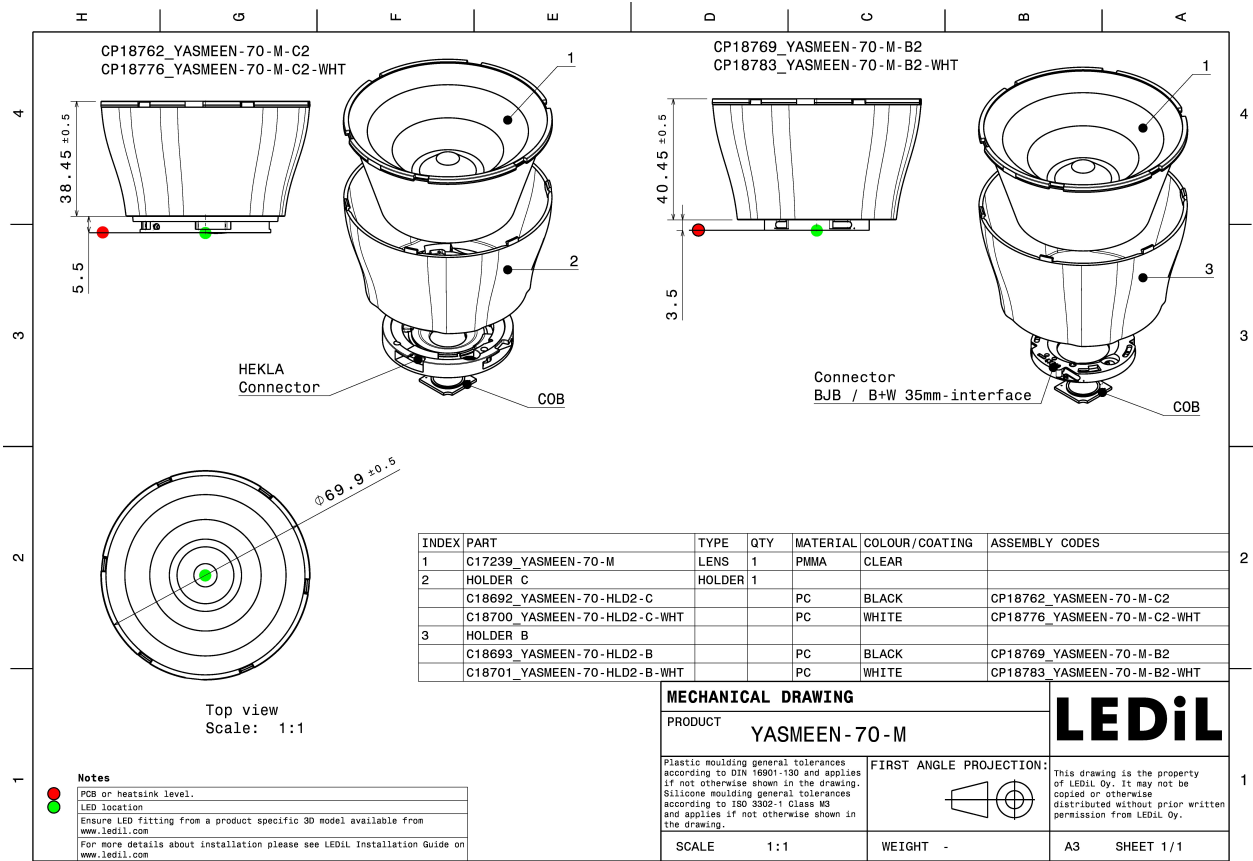

See also our general installation guide: www.ledil.com/installation_guide

OPTICAL RESULTS (MEASURED):



LED V10 Gen 8-9
Ordering code CP18762_YASMEEN-70-M-C2
FWHM / FWTM 26.0° / 44.0°
Efficiency 84 %
Peak intensity 3.7 cd/lm
LEDs/each optic 1
Light colour/type White
Required components:
 F15255_HEKLA-SOCKET-C

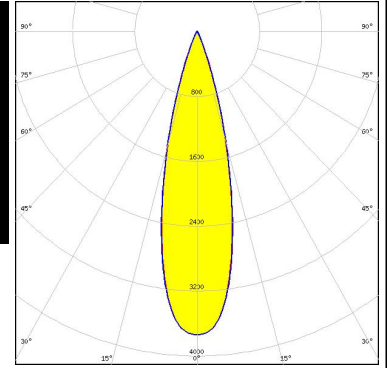
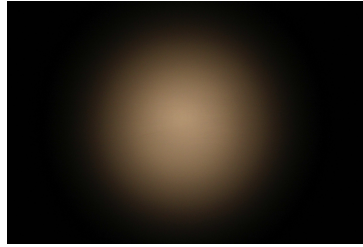

LED V11 HD Gen 8
Ordering code CP18762_YASMEEN-70-M-C2
FWHM / FWTM 25.0° / 44.0°
Efficiency 82 %
Peak intensity 3.8 cd/lm
LEDs/each optic 1
Light colour/type White
Required components:
 Bender Wirth: 633d Hekla

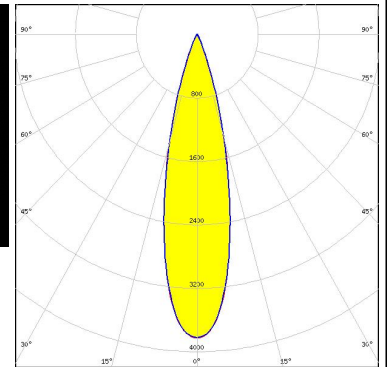



LED V11 HD Gen 8
Ordering code CP18776_YASMEEN-70-M-C2-WHT
FWHM / FWTM 24.0° / 42.0°
Efficiency 90 %
Peak intensity 4.2 cd/lm
LEDs/each optic 1
Light colour/type White
Required components:
Bender Wirth: 633d Hekla

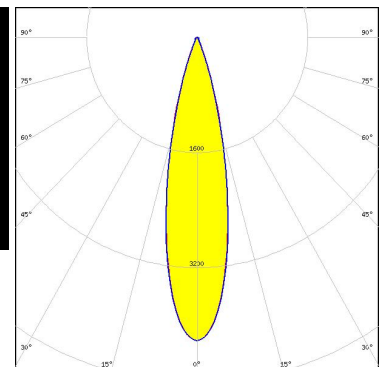
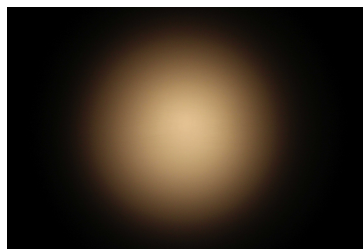

OPTICAL RESULTS (MEASURED):



LED V13 Gen 8-9
Ordering code CP18762_YASMEEN-70-M-C2
FWHM / FWTM 26.0° / 47.0°
Efficiency 81 %
Peak intensity 3.4 cd/lm
LEDs/each optic 1
Light colour/type White
Required components:
 F15859_HEKLA-SOCKET-I

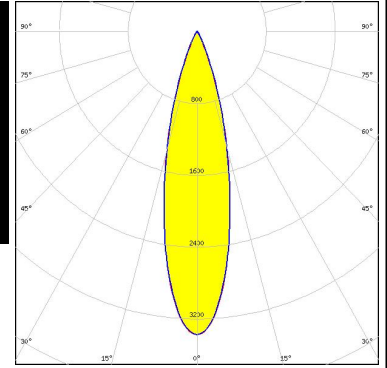

LED V8 Gen 8-9
Ordering code CP18762_YASMEEN-70-M-C2
FWHM / FWTM 27.0° / 43.0°
Efficiency 85 %
Peak intensity 3.7 cd/lm
LEDs/each optic 1
Light colour/type White
Required components:
 F15253_HEKLA-SOCKET-A

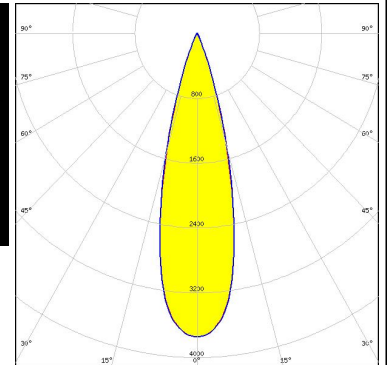

LED V9 HD Gen7
Ordering code CP18776_YASMEEN-70-M-C2-WHT
FWHM / FWTM 26.0° / 41.0°
Efficiency 89 %
Peak intensity 3.9 cd/lm
LEDs/each optic 1
Light colour/type White
Required components:
 F15859_HEKLA-SOCKET-I

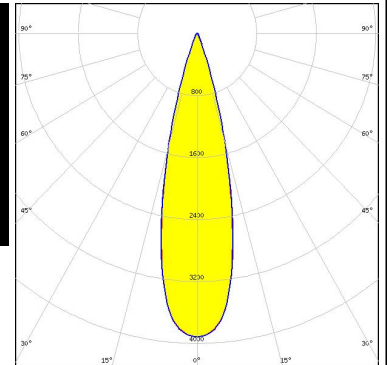

OPTICAL RESULTS (MEASURED):



LED V9 HD Gen7
Ordering code CP18762_YASMEEN-70-M-C2
FWHM / FWTM 26.0° / 42.0°
Efficiency 83 %
Peak intensity 3.9 cd/lm
LEDs/each optic 1
Light colour/type White
Required components:
 F15859_HEKLA-SOCKET-I

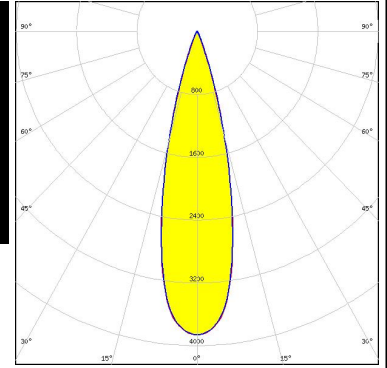
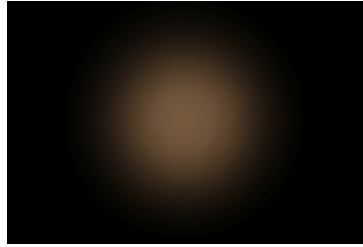

LED VERO10
Ordering code CP18762_YASMEEN-70-M-C2
FWHM / FWTM 26.0° / 42.5°
Efficiency 84 %
Peak intensity 3.9 cd/lm
LEDs/each optic 1
Light colour/type White
Required components:
 F15616_HEKLA-SOCKET-F

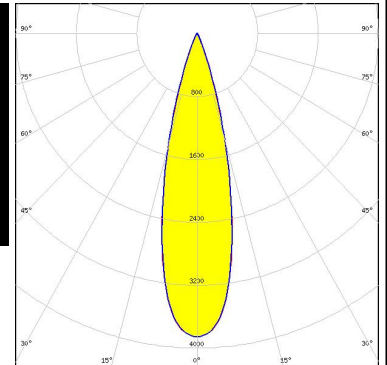

LED VERO10
Ordering code CP18776_YASMEEN-70-M-C2-WHT
FWHM / FWTM 26.0° / 42.0°
Efficiency 90 %
Peak intensity 3.9 cd/lm
LEDs/each optic 1
Light colour/type White
Required components:
 F15616_HEKLA-SOCKET-F

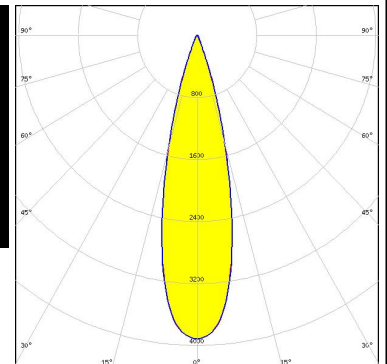

OPTICAL RESULTS (MEASURED):



LED Vesta DTW 13mm (21W)
Ordering code CP18762_YASMEEN-70-M-C2
FWHM / FWTM 25.0° / 46.0°
Efficiency 81 %
Peak intensity 3.7 cd/lm
LEDs/each optic 1
Light colour/type White
Required components:
 Bender Wirth: 632b Hekla XL

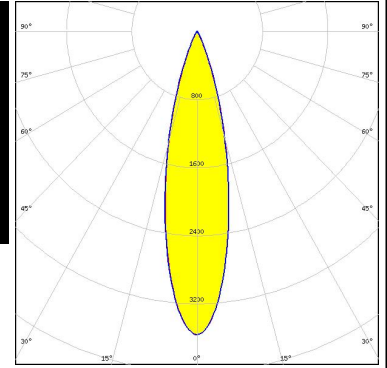

LED Vesta DTW 15mm (33W)
Ordering code CP18762_YASMEEN-70-M-C2
FWHM / FWTM 26.0° / 48.0°
Efficiency 81 %
Peak intensity 3.4 cd/lm
LEDs/each optic 1
Light colour/type White
Required components:
 Bender Wirth: 632b Hekla XL

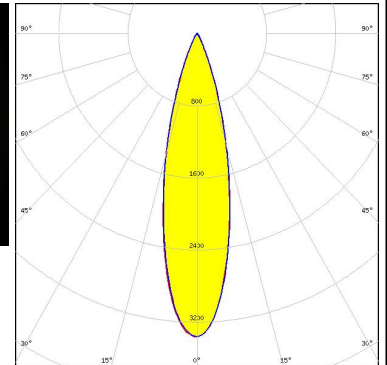

LED Vesta DTW 15mm (33W)
Ordering code CP18776_YASMEEN-70-M-C2-WHT
FWHM / FWTM 26.0° / 48.0°
Efficiency 89 %
Peak intensity 3.4 cd/lm
LEDs/each optic 1
Light colour/type White
Required components:
 Bender Wirth: 632b Hekla XL

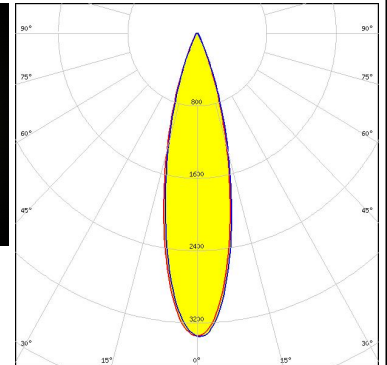
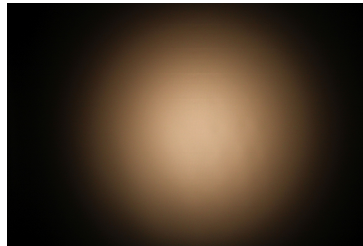

OPTICAL RESULTS (MEASURED):



LED Vesta DTW 9mm (4W/6W/12W)
Ordering code CP18762_YASMEEN-70-M-C2
FWHM / FWTM 27.0° / 43.0°
Efficiency 83 %
Peak intensity 3.9 cd/lm
LEDs/each optic 1
Light colour/type White
Required components:
Bender Wirth: 652b Hekla

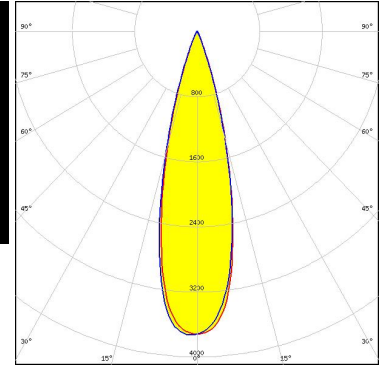

CITIZEN

LED CLL02x/CLU02x (LES10)
Ordering code CP18776_YASMEEN-70-M-C2-WHT
FWHM / FWTM 25.5° / 42.5°
Efficiency 89 %
Peak intensity 3.9 cd/lm
LEDs/each optic 1
Light colour/type White
Required components:
F17435_HEKLA-G2-C

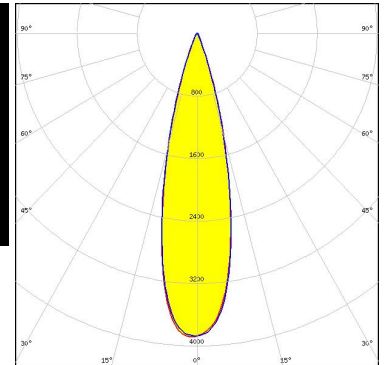

CITIZEN

LED CLL02x/CLU02x (LES10)
Ordering code CP18762_YASMEEN-70-M-C2
FWHM / FWTM 25.0° / 42.0°
Efficiency 83 %
Peak intensity 3.9 cd/lm
LEDs/each optic 1
Light colour/type White
Required components:
F17435_HEKLA-G2-C

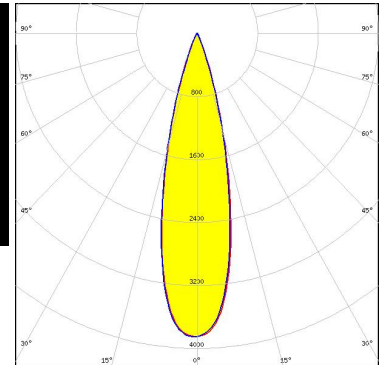
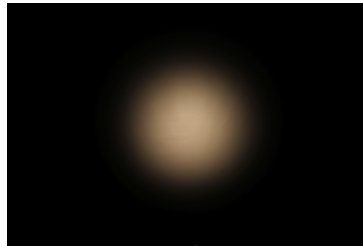

OPTICAL RESULTS (MEASURED):

CITIZEN

LED CLL03x/CLU03x
Ordering code CP18776_YASMEEN-70-M-C2-WHT
FWHM / FWTM 24.5° / 45.5°
Efficiency 89 %
Peak intensity 3.7 cd/lm
LEDs/each optic 1
Light colour/type White
Required components:
F17438_HEKLA-G2-I



CITIZEN

LED CLL03x/CLU03x
Ordering code CP18762_YASMEEN-70-M-C2
FWHM / FWTM 25.0° / 45.0°
Efficiency 82 %
Peak intensity 3.7 cd/lm
LEDs/each optic 1
Light colour/type White
Required components:
F17438_HEKLA-G2-I

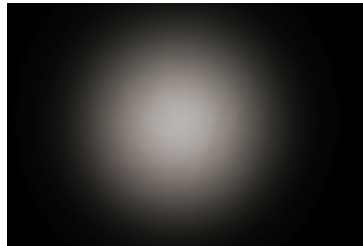

LED CMA1516
Ordering code CP18776_YASMEEN-70-M-C2-WHT
FWHM / FWTM 26.0° / 42.0°
Efficiency 90 %
Peak intensity 3.9 cd/lm
LEDs/each optic 1
Light colour/type White
Required components:
F17436_HEKLA-G2-D

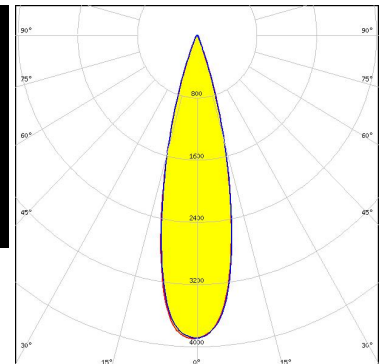
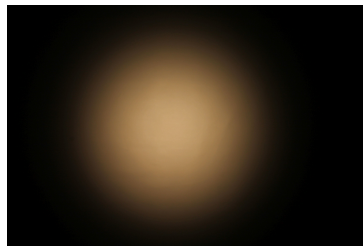

OPTICAL RESULTS (MEASURED):



LED CMA1516
Ordering code CP18762_YASMEEN-70-M-C2
FWHM / FWTM 26.0° / 42.0°
Efficiency 83 %
Peak intensity 3.9 cd/lm
LEDs/each optic 1
Light colour/type White
Required components:
 F17436_HEKLA-G2-D

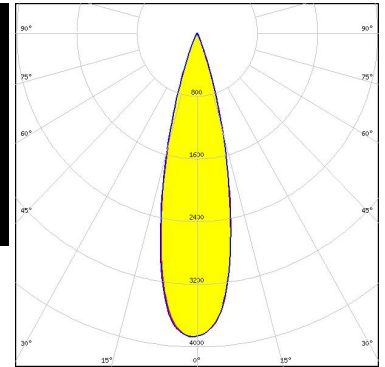

LED CMA1825
Ordering code CP18776_YASMEEN-70-M-C2-WHT
FWHM / FWTM 25.0° / 44.0°
Efficiency 90 %
Peak intensity 3.8 cd/lm
LEDs/each optic 1
Light colour/type White
Required components:
 F15254_HEKLA-SOCKET-B

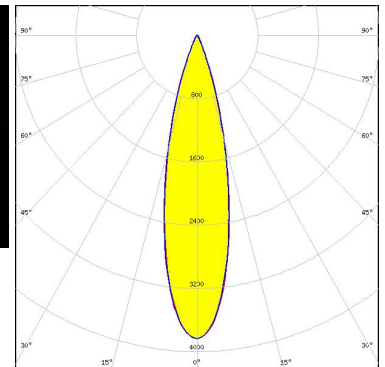
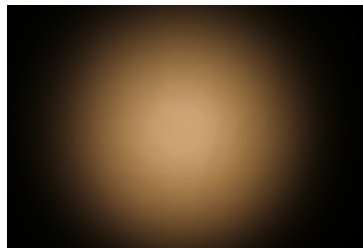

LED CMA1825
Ordering code CP18762_YASMEEN-70-M-C2
FWHM / FWTM 25.0° / 44.0°
Efficiency 83 %
Peak intensity 3.8 cd/lm
LEDs/each optic 1
Light colour/type White
Required components:
 F15254_HEKLA-SOCKET-B

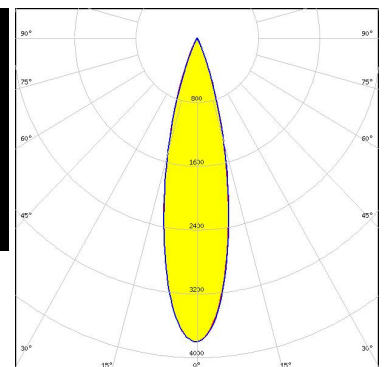
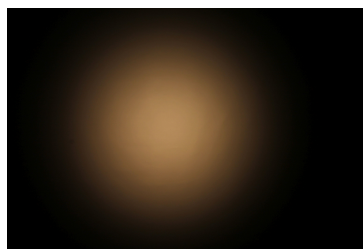

OPTICAL RESULTS (MEASURED):



LED CMT14xx
Ordering code CP18776_YASMEEN-70-M-C2-WHT
FWHM / FWTM 26.0° / 43.0°
Efficiency 90 %
Peak intensity 3.8 cd/lm
LEDs/each optic 1
Light colour/type White
Required components:
 F17435_HEKLA-G2-C

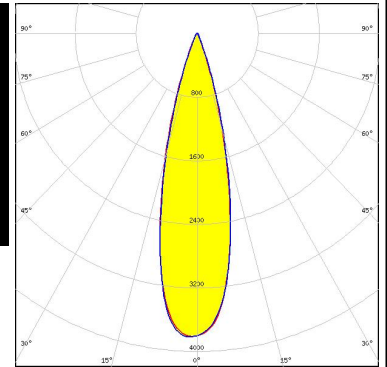

LED CMT14xx
Ordering code CP18762_YASMEEN-70-M-C2
FWHM / FWTM 26.0° / 42.0°
Efficiency 83 %
Peak intensity 3.8 cd/lm
LEDs/each optic 1
Light colour/type White
Required components:
 F17435_HEKLA-G2-C

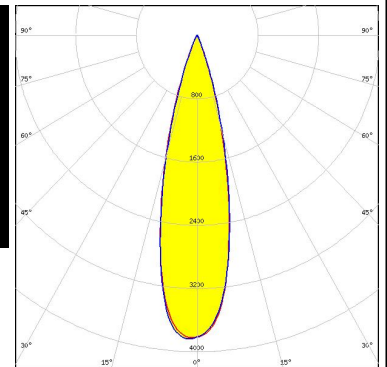
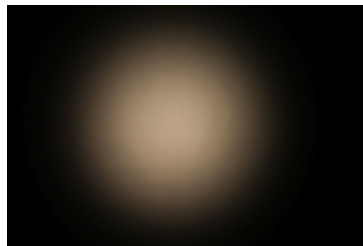

LED CMT19xx
Ordering code CP18776_YASMEEN-70-M-C2-WHT
FWHM / FWTM 25.0° / 46.0°
Efficiency 89 %
Peak intensity 3.7 cd/lm
LEDs/each optic 1
Light colour/type White
Required components:
 F17438_HEKLA-G2-I

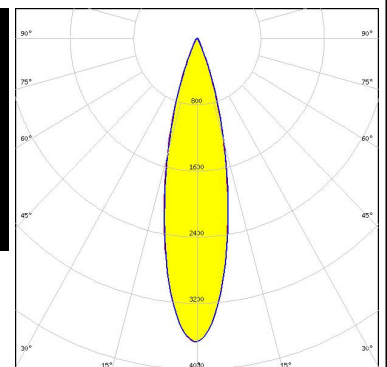
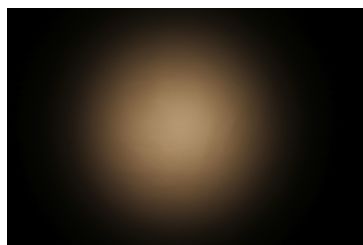

OPTICAL RESULTS (MEASURED):



LED CMT19xx
Ordering code CP18762_YASMEEN-70-M-C2
FWHM / FWTM 24.0° / 45.0°
Efficiency 81 %
Peak intensity 3.6 cd/lm
LEDs/each optic 1
Light colour/type White
Required components:
 F17438_HEKLA-G2-I

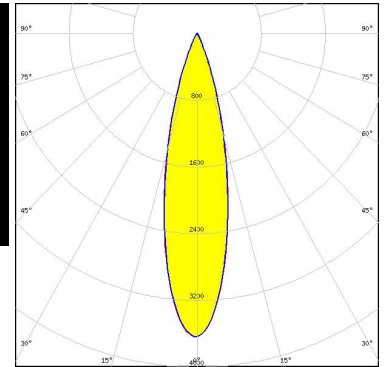
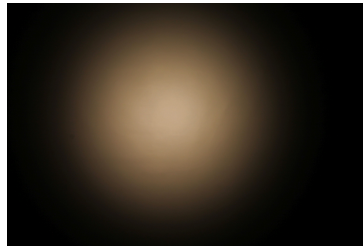

LED CMU15xx
Ordering code CP18762_YASMEEN-70-M-C2
FWHM / FWTM 26.0° / 47.0°
Efficiency 79 %
Peak intensity 3.3 cd/lm
LEDs/each optic 1
Light colour/type White
Required components:
 F17438_HEKLA-G2-I

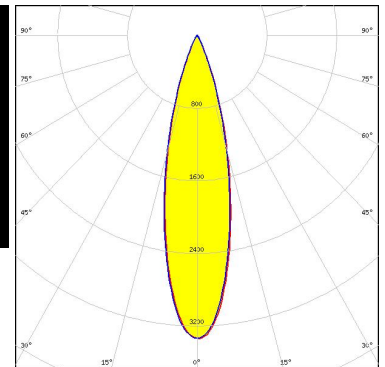

LED LUXEON CoB 1202/1203
Ordering code CP18762_YASMEEN-70-M-C2
FWHM / FWTM 26.0° / 42.0°
Efficiency 82 %
Peak intensity 3.9 cd/lm
LEDs/each optic 1
Light colour/type White
Required components:
 F17437_HEKLA-G2-H

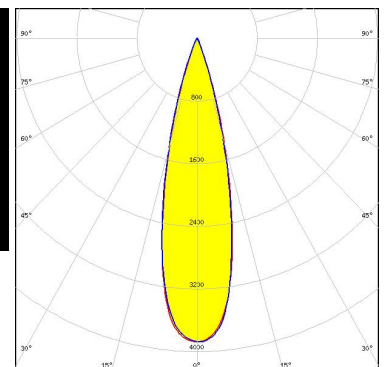
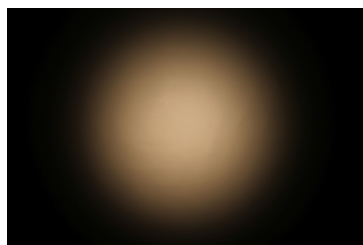

OPTICAL RESULTS (MEASURED):



LED LUXEON CoB 1202/1203
Ordering code CP18776_YASMEEN-70-M-C2-WHT
FWHM / FWTM 26.0° / 42.0°
Efficiency 90 %
Peak intensity 3.9 cd/lm
LEDs/each optic 1
Light colour/type White
Required components:
F17437_HEKLA-G2-H

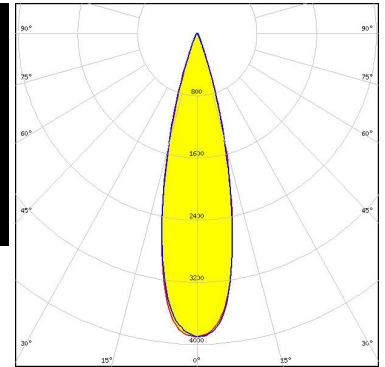

LED CTM-14 (Tunable White) Gen2
Ordering code CP18762_YASMEEN-70-M-C2
FWHM / FWTM 25.0° / 46.0°
Efficiency 81 %
Peak intensity 3.6 cd/lm
LEDs/each optic 1
Light colour/type Tunable White
Required components:
C16142_HEKLA-SOCKET-K
Bender Wirth: 442 Typ L8

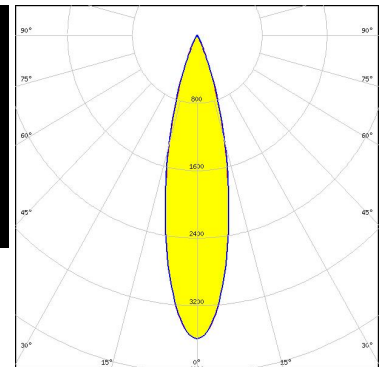
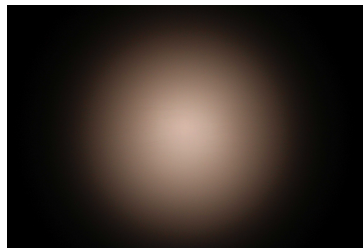

Light distribution files



LED COB L-Type (LES 11)
Ordering code CP18762_YASMEEN-70-M-C2
FWHM / FWTM 24.0° / 43.0°
Efficiency 82 %
Peak intensity 3.9 cd/lm
LEDs/each optic 1
Light colour/type White
Required components:
F17437_HEKLA-G2-H

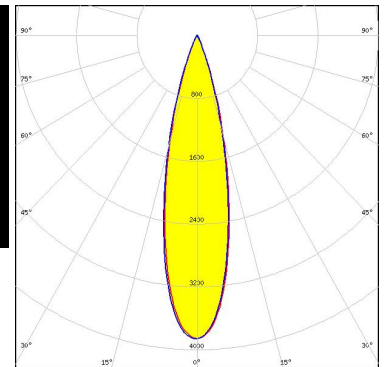
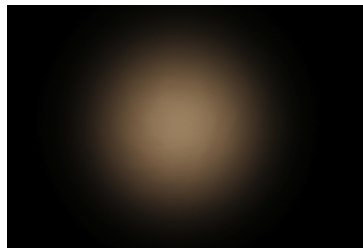

OPTICAL RESULTS (MEASURED):



LED COB L-Type (LES 9)
Ordering code CP18762_YASMEEN-70-M-C2
FWHM / FWTM 26.0° / 42.0°
Efficiency 82 %
Peak intensity 3.8 cd/lm
LEDs/each optic 1
Light colour/type White
Required components:
 F17437_HEKLA-G2-H

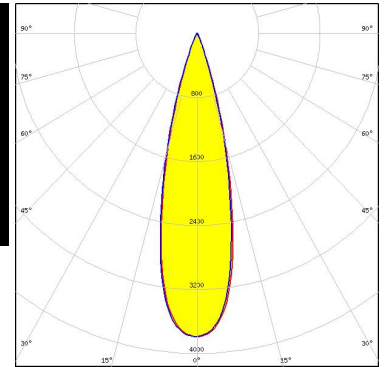
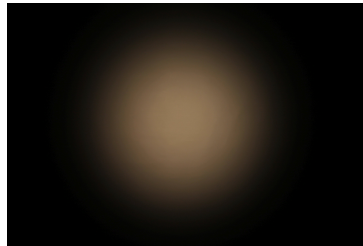

LED COB S-Type (LES 7)
Ordering code CP18776_YASMEEN-70-M-C2-WHT
FWHM / FWTM 24.0° / 44.0°
Efficiency 89 %
Peak intensity 3.8 cd/lm
LEDs/each optic 1
Light colour/type White
Required components:
 F17438_HEKLA-G2-I

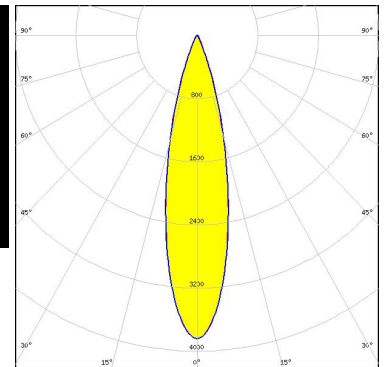
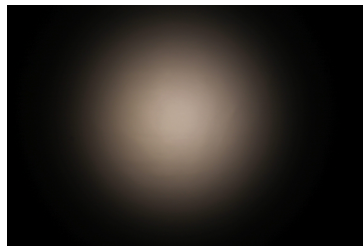

LED COB S-Type (LES 7)
Ordering code CP18762_YASMEEN-70-M-C2
FWHM / FWTM 24.0° / 45.0°
Efficiency 81 %
Peak intensity 3.8 cd/lm
LEDs/each optic 1
Light colour/type White
Required components:
 F17438_HEKLA-G2-I

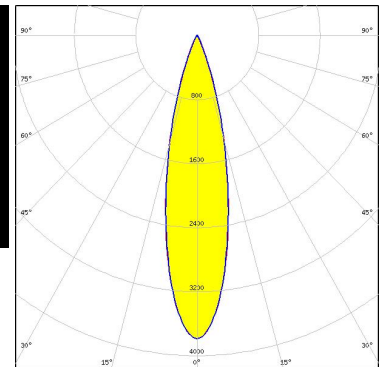
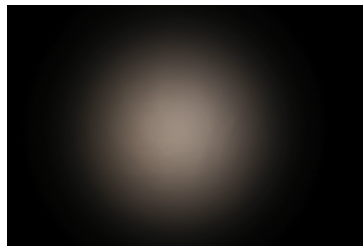

OPTICAL RESULTS (MEASURED):

PHILIPS

LED Fortimo SLM L09 CoB
 Ordering code CP18762_YASMEEN-70-M-C2
 FWHM / FWTM 25.0° / 42.0°
 Efficiency 82 %
 Peak intensity 3.9 cd/lm
 LEDs/each optic 1
 Light colour/type White
 Required components:
 F17437_HEKLA-G2-H

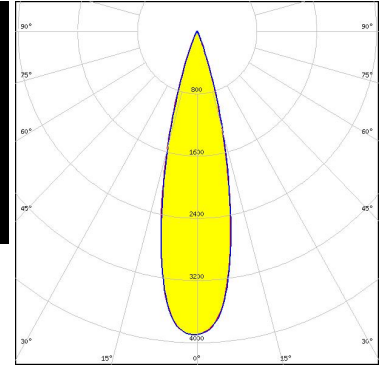

PHILIPS

LED Fortimo SLM L09 CoB
 Ordering code CP18776_YASMEEN-70-M-C2-WHT
 FWHM / FWTM 26.0° / 41.0°
 Efficiency 90 %
 Peak intensity 3.9 cd/lm
 LEDs/each optic 1
 Light colour/type White
 Required components:
 F17437_HEKLA-G2-H

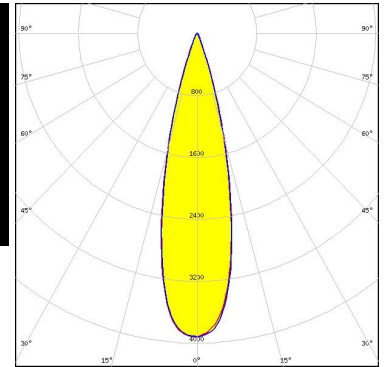

SAMSUNG

LED LC016D / LC019D / LC026D / LC033D
 Ordering code CP18776_YASMEEN-70-M-C2-WHT
 FWHM / FWTM 26.0° / 47.0°
 Efficiency 89 %
 Peak intensity 3.4 cd/lm
 LEDs/each optic 1
 Light colour/type White
 Required components:
 F17438_HEKLA-G2-I

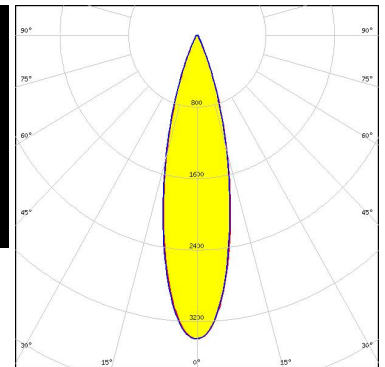
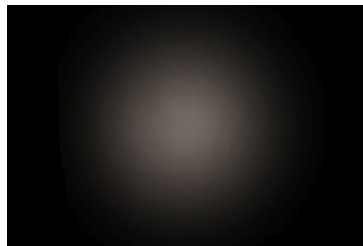

OPTICAL RESULTS (MEASURED):

SAMSUNG

LED LC016D / LC019D / LC026D / LC033D
Ordering code CP18762_YASMEEN-70-M-C2
FWHM / FWTM 26.0° / 47.0°
Efficiency 81 %
Peak intensity 3.4 cd/lm
LEDs/each optic 1
Light colour/type White
Required components:
F17438_HEKLA-G2-I

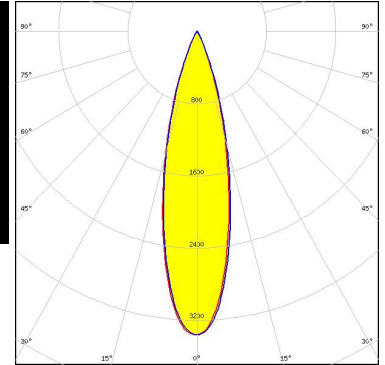

SAMSUNG

LED LC030C/040C G2
Ordering code CP18776_YASMEEN-70-M-C2-WHT
FWHM / FWTM 24.0° / 43.0°
Efficiency 90 %
Peak intensity 3.9 cd/lm
LEDs/each optic 1
Light colour/type White
Required components:
F17438_HEKLA-G2-I

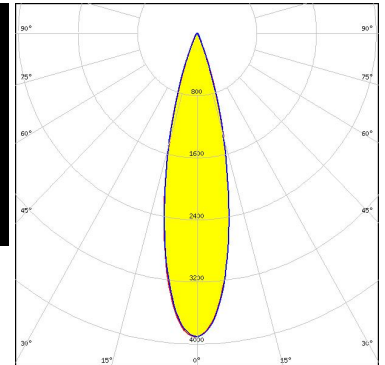
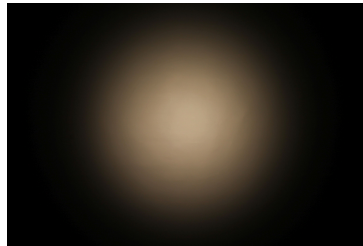

SAMSUNG

LED LC030C/040C G2
Ordering code CP18762_YASMEEN-70-M-C2
FWHM / FWTM 25.0° / 45.0°
Efficiency 82 %
Peak intensity 3.9 cd/lm
LEDs/each optic 1
Light colour/type White
Required components:
F17438_HEKLA-G2-I

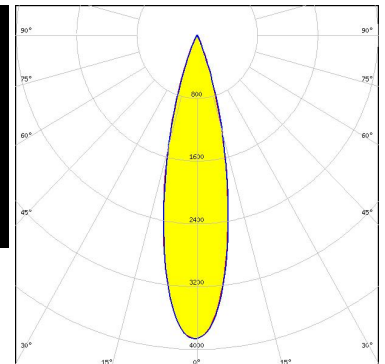
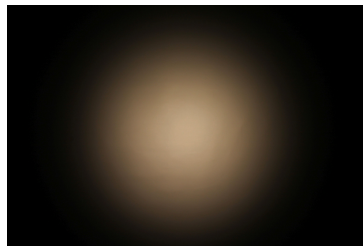

OPTICAL RESULTS (MEASURED):

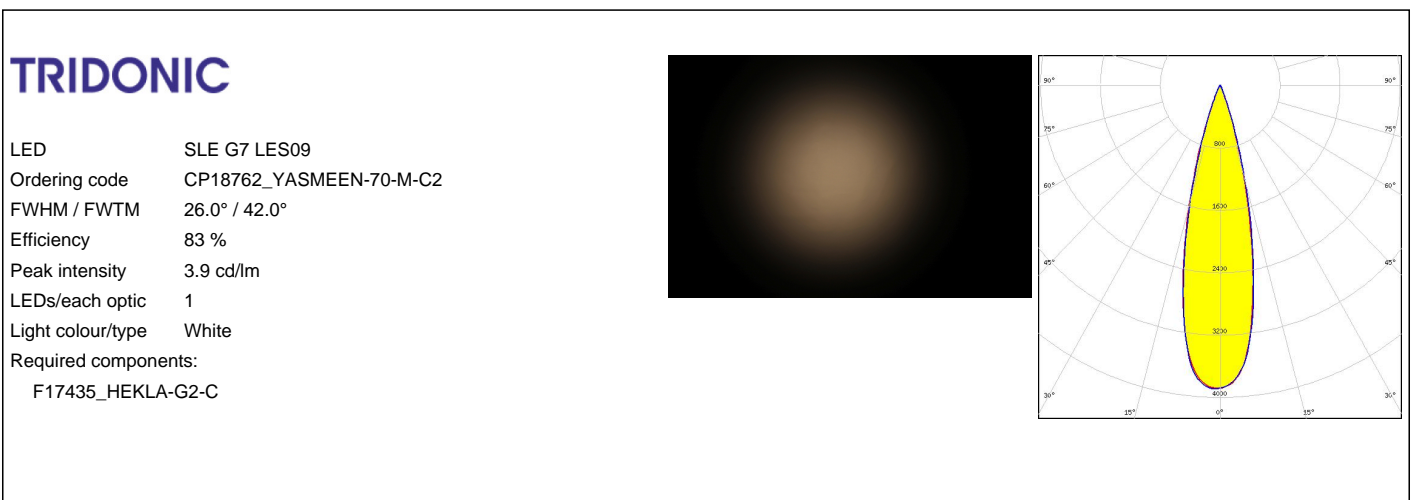
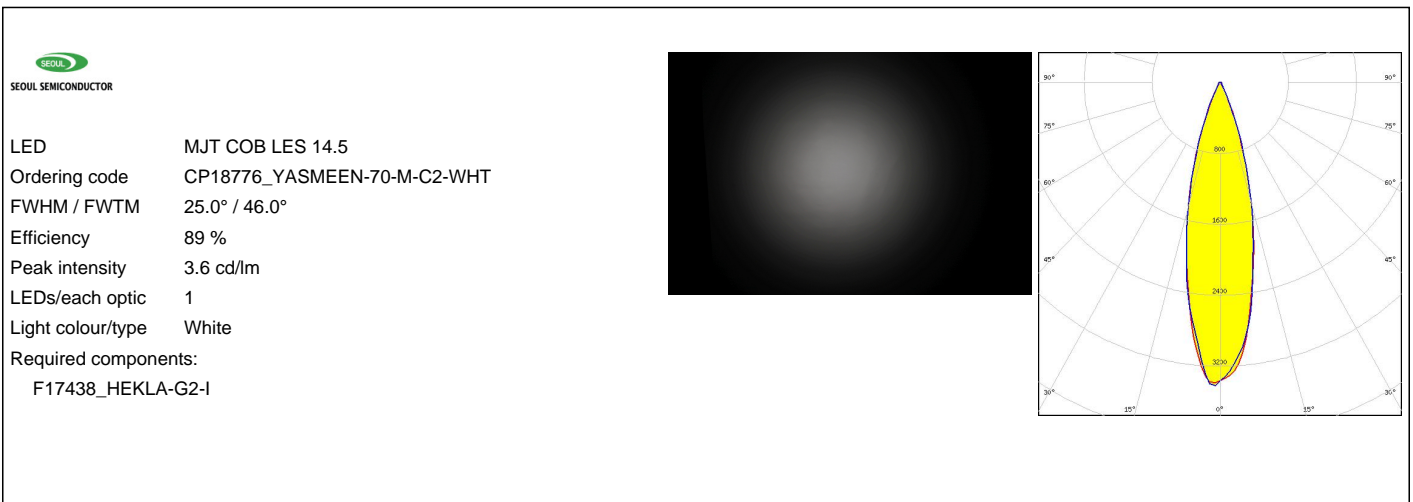
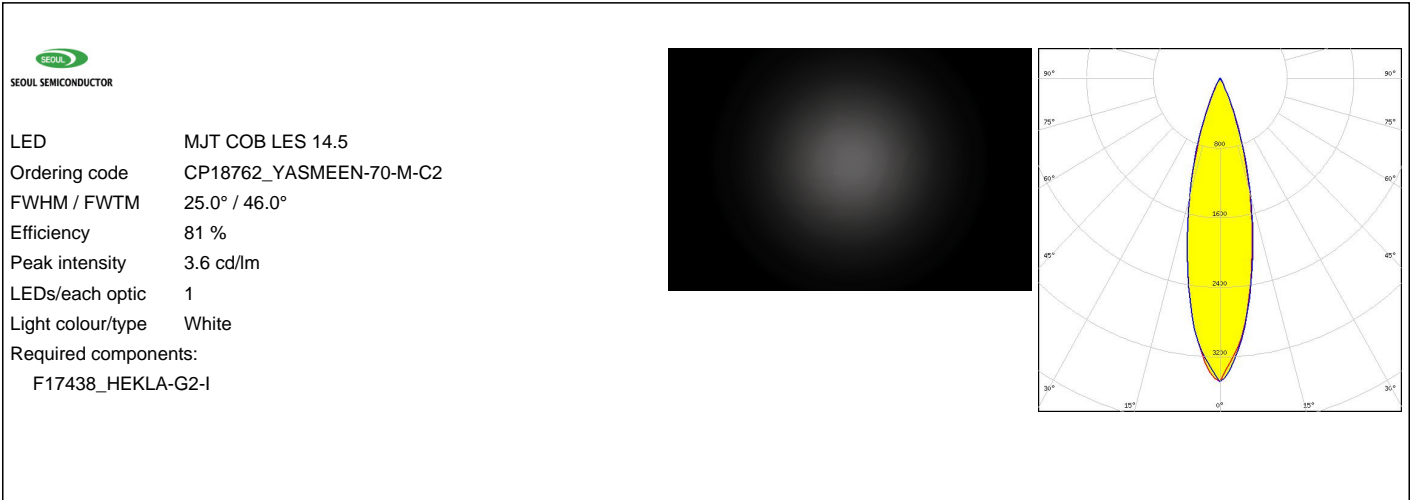

OPTICAL RESULTS (MEASURED):

TRIDONIC

LED SLE G7 LES15
Ordering code CP18762_YASMEEN-70-M-C2
FWHM / FWTM 25.0° / 46.0°
Efficiency 81 %
Peak intensity 3.6 cd/lm
LEDs/each optic 1
Light colour/type White
Required components:
F17438_HEKLA-G2-I

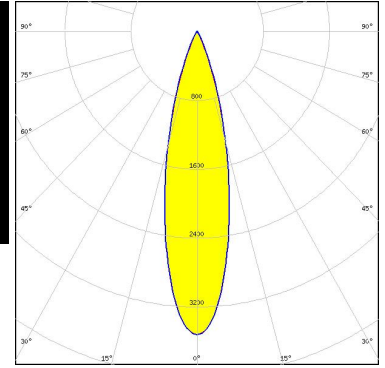

TRIDONIC

LED SLE G7 LES15
Ordering code CP18776_YASMEEN-70-M-C2-WHT
FWHM / FWTM 25.0° / 46.0°
Efficiency 90 %
Peak intensity 3.6 cd/lm
LEDs/each optic 1
Light colour/type White
Required components:
F17438_HEKLA-G2-I

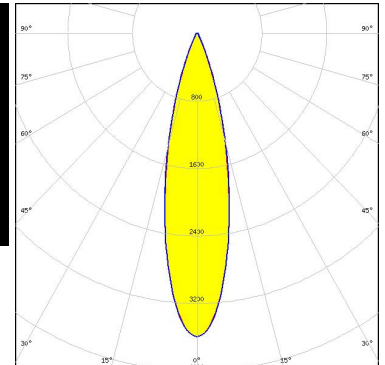
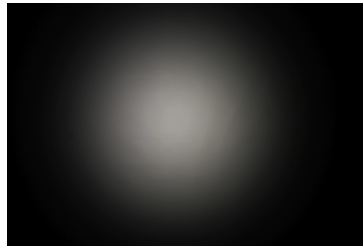

OPTICAL RESULTS (SIMULATED):



LED V13 Gen7
Ordering code CP18762_YASMEEN-70-M-C2
FWHM / FWTM 30.0° / 50.0°
Efficiency 86 %
Peak intensity 3.1 cd/lm
LEDs/each optic 1
Light colour/type White
Required components:

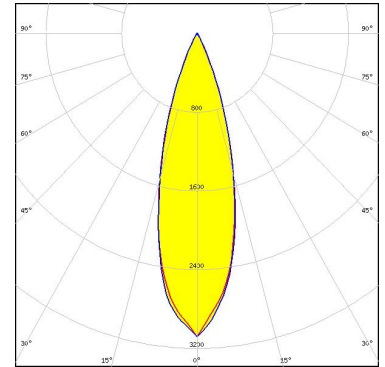

LED V3 HD Gen 8
Ordering code CP18762_YASMEEN-70-M-C2
FWHM / FWTM 28.0° / 40.0°
Efficiency 88 %
Peak intensity 4.4 cd/lm
LEDs/each optic 1
Light colour/type White
Required components:
F15253_HEKLA-SOCKET-A

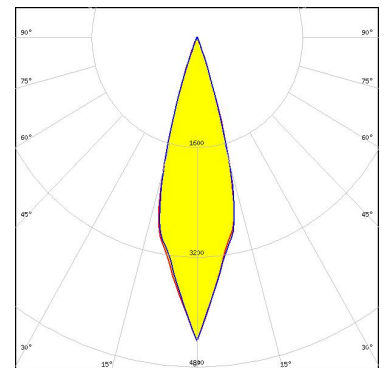



LED	V3 HD Gen 8 FC
Ordering code	CP18762_YASMEEN-70-M-C2
FWHM / FWTM	32.0° / 42.0°
Efficiency	87 %
Peak intensity	3.6 cd/lm
LEDs/each optic	1
Light colour/type	White
Required components:	
	F15255_HEKLA-SOCKET-C

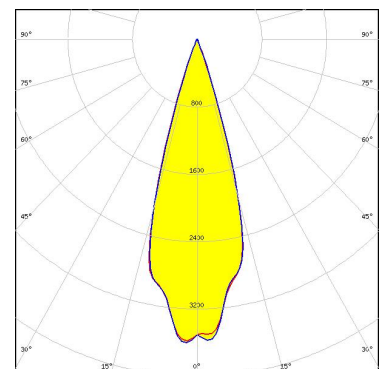

OPTICAL RESULTS (SIMULATED):



LED V4 HD Gen 8
Ordering code CP18762_YASMEEN-70-M-C2
FWHM / FWTM 28.0° / 40.0°
Efficiency 88 %
Peak intensity 4.4 cd/lm
LEDs/each optic 1
Light colour/type White
Required components:
 F15253_HEKLA-SOCKET-A

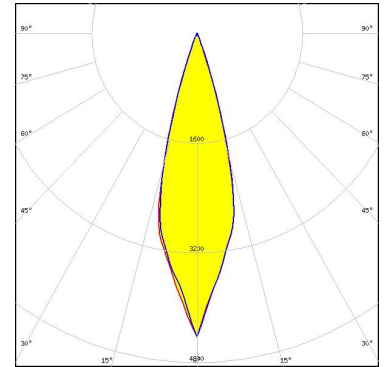

LED V6 Gen 8-9
Ordering code CP18762_YASMEEN-70-M-C2
FWHM / FWTM 28.0° / 42.0°
Efficiency 88 %
Peak intensity 4 cd/lm
LEDs/each optic 1
Light colour/type White
Required components:
 F15253_HEKLA-SOCKET-A

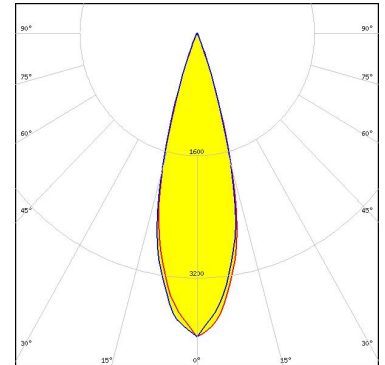

LED V6 HD Gen 7
Ordering code CP18762_YASMEEN-70-M-C2
FWHM / FWTM 30.0° / 42.0°
Efficiency 86 %
Peak intensity 3.7 cd/lm
LEDs/each optic 1
Light colour/type White
Required components:
 F15255_HEKLA-SOCKET-C

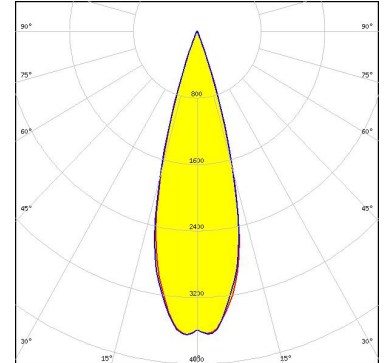

OPTICAL RESULTS (SIMULATED):



LED V6 HD Gen 8
Ordering code CP18762_YASMEEN-70-M-C2
FWHM / FWTM 30.0° / 42.0°
Efficiency 87 %
Peak intensity 3.7 cd/lm
LEDs/each optic 1
Light colour/type White
Required components:
F15255_HEKLA-SOCKET-C

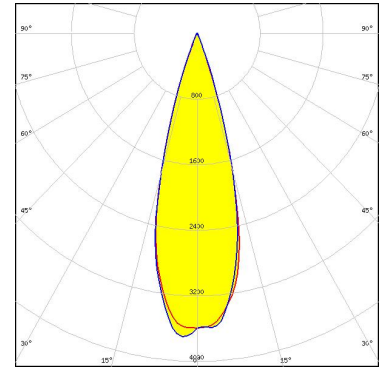

LED V8 Gen 8-9
Ordering code CP18762_YASMEEN-70-M-C2
FWHM / FWTM 28.0° / 42.0°
Efficiency 85 %
Peak intensity 3.8 cd/lm
LEDs/each optic 1
Light colour/type White
Required components:
F15253_HEKLA-SOCKET-A

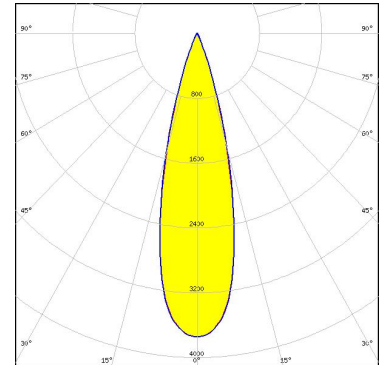

LED V9 HD Gen 8
Ordering code CP18762_YASMEEN-70-M-C2
FWHM / FWTM 28.0° / 44.0°
Efficiency 85 %
Peak intensity 3.7 cd/lm
LEDs/each optic 1
Light colour/type White
Required components:
F15859_HEKLA-SOCKET-I

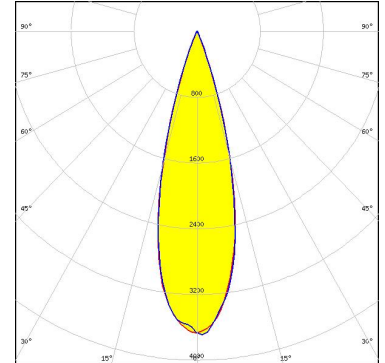

OPTICAL RESULTS (SIMULATED):



LED VERO13
Ordering code CP18762_YASMEEN-70-M-C2
FWHM / FWTM 28.0° / 48.0°
Efficiency 86 %
Peak intensity 3.4 cd/lm
LEDs/each optic 1
Light colour/type White
Required components:
 C16142_HEKLA-SOCKET-K

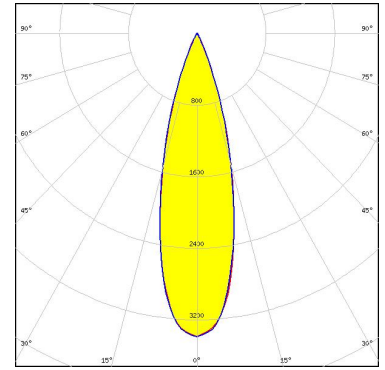

LED Vesta DTW 6mm
Ordering code CP18762_YASMEEN-70-M-C2
FWHM / FWTM 29.0° / 42.0°
Efficiency 86 %
Peak intensity 3.8 cd/lm
LEDs/each optic 1
Light colour/type White
Required components:

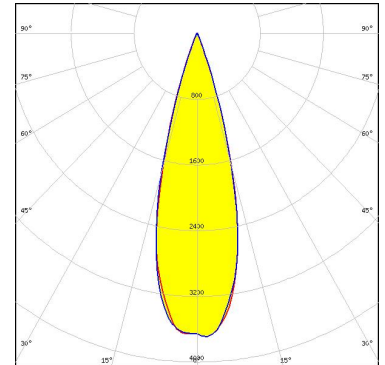

Bender Wirth: 652b Hekla



LED Vesta SE 13mm TW
Ordering code CP18762_YASMEEN-70-M-C2
FWHM / FWTM 24.0° / 42.0°
Efficiency 78 %
Peak intensity 4 cd/lm
LEDs/each optic 1
Light colour/type Tunable White
Required components:
 C16142_HEKLA-SOCKET-K

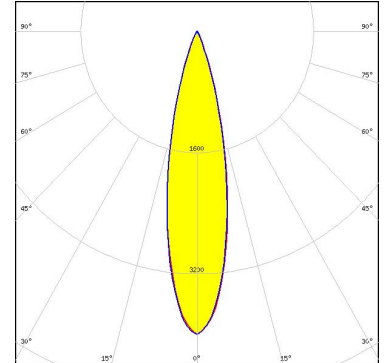

OPTICAL RESULTS (SIMULATED):



LED Vesta TW 13mm (18W) DP
Ordering code CP18762_YASMEEN-70-M-C2
FWHM / FWTM 24.0° / 44.0°
Efficiency 82 %
Peak intensity 4 cd/lm
LEDs/each optic 1
Light colour/type Tunable White
Required components:
C16142_HEKLA-SOCKET-K

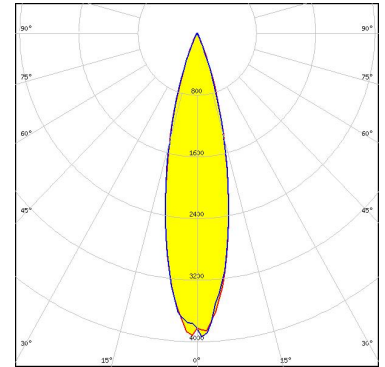

Bender Wirth: 492 Typ L8



LED Vesta TW 15mm DP
Ordering code CP18762_YASMEEN-70-M-C2
FWHM / FWTM 26.0° / 46.0°
Efficiency 81 %
Peak intensity 3.6 cd/lm
LEDs/each optic 1
Light colour/type Tunable White
Required components:
C16142_HEKLA-SOCKET-K

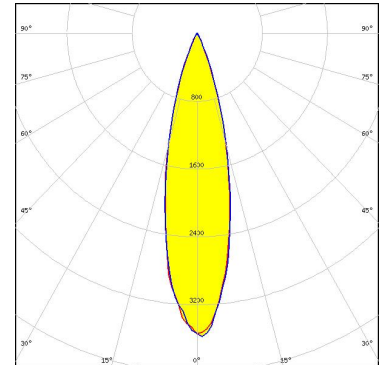

Bender Wirth: 482 Typ L8



LED Vesta TW 9mm (9W) DP
Ordering code CP18762_YASMEEN-70-M-C2
FWHM / FWTM 33.0° / 49.0°
Efficiency 87 %
Peak intensity 3.1 cd/lm
LEDs/each optic 1
Light colour/type Tunable White
Required components:
C16142_HEKLA-SOCKET-K

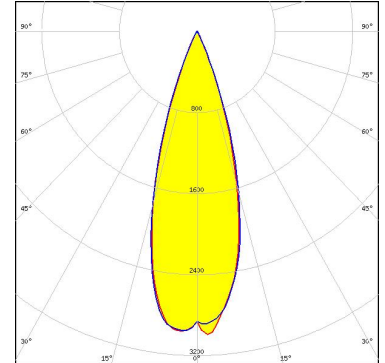

Bender Wirth: 489 Typ L8

OPTICAL RESULTS (SIMULATED):

CITIZEN

LED	CLL03x/CLU03x
Ordering code	CP18769_YASMEEN-70-M-B2
FWHM / FWTM	26.0° / 46.0°
Efficiency	83 %
Peak intensity	3.5 cd/lm
LEDs/each optic	1
Light colour/type	White
Required components:	

BJB: 47.360.1010

Light distribution files

CITIZEN

LED	CLU03Q Type-F
Ordering code	CP18762_YASMEEN-70-M-C2
FWHM / FWTM	28.0° / 50.0°
Efficiency	82 %
Peak intensity	3.1 cd/lm
LEDs/each optic	1
Light colour/type	White
Required components:	F17438_HEKLA-G2-I

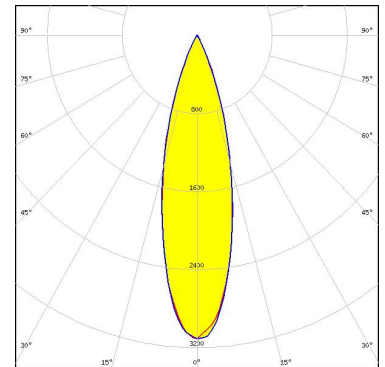

CITIZEN

LED	CLU712/713
Ordering code	CP18762_YASMEEN-70-M-C2
FWHM / FWTM	28.0° / 42.0°
Efficiency	84 %
Peak intensity	3.8 cd/lm
LEDs/each optic	1
Light colour/type	White
Required components:	F17438_HEKLA-G2-I

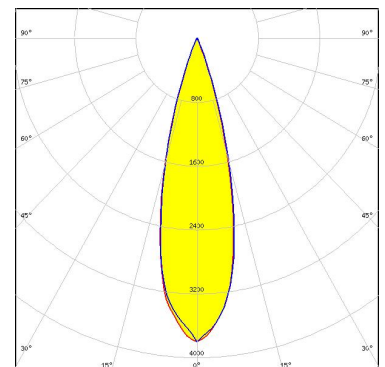

OPTICAL RESULTS (SIMULATED):



LED: CHA0304
Ordering code: CP18762_YASMEEN-70-M-C2
FWHM / FWTM: 30.0° / 41.0°
Efficiency: 85 %
Peak intensity: 3.8 cd/lm
LEDs/each optic: 1
Light colour/type: White
Required components:
F17435_HEKLA-G2-C

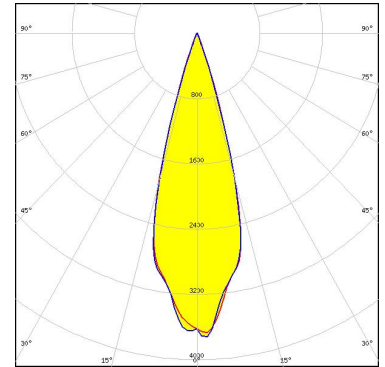

LED: CHA0410
Ordering code: CP18762_YASMEEN-70-M-C2
FWHM / FWTM: 30.0° / 41.0°
Efficiency: 85 %
Peak intensity: 3.9 cd/lm
LEDs/each optic: 1
Light colour/type: White
Required components:
F17435_HEKLA-G2-C

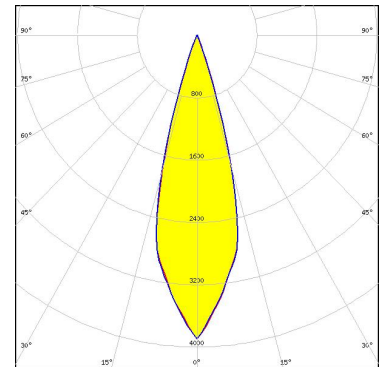

LED: CHA0612
Ordering code: CP18762_YASMEEN-70-M-C2
FWHM / FWTM: 30.0° / 42.0°
Efficiency: 85 %
Peak intensity: 3.7 cd/lm
LEDs/each optic: 1
Light colour/type: White
Required components:
F17435_HEKLA-G2-C

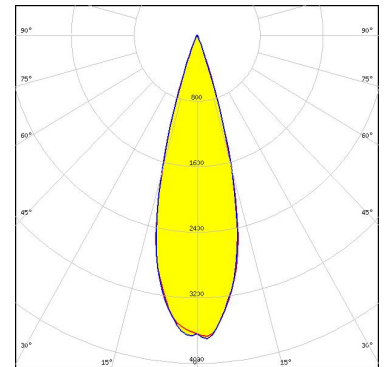

OPTICAL RESULTS (SIMULATED):



LED CMU10xx
Ordering code CP18762_YASMEEN-70-M-C2
FWHM / FWTM 27.0° / 44.0°
Efficiency 85 %
Peak intensity 3.9 cd/lm
LEDs/each optic 1
Light colour/type White
Required components:
F17435_HEKLA-G2-C

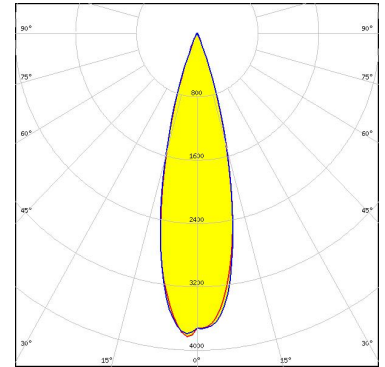

LED CMU15xx
Ordering code CP18762_YASMEEN-70-M-C2
FWHM / FWTM 26.0° / 46.0°
Efficiency 83 %
Peak intensity 3.6 cd/lm
LEDs/each optic 1
Light colour/type White
Required components:
F17438_HEKLA-G2-I

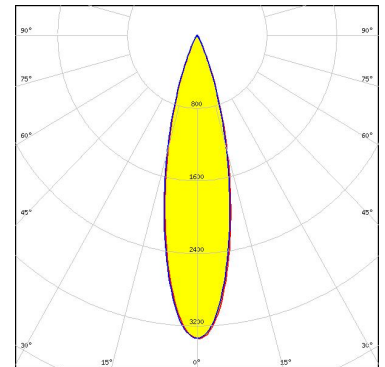

LED CXA/B 13xx
Ordering code CP18762_YASMEEN-70-M-C2
FWHM / FWTM 30.0° / 43.0°
Efficiency 85 %
Peak intensity 3.6 cd/lm
LEDs/each optic 1
Light colour/type White
Required components:
F17439_HEKLA-G2-J

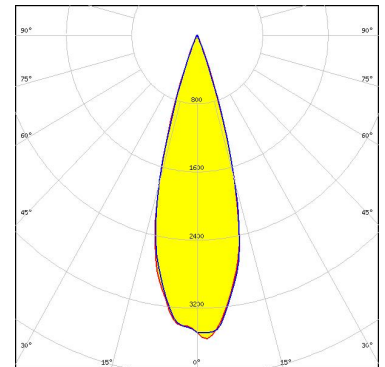

OPTICAL RESULTS (SIMULATED):



LED CXA/B 15xx
Ordering code CP18762_YASMEEN-70-M-C2
FWHM / FWTM 28.0° / 42.0°
Efficiency 84 %
Peak intensity 3.8 cd/lm
LEDs/each optic 1
Light colour/type White
Required components:
F17436_HEKLA-G2-D

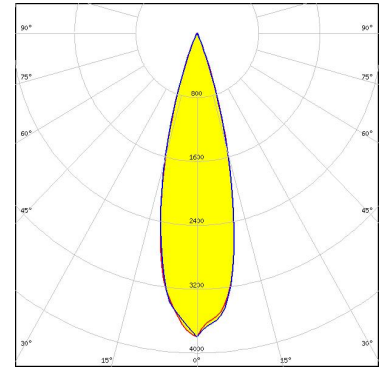

LED CXA/B 1830
Ordering code CP18762_YASMEEN-70-M-C2
FWHM / FWTM 26.0° / 46.0°
Efficiency 83 %
Peak intensity 3.6 cd/lm
LEDs/each optic 1
Light colour/type White
Required components:

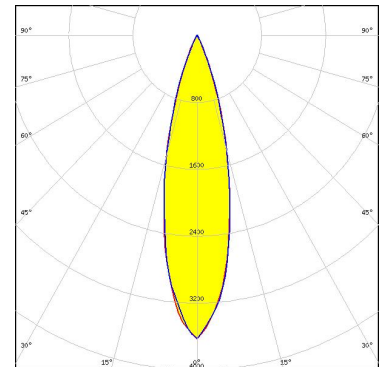

Bender Wirth: 637b Hekla



LED LUXEON CX Plus CoB L08 (Gen2)
Ordering code CP18762_YASMEEN-70-M-C2
FWHM / FWTM 26.0° / 48.0°
Efficiency 83 %
Peak intensity 3.6 cd/lm
LEDs/each optic 1
Light colour/type White
Required components:

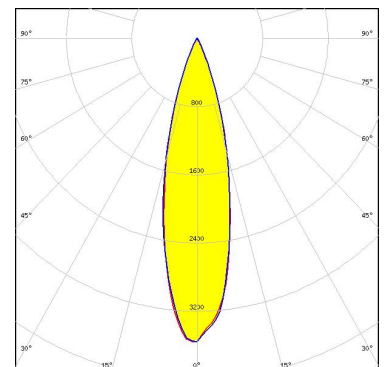

Bender Wirth: 637a Hekla

OPTICAL RESULTS (SIMULATED):



LED LUXEON CoB 1202/1203
Ordering code CP18762_YASMEEN-70-M-C2
FWHM / FWTM 26.0° / 42.0°
Efficiency 85 %
Peak intensity 4 cd/lm
LEDs/each optic 1
Light colour/type White
Required components:
F15858_HEKLA-SOCKET-H

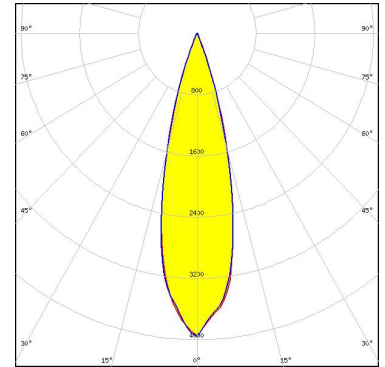

LED LUXEON CoB 1202HD
Ordering code CP18762_YASMEEN-70-M-C2
FWHM / FWTM 28.0° / 42.0°
Efficiency 87 %
Peak intensity 4 cd/lm
LEDs/each optic 1
Light colour/type White
Required components:
F15848_HEKLA-SOCKET-G

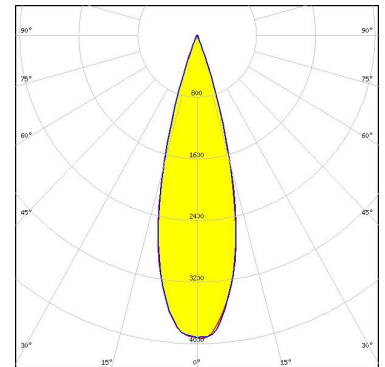

LED LUXEON CoB 1204/1205
Ordering code CP18762_YASMEEN-70-M-C2
FWHM / FWTM 26.0° / 46.0°
Efficiency 84 %
Peak intensity 3.8 cd/lm
LEDs/each optic 1
Light colour/type White
Required components:

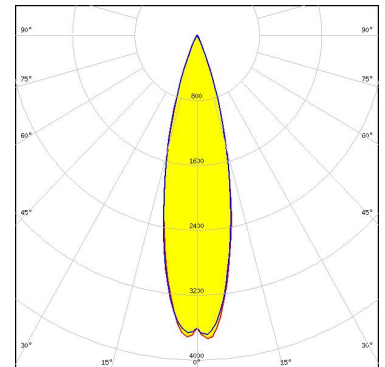

Bender Wirth: 632a Hekla XL

OPTICAL RESULTS (SIMULATED):



LED LUXEON CoB 1204HD
Ordering code CP18762_YASMEEN-70-M-C2
FWHM / FWTM 28.0° / 44.0°
Efficiency 85 %
Peak intensity 3.8 cd/lm
LEDs/each optic 1
Light colour/type White
Required components:
F15858_HEKLA-SOCKET-H

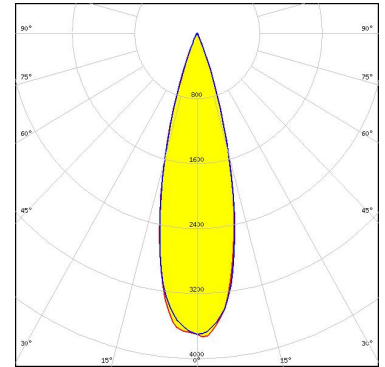

LED LUXEON CoB 1205HD
Ordering code CP18762_YASMEEN-70-M-C2
FWHM / FWTM 26.0° / 44.0°
Efficiency 84 %
Peak intensity 4 cd/lm
LEDs/each optic 1
Light colour/type White
Required components:
F15858_HEKLA-SOCKET-H

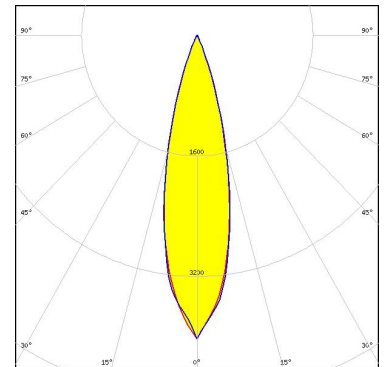

LED LUXEON CoB 1208
Ordering code CP18762_YASMEEN-70-M-C2
FWHM / FWTM 26.0° / 46.0°
Efficiency 83 %
Peak intensity 3.6 cd/lm
LEDs/each optic 1
Light colour/type White
Required components:

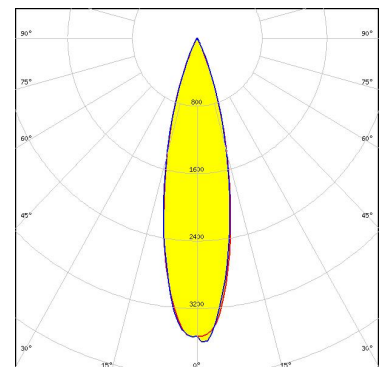

Bender Wirth: 632a Hekla XL

OPTICAL RESULTS (SIMULATED):



LED LUXEON CX Plus CoB - HD S02H6
Ordering code CP18769_YASMEEN-70-M-B2
FWHM / FWTM 30.0° / 44.0°
Efficiency 87 %
Peak intensity 3.6 cd/lm
LEDs/each optic 1
Light colour/type White
Required components:

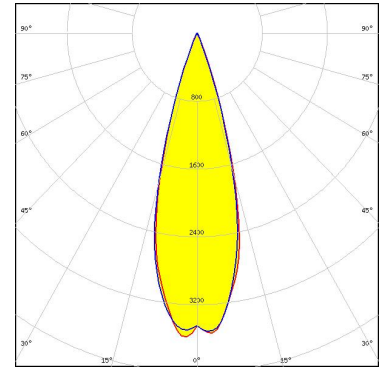

Bender Wirth: 634c Bayonet35L



LED LUXEON CX Plus CoB - HD S04H9
Ordering code CP18769_YASMEEN-70-M-B2
FWHM / FWTM 28.0° / 46.0°
Efficiency 86 %
Peak intensity 3.6 cd/lm
LEDs/each optic 1
Light colour/type White
Required components:

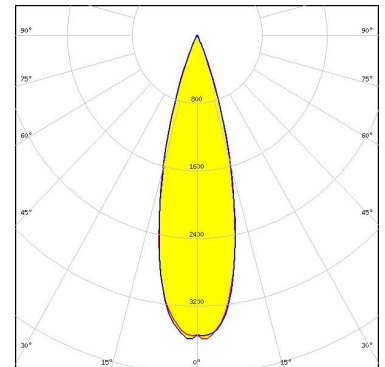

Bender Wirth: 634a Bayonet35L



LED LUXEON CX Plus CoB L04 / L05 (Gen2)
Ordering code CP18762_YASMEEN-70-M-C2
FWHM / FWTM 26.0° / 44.0°
Efficiency 83 %
Peak intensity 3.9 cd/lm
LEDs/each optic 1
Light colour/type White
Required components:
 F15254_HEKLA-SOCKET-B

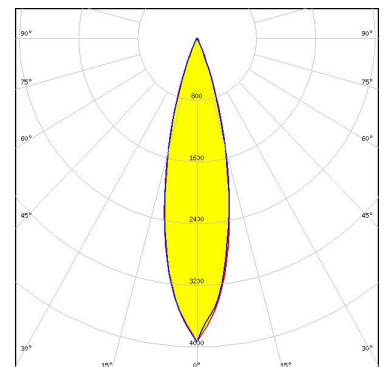

OPTICAL RESULTS (SIMULATED):



LED LUXEON CX Plus CoB M02 / M03 (Gen2)
Ordering code CP18762_YASMEEN-70-M-C2
FWHM / FWTM 27.0° / 44.0°
Efficiency 86 %
Peak intensity 4 cd/lm
LEDs/each optic 1
Light colour/type White
Required components:
 F15256_HEKLA-SOCKET-D

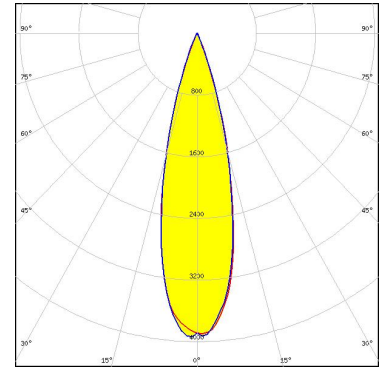

LED LUXEON CX Plus CoB S01 (Gen2)
Ordering code CP18762_YASMEEN-70-M-C2
FWHM / FWTM 28.0° / 42.0°
Efficiency 88 %
Peak intensity 4 cd/lm
LEDs/each optic 1
Light colour/type White
Required components:
 F15956_HEKLA-SOCKET-J

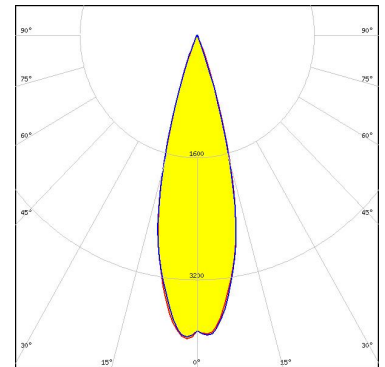

LED CHM-9 XH (19x19)
Ordering code CP18762_YASMEEN-70-M-C2
FWHM / FWTM 28.0° / 42.0°
Efficiency 84 %
Peak intensity 3.9 cd/lm
LEDs/each optic 1
Light colour/type White
Required components:
 F15859_HEKLA-SOCKET-I

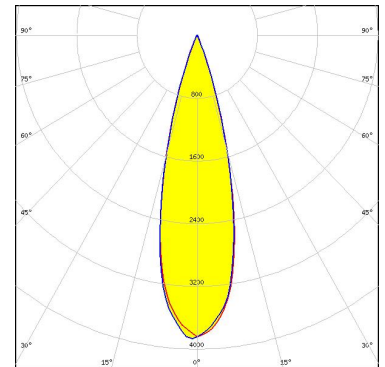

OPTICAL RESULTS (SIMULATED):



LED CTM-6 (Tunable White) Gen2
Ordering code CP18762_YASMEEN-70-M-C2
FWHM / FWTM 28.0° / 42.0°
Efficiency 84 %
Peak intensity 3.8 cd/lm
LEDs/each optic 1
Light colour/type Tunable White
Required components:
C16142_HEKLA-SOCKET-K

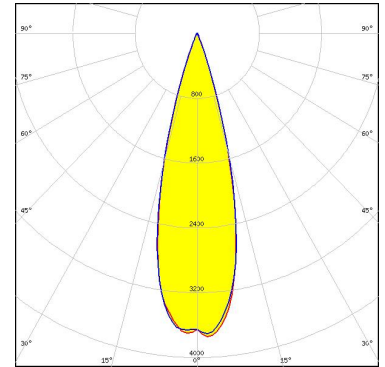

Bender Wirth: 495 Typ L8



LED CTM-9 (Tunable White) Gen2
FWHM / FWTM 28.0° / 44.0°
Efficiency 82 %
Peak intensity 3.6 cd/lm
LEDs/each optic 1
Light colour/type Tunable White
Required components:
C16142_HEKLA-SOCKET-K

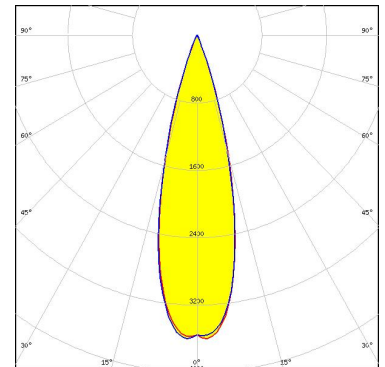

Bender Wirth: 495 Typ L8



LED CXM-3
Ordering code CP18769_YASMEEN-70-M-B2
FWHM / FWTM 30.0° / 40.0°
Efficiency 87 %
Peak intensity 3.9 cd/lm
LEDs/each optic 1
Light colour/type White
Required components:

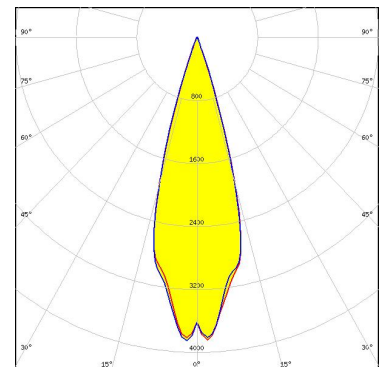

Bender Wirth: 634a Bayonet35L

OPTICAL RESULTS (SIMULATED):



LED CXM-4
Ordering code CP18769_YASMEEN-70-M-B2
FWHM / FWTM 28.0° / 41.0°
Efficiency 87 %
Peak intensity 4 cd/lm
LEDs/each optic 1
Light colour/type White
Required components:

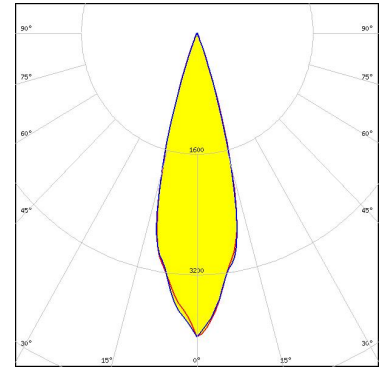

Bender Wirth: 634a Bayonet35L



LED CxM-6 (13.5x13.5)
Ordering code CP18769_YASMEEN-70-M-B2
FWHM / FWTM 28.0° / 40.0°
Efficiency 86 %
Peak intensity 4.3 cd/lm
LEDs/each optic 1
Light colour/type White
Required components:

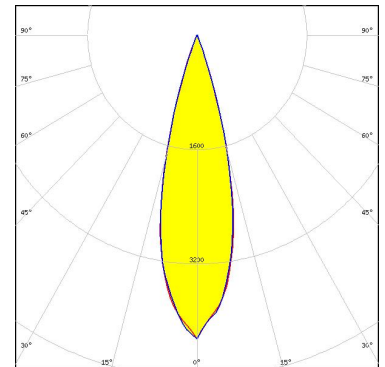

BJB: 47.360.1020



LED CxM-9 (13.5x13.5)
Ordering code CP18762_YASMEEN-70-M-C2
FWHM / FWTM 26.0° / 44.0°
Efficiency 85 %
Peak intensity 4 cd/lm
LEDs/each optic 1
Light colour/type White
Required components:
F17435_HEKLA-G2-C

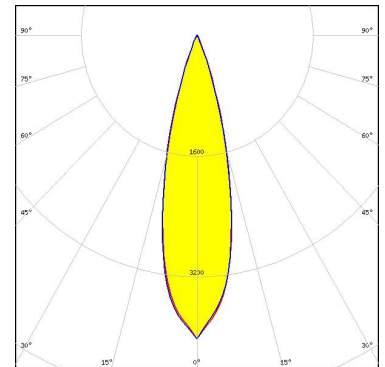

OPTICAL RESULTS (SIMULATED):

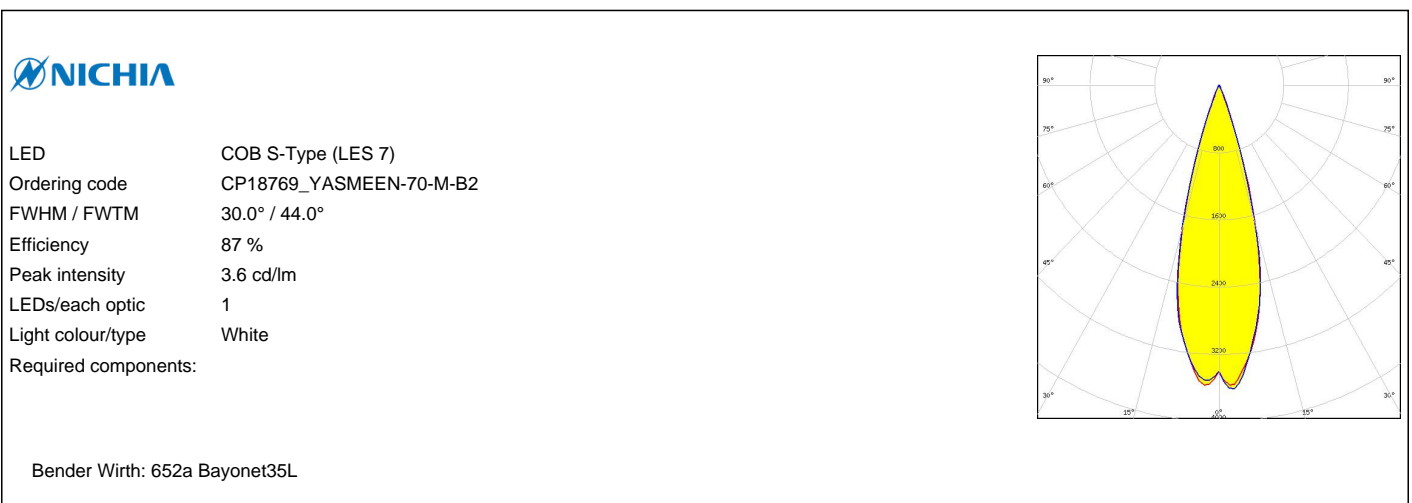
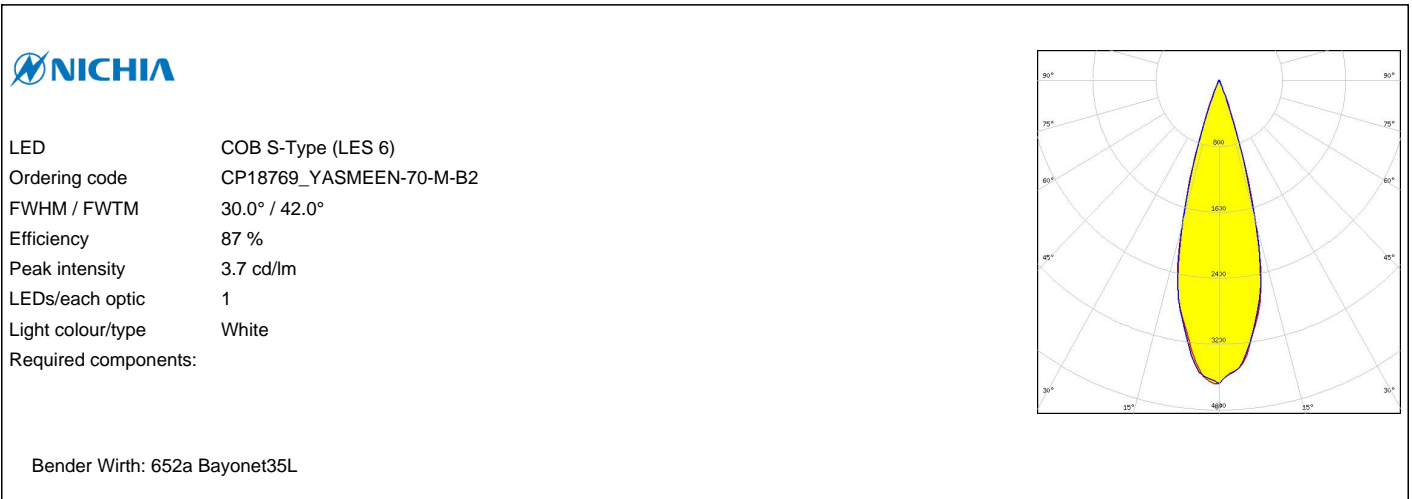

OPTICAL RESULTS (SIMULATED):



LED NJCWL024Z-V1MT: COB L-Type Tunable White
Ordering code CP18762_YASMEEN-70-M-C2
FWHM / FWTM 26.0° / 41.0°
Efficiency 83 %
Peak intensity 4 cd/lm
LEDs/each optic 1
Light colour/type Tunable White
Required components:
 C16142_HEKLA-SOCKET-K

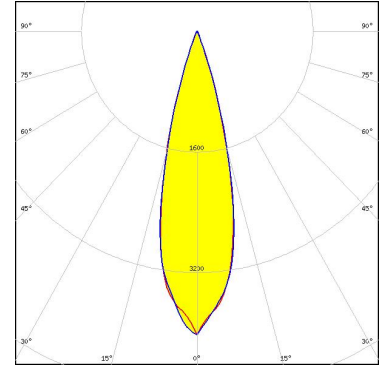

Bender Wirth: 497 Typ L8 HV



LED NJCWL024Z-V1MT: COB L-Type Tunable White
Ordering code CP18762_YASMEEN-70-M-C2
FWHM / FWTM 26.0° / 41.0°
Efficiency 83 %
Peak intensity 4 cd/lm
LEDs/each optic 1
Light colour/type Tunable White
Required components:
 C16142_HEKLA-SOCKET-K

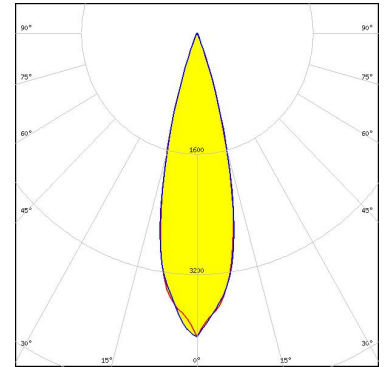

Bender Wirth: 497 Typ L8 HV



LED NJNWS012Z-V1MT: COB S-Type Tunable White
Ordering code CP18762_YASMEEN-70-M-C2
FWHM / FWTM 28.0° / 40.0°
Efficiency 84 %
Peak intensity 3.9 cd/lm
LEDs/each optic 1
Light colour/type Tunable White
Required components:
 C16142_HEKLA-SOCKET-K

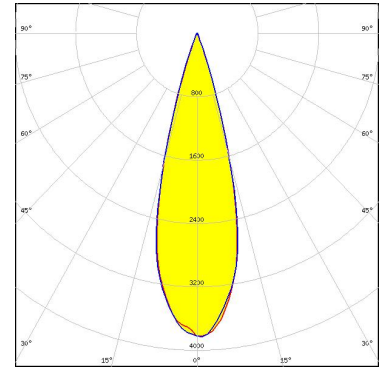

Bender Wirth: 495 Typ L8 HV

OPTICAL RESULTS (SIMULATED):

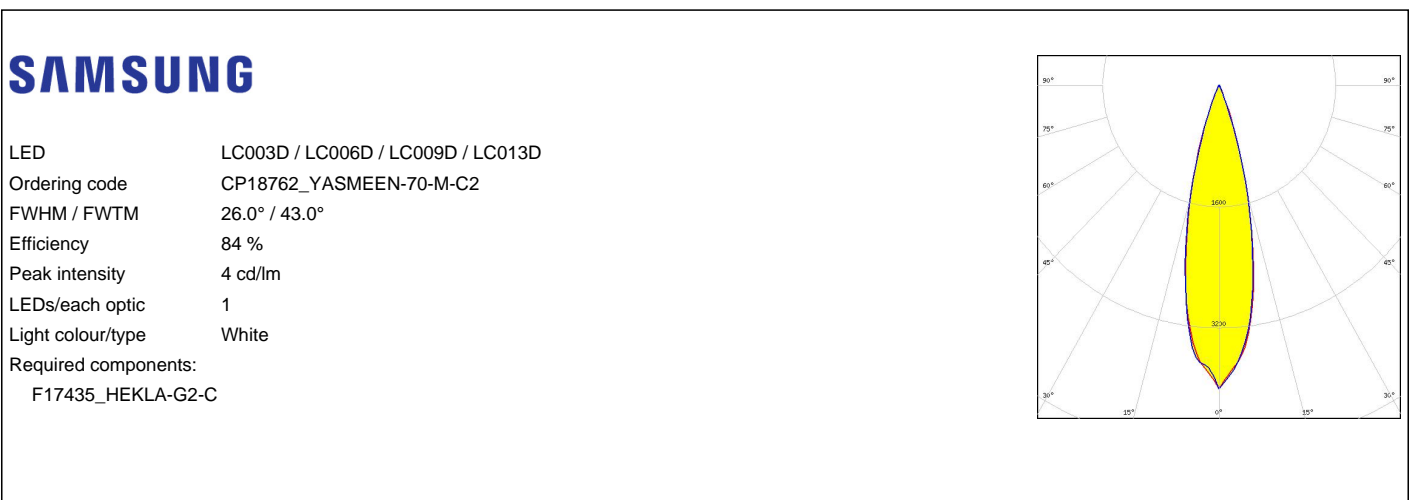
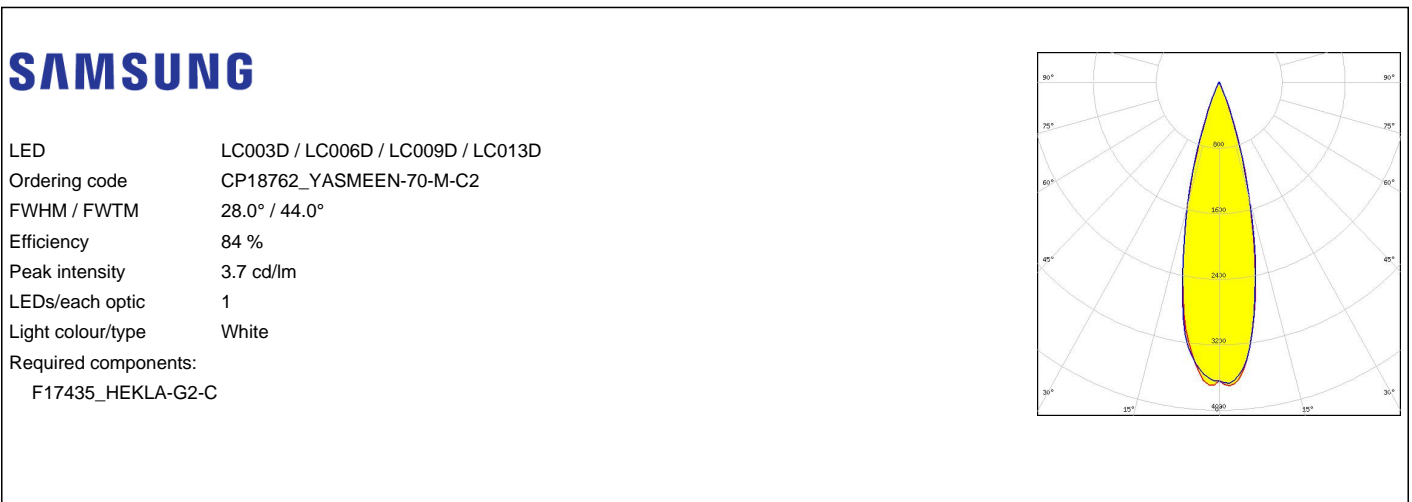
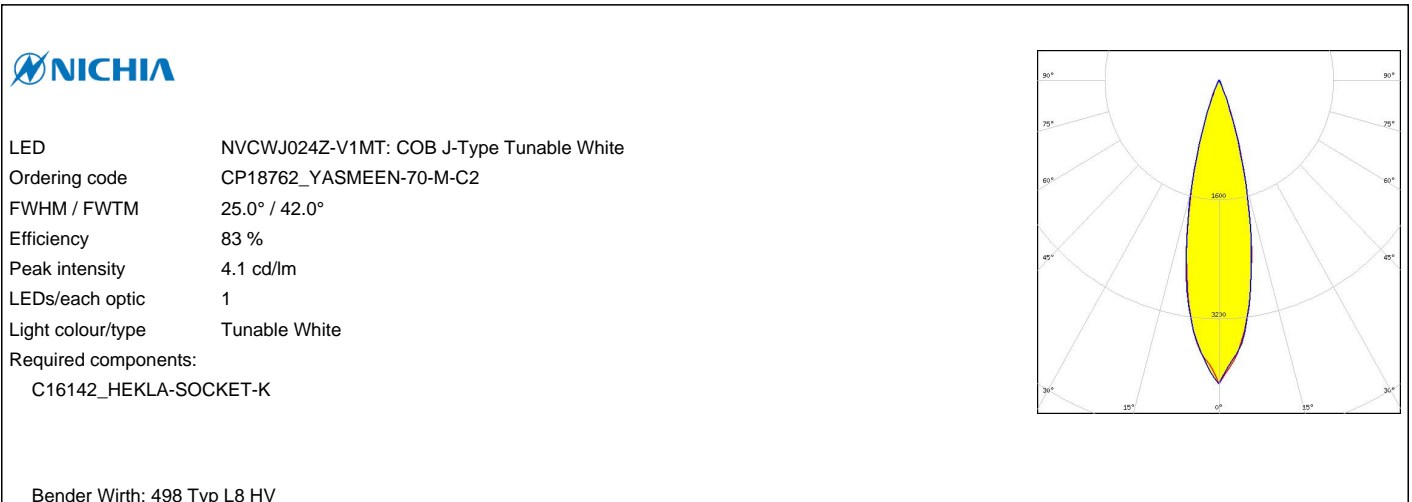

OPTICAL RESULTS (SIMULATED):

SAMSUNG

LED LC010C G2
Ordering code CP18769_YASMEEN-70-M-B2
FWHM / FWTM 28.0° / 42.0°
Efficiency 86 %
Peak intensity 4.1 cd/lm
LEDs/each optic 1
Light colour/type White
Required components:

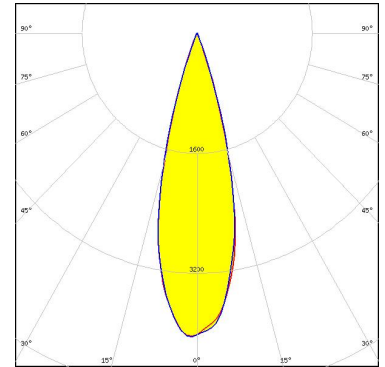

BJB: 47.360.1020

SAMSUNG

LED LC010T (Tunable White)
Ordering code CP18762_YASMEEN-70-M-C2
FWHM / FWTM 28.0° / 42.0°
Efficiency 84 %
Peak intensity 3.9 cd/lm
LEDs/each optic 1
Light colour/type Tunable White
Required components:
C16142_HEKLA-SOCKET-K

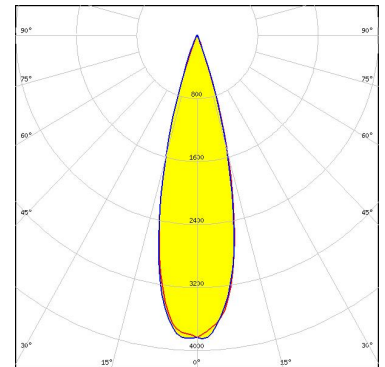

Bender Wirth: 501 Typ L8

SAMSUNG

LED LC016D / LC019D / LC026D / LC033D
Ordering code CP18762_YASMEEN-70-M-C2
FWHM / FWTM 26.0° / 48.0°
Efficiency 81 %
Peak intensity 3.4 cd/lm
LEDs/each optic 1
Light colour/type White
Required components:
F17438_HEKLA-G2-I

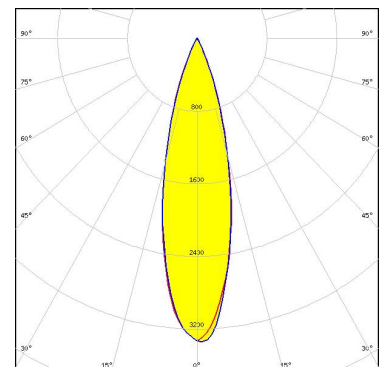

OPTICAL RESULTS (SIMULATED):

SAMSUNG

LED LC020C G2
Ordering code CP18769_YASMEEN-70-M-B2
FWHM / FWTM 28.0° / 42.0°
Efficiency 84 %
Peak intensity 3.9 cd/lm
LEDs/each optic 1
Light colour/type White
Required components:

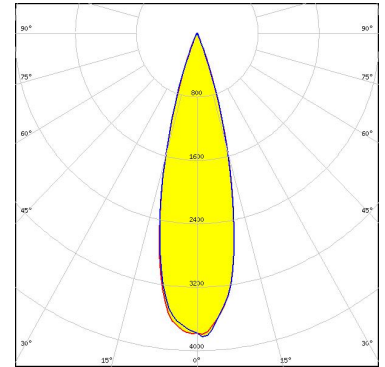

BJB: 47.360.1010

SAMSUNG

LED LC020T (Tunable white)
Ordering code CP18762_YASMEEN-70-M-C2
FWHM / FWTM 26.0° / 44.0°
Efficiency 83 %
Peak intensity 4 cd/lm
LEDs/each optic 1
Light colour/type Tunable White
Required components:
C16142_HEKLA-SOCKET-K

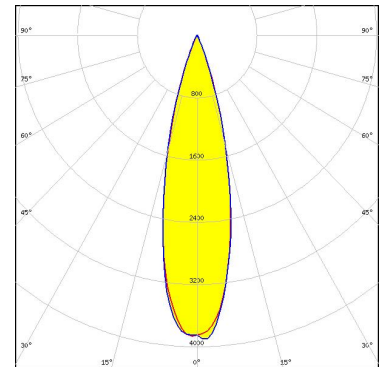

Bender Wirth: 501 Typ L8

SAMSUNG

LED LC030C/040C G2
Ordering code CP18769_YASMEEN-70-M-B2
FWHM / FWTM 26.0° / 44.0°
Efficiency 83 %
Peak intensity 3.9 cd/lm
LEDs/each optic 1
Light colour/type White
Required components:

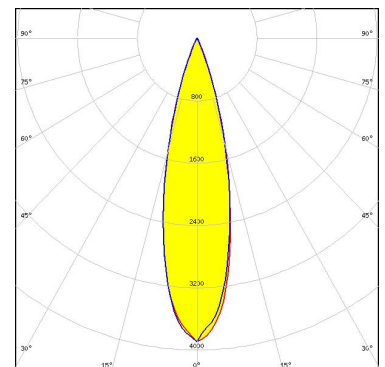

BJB: 47.360.1010

OPTICAL RESULTS (SIMULATED):

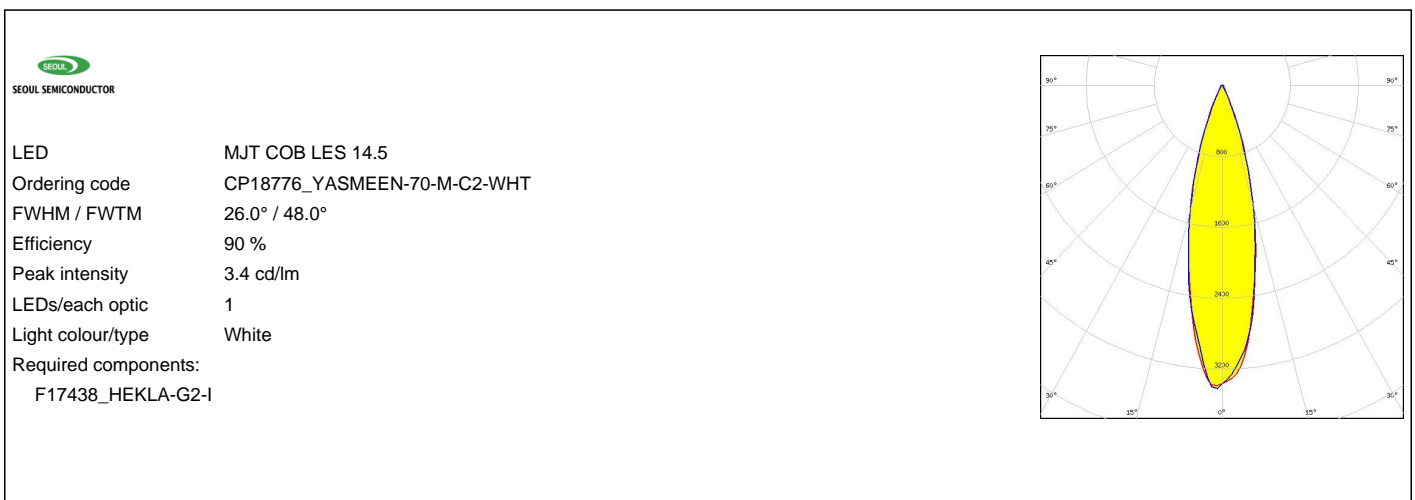
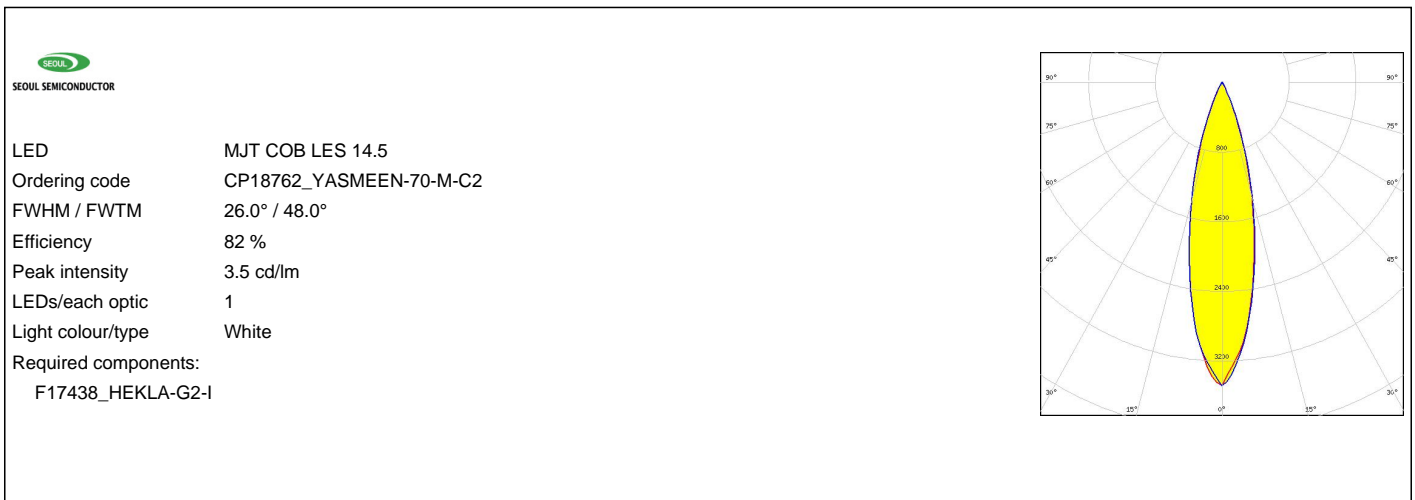
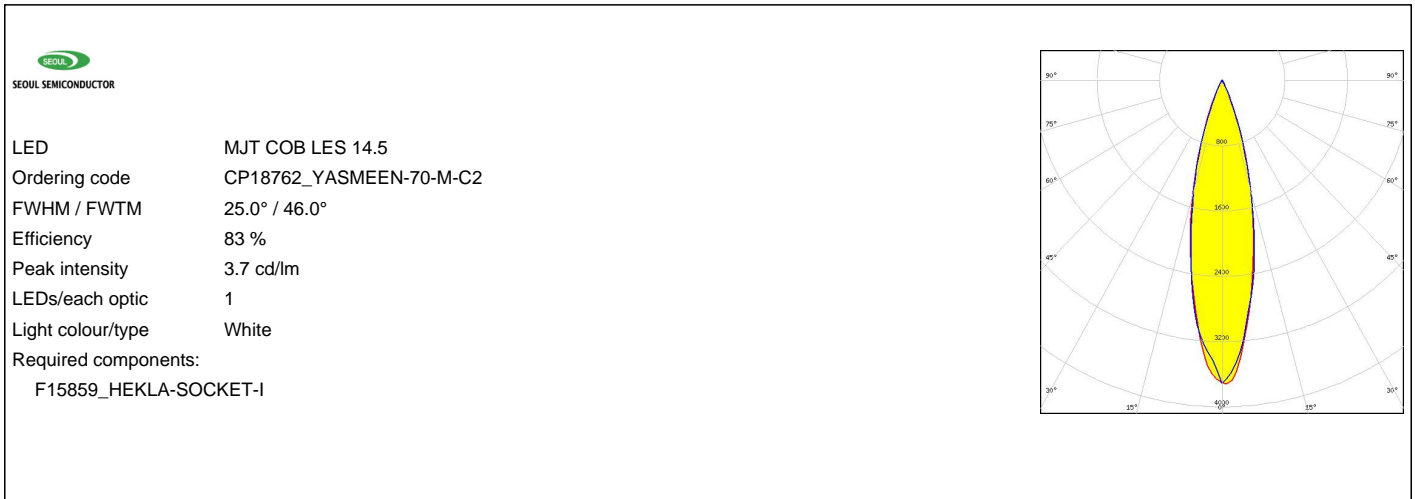

OPTICAL RESULTS (SIMULATED):

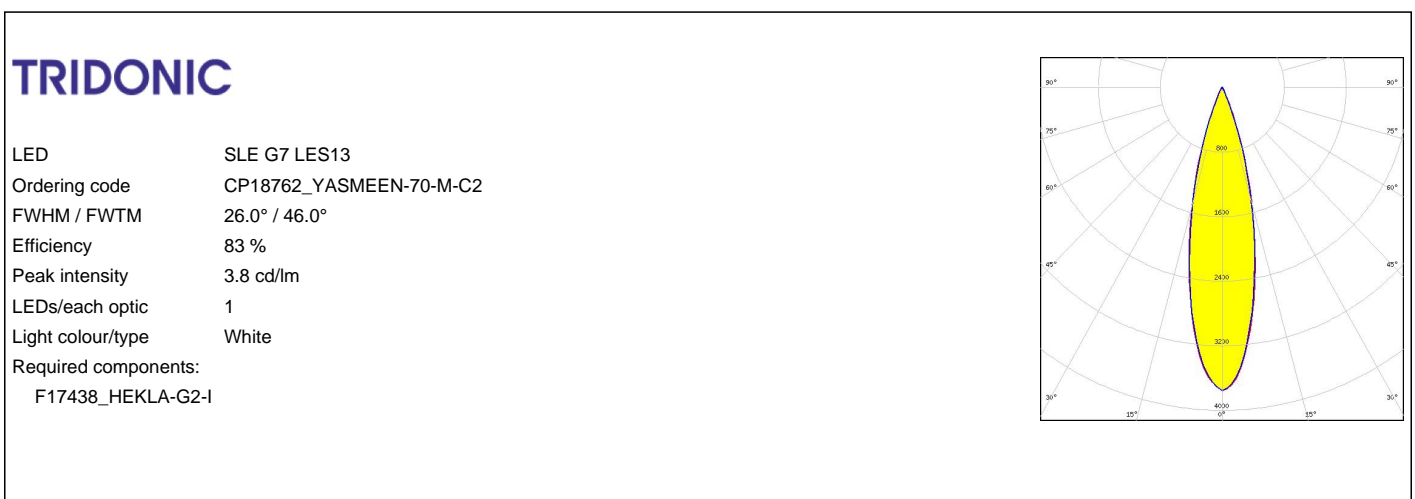
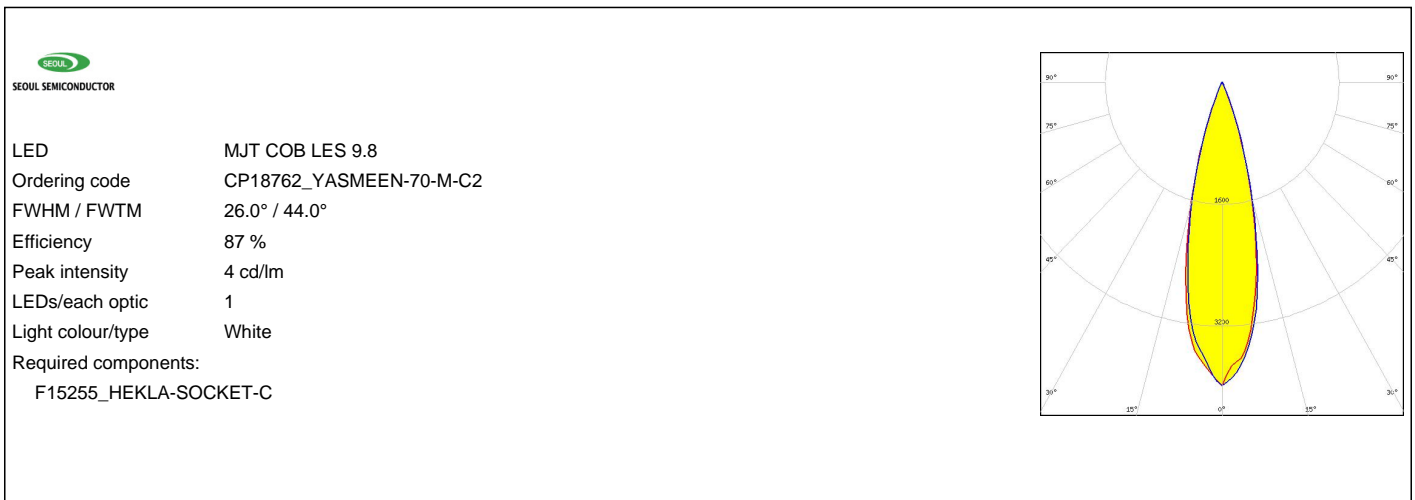
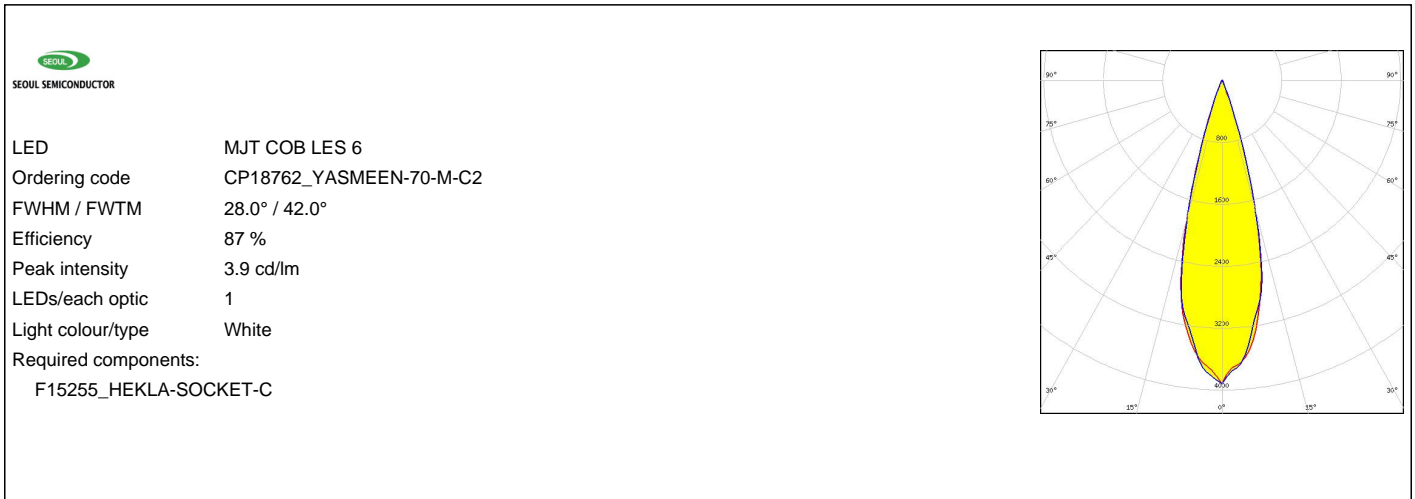

GENERAL INFORMATION:

NOTE: The typical beam angle will be changed by different color, chip size and chip position tolerance. The typical total beam angle is the full angle measured where the luminous intensity is half of the peak value.

Due to use of high power COB's with this product, special attention to proper thermal design is highly recommended. LEDiL has no liability for direct, indirect or consecutive damages arising from the LEDiL products being used outside of the recommended temperature range.

MATERIALS:

As part of our continuous research and improvement processes, and to ensure the best possible quality and availability of our products, LEDiL reserves the right to change material grades without notice.

PRODUCT DATA USER AGREEMENT AND DISCLAIMER:

The measured data in the provided downloadable LEDiL Product Datasheets and Mechanical 2D-Drawings is rounded and provided as reference for planning. LEDiL Oy's optical specifications have been verified by conducting performance testing of the products in accordance with the company's quality system. The reported data are averaged results of multiple measurements with typical variation. LEDiL Oy reserves the right to without prior notification make changes and improvements to its products.

LEDiL Oy assumes neither warranty, nor guarantee nor any other liability of any kind for the contents and correctness of the provided data. The provided data has been generated with highest diligence but the provided data may in reality not represent the complete possible variation range of all intrinsic parameters. Therefore, in certain cases a deviation from the provided data could occur.

LEDiL Oy reserves the right to undertake technical changes of its products without further notification which could lead to changes in the provided data. LEDiL Oy assumes no liability of any kind for the possible deviation from any provided data or any other damage resulting from the usage of the provided data.

The user agrees to this disclaimer and user agreement with the download or usage of the provided files.

LEDiL Oy

Joensuunkatu 13
FI-24240 SALO
Finland

LEDiL Inc.

228 West Page Street
Suite D
Sycamore IL 60178
USA

Ledil Optics Technology (Shenzhen) Co., Ltd.

405 , Block B
Casic Motor Building
Shenzhen 518057
P.R.CHINA

Local sales and technical support

[www.ledil.com/
where_to_buy](http://www.ledil.com/where_to_buy)

Shipping locations

Salo, Finland
Hong Kong, China

Distribution Partners

[www.ledil.com/
where_to_buy](http://www.ledil.com/where_to_buy)