

YASMEEN-70-RS

~10° spot beam

SPECIFICATION:

Dimensions	Ø 70.0
Height	38.4 mm
Fastening	socket
ROHS compliant	yes ⓘ

MATERIALS:

Component	Type	Material	Colour	Finish	Length
YASMEEN-70-RS	Single lens	PMMA	clear		69.9
YASMEEN-70-HLD2-C	Holder C	PC	black		
YASMEEN-70-HLD2-B	Holder B	PC	black		
YASMEEN-70-HLD2-C-WHT	Holder C	PC	white		
YASMEEN-70-HLD2-B-WHT	Holder B	PC	white		



ORDERING INFORMATION:

Component	Qty in box	MOQ	MPQ	Box weight (kg)
CP18579_YASMEEN-70-RS	105	105	15	9.3
Assembly				
CP18788_YASMEEN-70-RS-B2-WHT	105	105	15	11.0
CP18781_YASMEEN-70-RS-C2-WHT	105	105	15	10.9
CP18774_YASMEEN-70-RS-B2	105	105	15	11.0
CP18767_YASMEEN-70-RS-C2	105	105	15	10.6

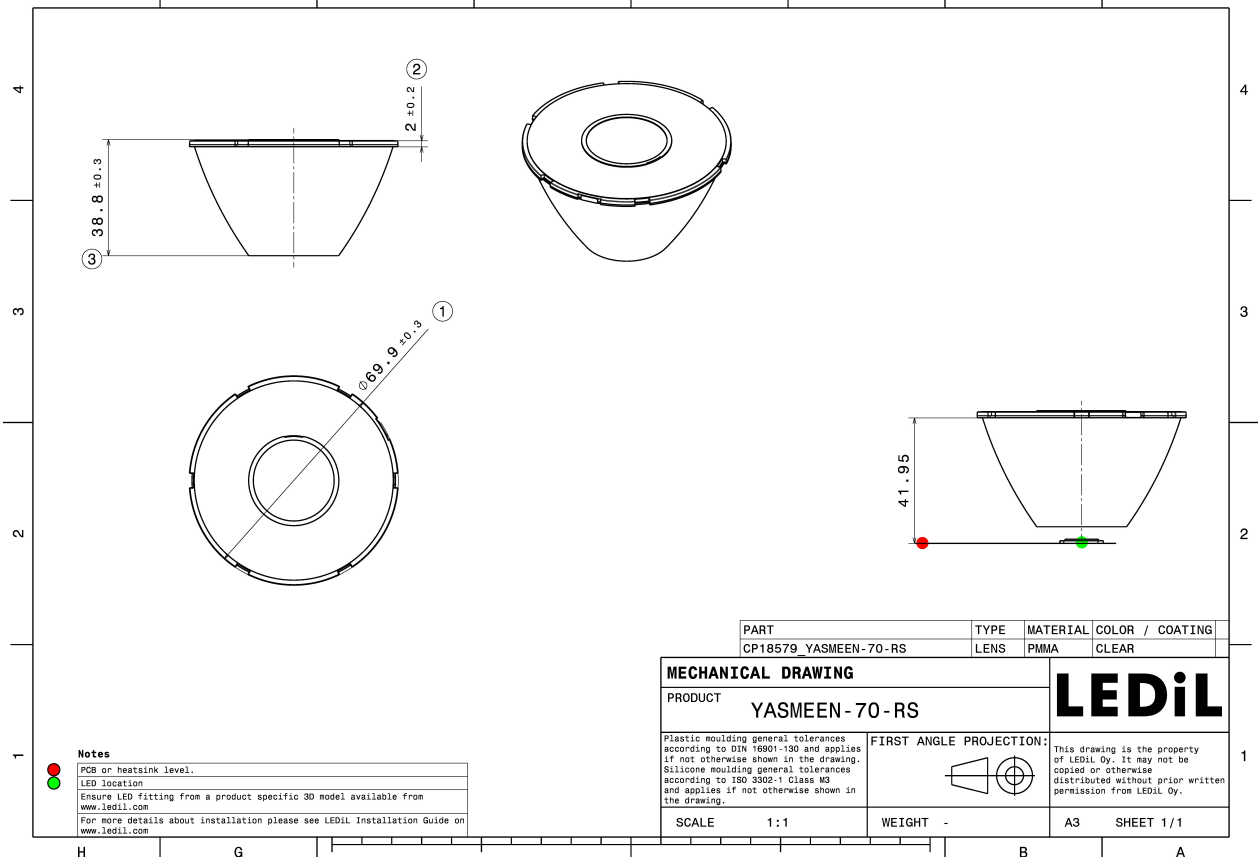
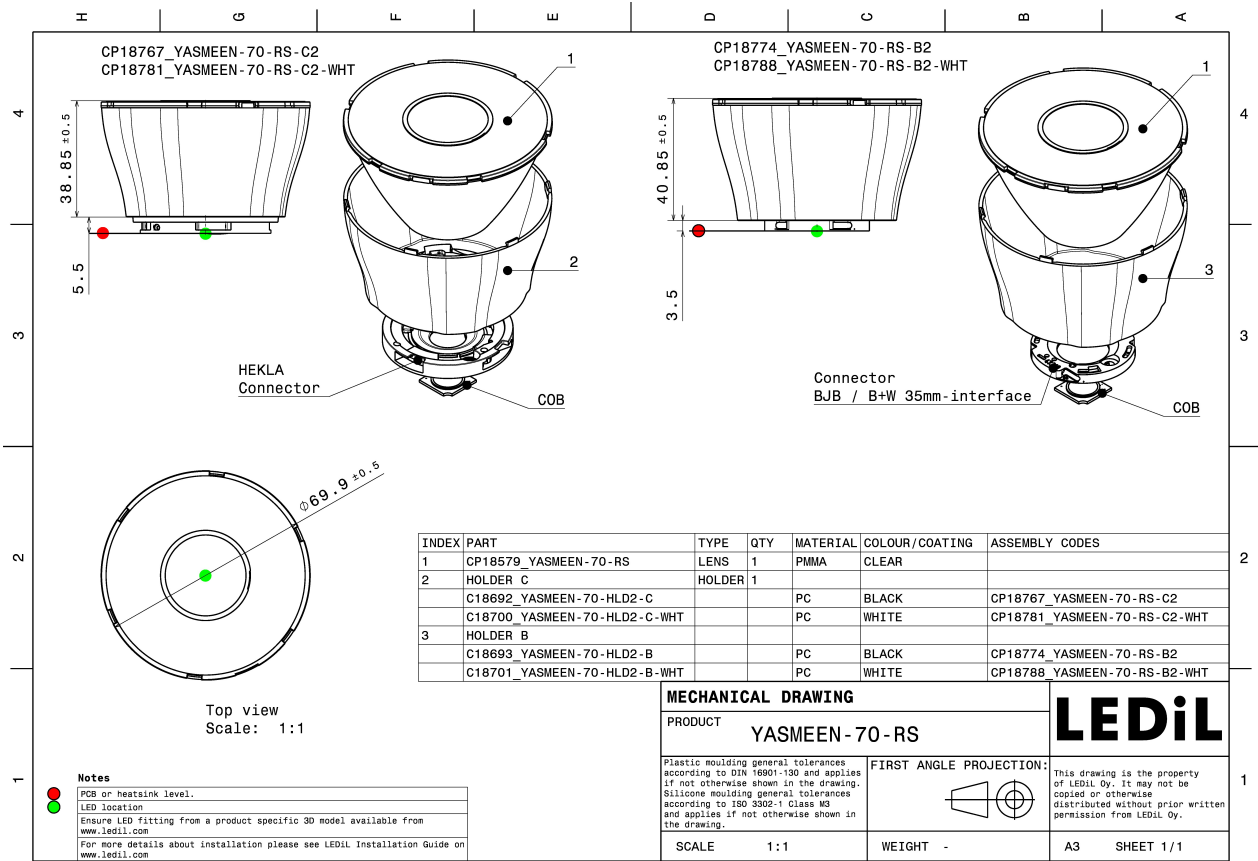

See also our general installation guide: www.ledil.com/installation_guide

OPTICAL RESULTS (MEASURED):

SAMSUNG

LED LC010C G2
Ordering code CP18767_YASMEEN-70-RS-C2
FWHM / FWTM 10.0° / 18.0°
Efficiency 88 %
Peak intensity 24.2 cd/lm
LEDs/each optic 1
Light colour/type White
Required components:
F17435_HEKLA-G2-C

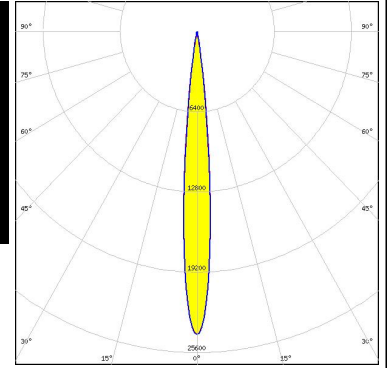
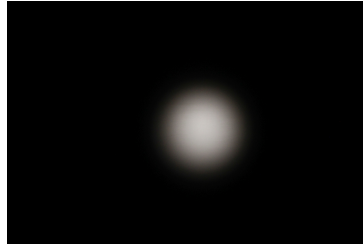

OPTICAL RESULTS (SIMULATED):



LED V10 Gen 8-9
Ordering code CP18767_YASMEEN-70-RS-C2
FWHM / FWTM 14.0° / 26.0°
Efficiency 90 %
Peak intensity 12.6 cd/lm
LEDs/each optic 1
Light colour/type White
Required components:
F15255_HEKLA-SOCKET-C

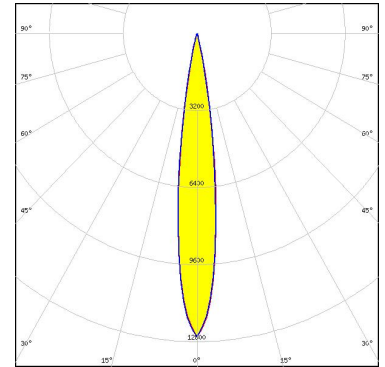

LED V4 HD Gen 8
Ordering code CP18767_YASMEEN-70-RS-C2
FWHM / FWTM 8.0° / 16.0°
Efficiency 90 %
Peak intensity 35.5 cd/lm
LEDs/each optic 1
Light colour/type White
Required components:
F15253_HEKLA-SOCKET-A

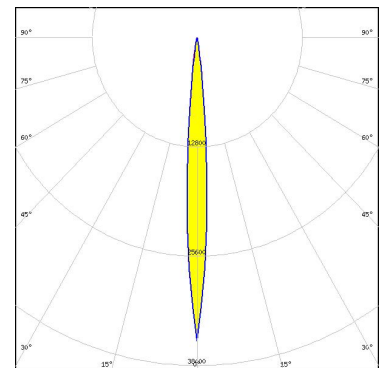



LED	Vesta SE 13mm TW
Ordering code	CP18767_YASMEEN-70-RS-C2
FWHM / FWTM	18.0° / 36.0°
Efficiency	86 %
Peak intensity	6.9 cd/lm
LEDs/each optic	1
Light colour/type	Tunable White
Required components:	
	C16142_HEKLA-SOCKET-K

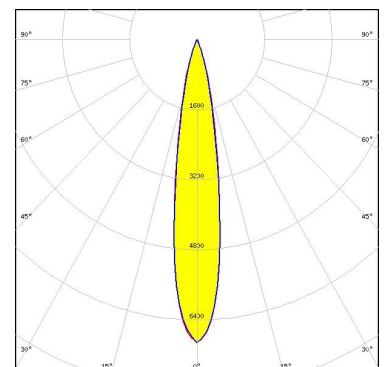

OPTICAL RESULTS (SIMULATED):

CITIZEN

LED CLL02x/CLU02x (LES10)
 Ordering code CP18767_YASMEEN-70-RS-C2
 FWHM / FWTM 17.0° / 30.0°
 Efficiency 90 %
 Peak intensity 8.5 cd/lm
 LEDs/each optic 1
 Light colour/type White
 Required components:
 F17435_HEKLA-G2-C

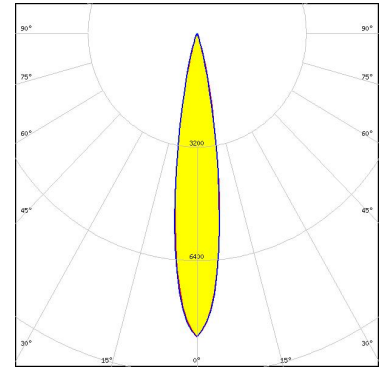

CITIZEN

LED CLL02x/CLU02x (LES10)
 Ordering code CP18579_YASMEEN-70-RS
 FWHM / FWTM 16.0° / 26.0°
 Efficiency 95 %
 Peak intensity 11.7 cd/lm
 LEDs/each optic 1
 Light colour/type White
 Required components:

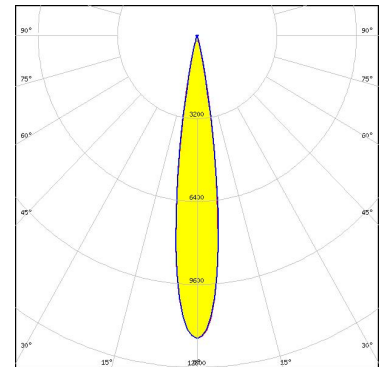

CITIZEN

LED CLL02x/CLU02x (LES10)
 Ordering code CP18774_YASMEEN-70-RS-B2
 FWHM / FWTM 16.0° / 26.0°
 Efficiency 90 %
 Peak intensity 12 cd/lm
 LEDs/each optic 1
 Light colour/type White
 Required components:

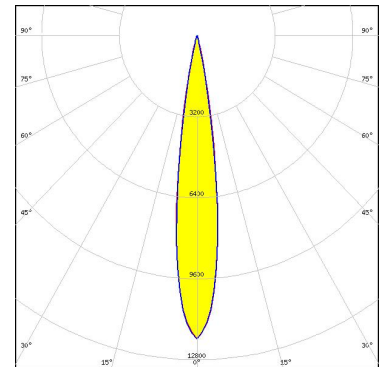

BJB: 47.360.1020

OPTICAL RESULTS (SIMULATED):

CITIZEN

LED CLL02x/CLU02x (LES10)
Ordering code CP18781_YASMEEN-70-RS-C2-WHT
FWHM / FWTM 16.0° / 26.0°
Efficiency 93 %
Peak intensity 11.8 cd/lm
LEDs/each optic 1
Light colour/type White
Required components:
F17435_HEKLA-G2-C

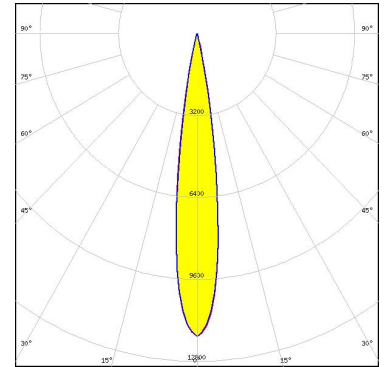

CITIZEN

LED CLL02x/CLU02x (LES10)
Ordering code CP18788_YASMEEN-70-RS-B2-WHT
FWHM / FWTM 16.0° / 26.0°
Efficiency 93 %
Peak intensity 11.9 cd/lm
LEDs/each optic 1
Light colour/type White
Required components:

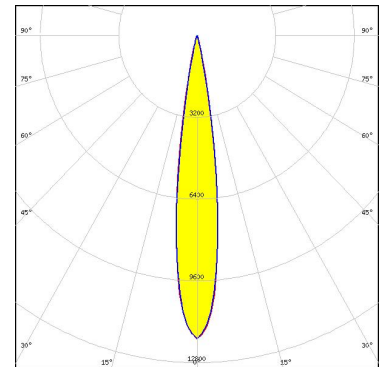

BJB: 47.360.1020

CITIZEN

LED CLU700/701/702/703
Ordering code CP18781_YASMEEN-70-RS-C2-WHT
FWHM / FWTM 10.0° / 18.0°
Efficiency 93 %
Peak intensity 24.1 cd/lm
LEDs/each optic 1
Light colour/type White
Required components:
F17435_HEKLA-G2-C

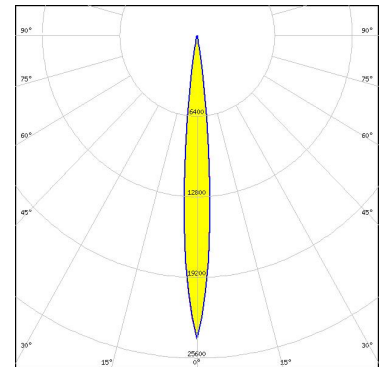

OPTICAL RESULTS (SIMULATED):

CITIZEN

LED CLU700/701/702/703
Ordering code CP18788_YASMEEN-70-RS-B2-WHT
FWHM / FWTM 10.0° / 18.0°
Efficiency 93 %
Peak intensity 24.2 cd/lm
LEDs/each optic 1
Light colour/type White
Required components:

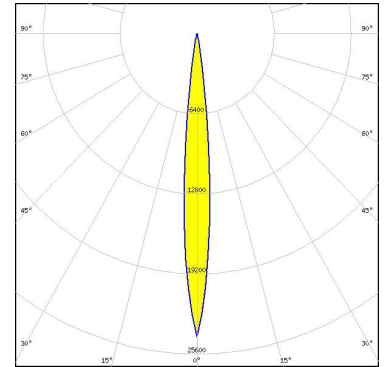

BJB: 47.360.1020

CITIZEN

LED CLU700/701/702/703
Ordering code CP18579_YASMEEN-70-RS
FWHM / FWTM 10.0° / 18.0°
Efficiency 95 %
Peak intensity 24.2 cd/lm
LEDs/each optic 1
Light colour/type White
Required components:

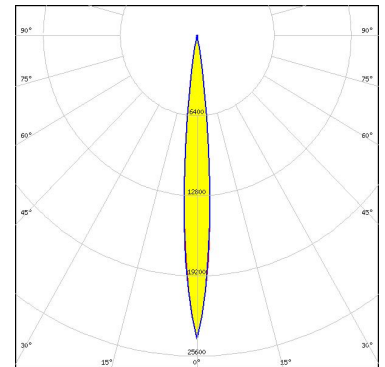

CITIZEN

LED CLU700/701/702/703
Ordering code CP18774_YASMEEN-70-RS-B2
FWHM / FWTM 10.0° / 18.0°
Efficiency 90 %
Peak intensity 24.1 cd/lm
LEDs/each optic 1
Light colour/type White
Required components:

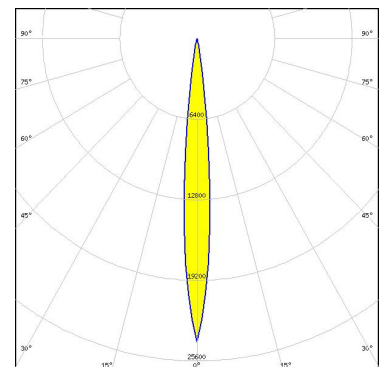

BJB: 47.360.1020

OPTICAL RESULTS (SIMULATED):

CITIZEN

LED CLU7A2/7A3
Ordering code CP18579_YASMEEN-70-RS
FWHM / FWTM 8.0° / 16.0°
Efficiency 94 %
Peak intensity 36.6 cd/lm
LEDs/each optic 1
Light colour/type White
Required components:

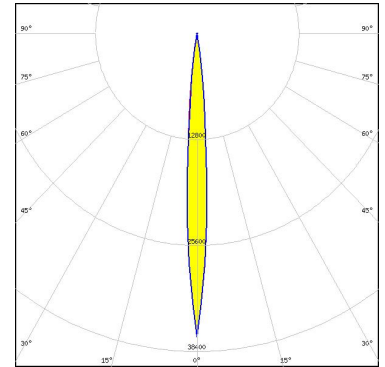

CITIZEN

LED CLU7A2/7A3
Ordering code CP18788_YASMEEN-70-RS-B2-WHT
FWHM / FWTM 8.0° / 16.0°
Efficiency 93 %
Peak intensity 36.9 cd/lm
LEDs/each optic 1
Light colour/type White
Required components:

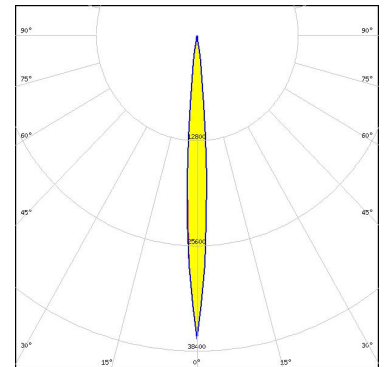

BJB: 47.360.1020

CITIZEN

LED CLU7A2/7A3
Ordering code CP18774_YASMEEN-70-RS-B2
FWHM / FWTM 8.0° / 16.0°
Efficiency 90 %
Peak intensity 36.6 cd/lm
LEDs/each optic 1
Light colour/type White
Required components:

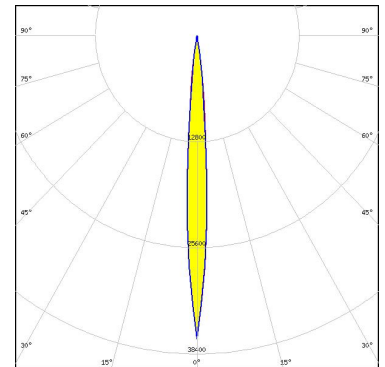

BJB: 47.360.1020

OPTICAL RESULTS (SIMULATED):

CITIZEN

LED CLU7A2/7A3
Ordering code CP18774_YASMEEN-70-RS-B2
FWHM / FWTM 8.0° / 16.0°
Efficiency 89 %
Peak intensity 35.6 cd/lm
LEDs/each optic 1
Light colour/type White
Required components:
C18968_SOCKET-B-35-C

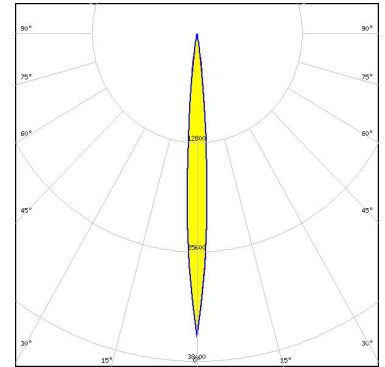

CITIZEN

LED CLU7A2/7A3
Ordering code CP18781_YASMEEN-70-RS-C2-WHT
FWHM / FWTM 8.0° / 16.0°
Efficiency 93 %
Peak intensity 36.5 cd/lm
LEDs/each optic 1
Light colour/type White
Required components:
F17435_HEKLA-G2-C

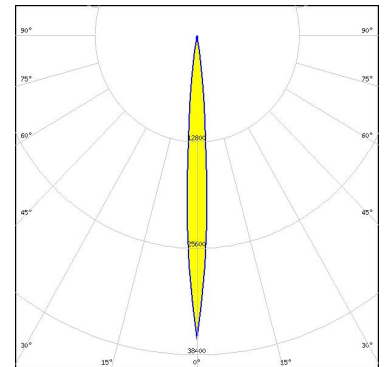

CITIZEN

LED CLU7A3 Type-F
Ordering code CP18774_YASMEEN-70-RS-B2
FWHM / FWTM 10.0° / 20.0°
Efficiency 88 %
Peak intensity 23.8 cd/lm
LEDs/each optic 1
Light colour/type White
Required components:
C18968_SOCKET-B-35-C

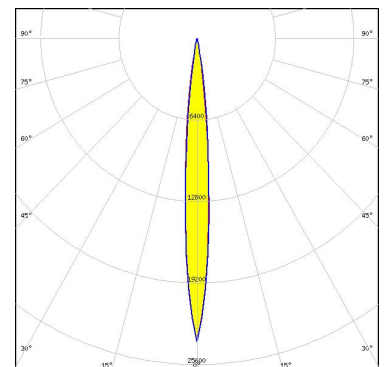

OPTICAL RESULTS (SIMULATED):

CITIZEN

LED CLU7L3
 Ordering code CP18774_YASMEEN-70-RS-B2
 FWHM / FWTM 6.0° / 14.0°
 Efficiency 85 %
 Peak intensity 46.1 cd/lm
 LEDs/each optic 1
 Light colour/type White
 Required components:
 C19425_SOCKET-B-35-N

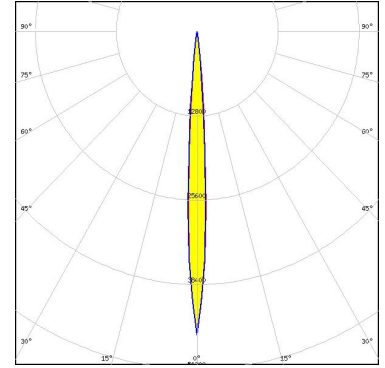

CITIZEN

LED CLU7S3
 Ordering code CP18774_YASMEEN-70-RS-B2
 FWHM / FWTM 8.0° / 16.0°
 Efficiency 87 %
 Peak intensity 39.1 cd/lm
 LEDs/each optic 1
 Light colour/type White
 Required components:
 C19425_SOCKET-B-35-N

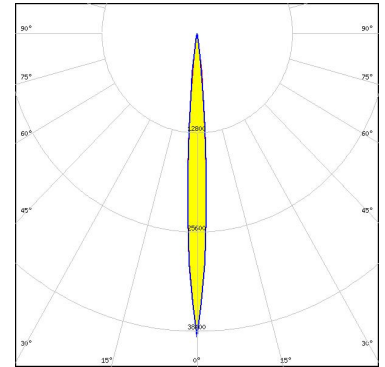

CITIZEN

LED CLU7S3
 Ordering code CP18788_YASMEEN-70-RS-B2-WHT
 FWHM / FWTM 8.0° / 16.0°
 Efficiency 93 %
 Peak intensity 37.9 cd/lm
 LEDs/each optic 1
 Light colour/type White
 Required components:

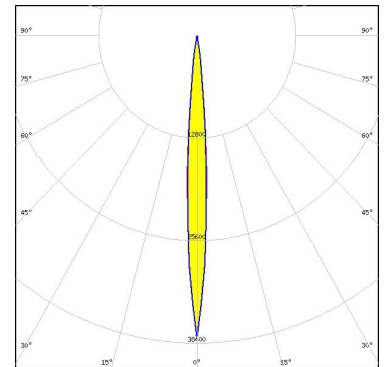

Bender Wirth: 667a Bayonet35

OPTICAL RESULTS (SIMULATED):

CITIZEN

LED	CLU7S3
Ordering code	CP18774_YASMEEN-70-RS-B2
FWHM / FWTM	8.0° / 16.0°
Efficiency	90 %
Peak intensity	37.6 cd/lm
LEDs/each optic	1
Light colour/type	White
Required components:	

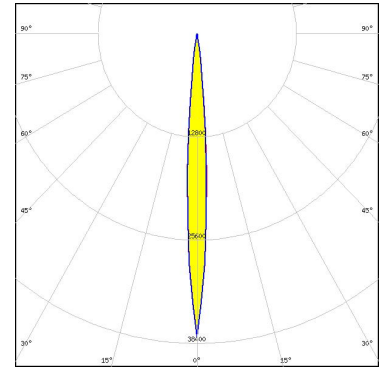

Bender Wirth: 667a Bayonet35



LED	CMA1840
Ordering code	CP18767_YASMEEN-70-RS-C2
FWHM / FWTM	22.0° / 36.0°
Efficiency	89 %
Peak intensity	5.9 cd/lm
LEDs/each optic	1
Light colour/type	White
Required components:	

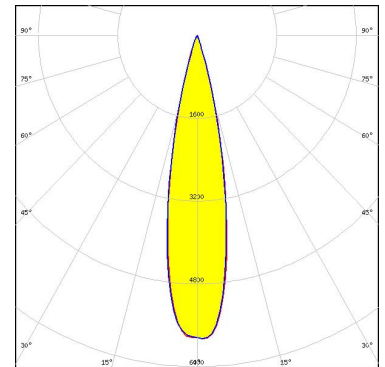

Bender Wirth: 637a Hekla



LED	CMU15xx
Ordering code	CP18767_YASMEEN-70-RS-C2
FWHM / FWTM	20.0° / 36.0°
Efficiency	89 %
Peak intensity	6.3 cd/lm
LEDs/each optic	1
Light colour/type	White
Required components:	F17438_HEKLA-G2-I

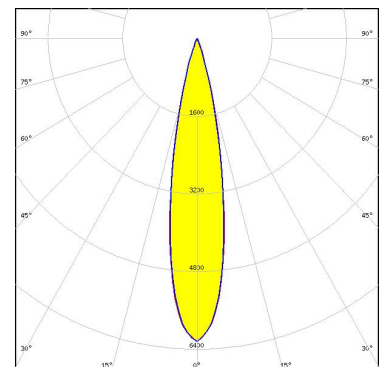

OPTICAL RESULTS (SIMULATED):



LED CXA/B 13xx
Ordering code CP18767_YASMEEN-70-RS-C2
FWHM / FWTM 10.0° / 18.0°
Efficiency 88 %
Peak intensity 26.5 cd/lm
LEDs/each optic 1
Light colour/type White
Required components:
F17439_HEKLA-G2-J

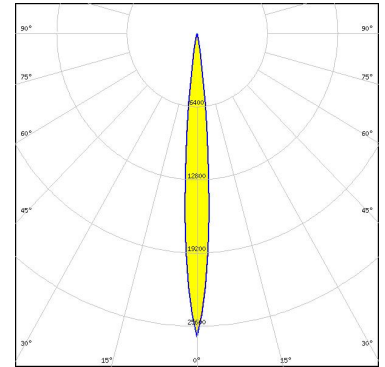

LED CxM-9 (13.5x13.5)
Ordering code CP18767_YASMEEN-70-RS-C2
FWHM / FWTM 16.0° / 26.0°
Efficiency 90 %
Peak intensity 11.6 cd/lm
LEDs/each optic 1
Light colour/type White
Required components:
F17435_HEKLA-G2-C

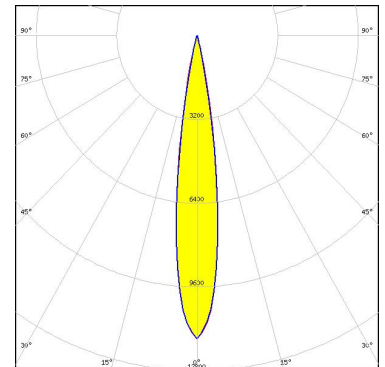

LED LC003D / LC006D / LC009D / LC013D
Ordering code CP18781_YASMEEN-70-RS-C2-WHT
FWHM / FWTM 16.0° / 26.0°
Efficiency 93 %
Peak intensity 11.2 cd/lm
LEDs/each optic 1
Light colour/type White
Required components:
F17435_HEKLA-G2-C

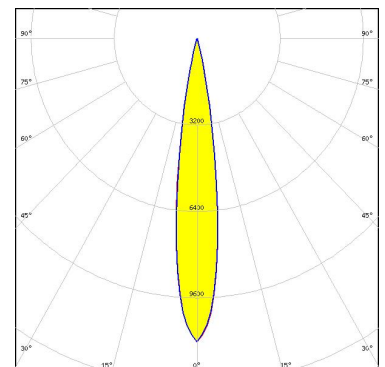

OPTICAL RESULTS (SIMULATED):

SAMSUNG

LED LC003D / LC006D / LC009D / LC013D
Ordering code CP18767_YASMEEN-70-RS-C2
FWHM / FWTM 16.0° / 26.0°
Efficiency 90 %
Peak intensity 11.3 cd/lm
LEDs/each optic 1
Light colour/type White
Required components:
F17435_HEKLA-G2-C

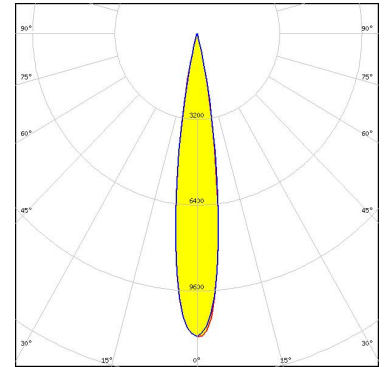

SAMSUNG

LED LC003D / LC006D / LC009D / LC013D
Ordering code CP18788_YASMEEN-70-RS-B2-WHT
FWHM / FWTM 16.0° / 26.0°
Efficiency 92 %
Peak intensity 11.1 cd/lm
LEDs/each optic 1
Light colour/type White
Required components:

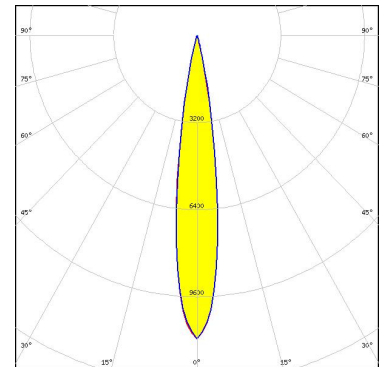

BJB: 47.360.1020

SAMSUNG

LED LC003D / LC006D / LC009D / LC013D
Ordering code CP18579_YASMEEN-70-RS
FWHM / FWTM 16.0° / 26.0°
Efficiency 95 %
Peak intensity 11.3 cd/lm
LEDs/each optic 1
Light colour/type White
Required components:

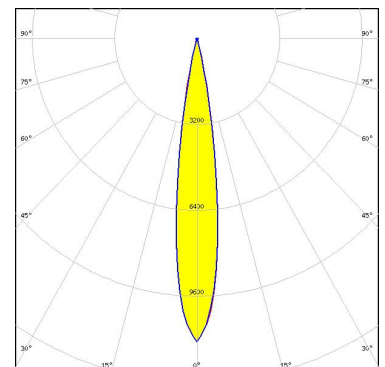

OPTICAL RESULTS (SIMULATED):

SAMSUNG

LED	LC003D / LC006D / LC009D / LC013D
Ordering code	CP18774_YASMEEN-70-RS-B2
FWHM / FWTM	16.0° / 26.0°
Efficiency	89 %
Peak intensity	11.1 cd/lm
LEDs/each optic	1
Light colour/type	White
Required components:	

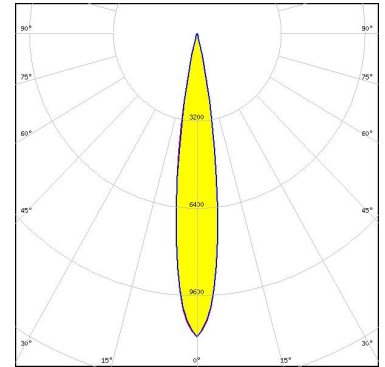

BJB: 47.360.1020

SAMSUNG

LED	LC003D / LC006D / LC009D / LC013D
Ordering code	CP18767_YASMEEN-70-RS-C2
FWHM / FWTM	16.0° / 26.0°
Efficiency	88 %
Peak intensity	11.4 cd/lm
LEDs/each optic	1
Light colour/type	White
Required components:	F17435_HEKLA-G2-C

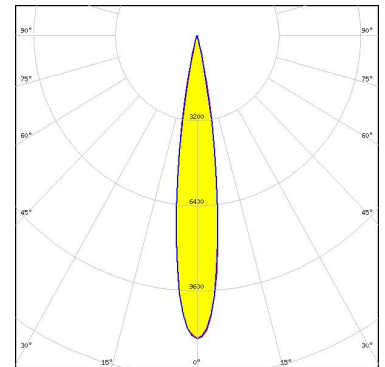

SAMSUNG

LED	LC016D / LC019D / LC026D / LC033D
Ordering code	CP18767_YASMEEN-70-RS-C2
FWHM / FWTM	22.0° / 38.0°
Efficiency	86 %
Peak intensity	5.5 cd/lm
LEDs/each optic	1
Light colour/type	White
Required components:	F17438_HEKLA-G2-I

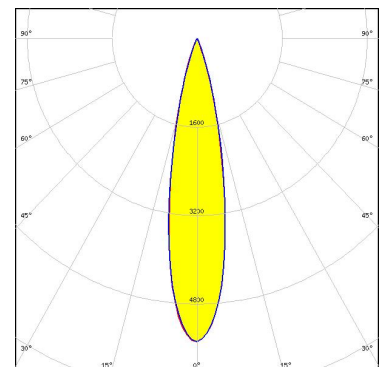

OPTICAL RESULTS (SIMULATED):

SAMSUNG

LED	LC016D / LC019D / LC026D / LC033D
Ordering code	CP18767_YASMEEN-70-RS-C2
FWHM / FWTM	22.0° / 38.0°
Efficiency	88 %
Peak intensity	5.3 cd/lm
LEDs/each optic	1
Light colour/type	White
Required components:	
	F17438_HEKLA-G2-I

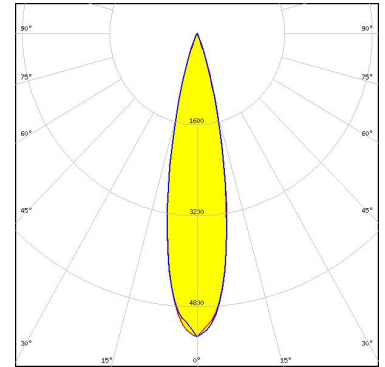

Light distribution files

XICATO

LED	XOB 4mm
Ordering code	CP18767_YASMEEN-70-RS-C2
FWHM / FWTM	8.0° / 14.0°
Efficiency	91 %
Peak intensity	41.2 cd/lm
LEDs/each optic	1
Light colour/type	White
Required components:	

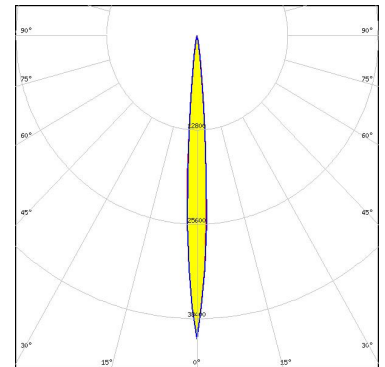

Bender Wirth: 634b Hekla

XICATO

LED	XOB 6 mm
Ordering code	CP18767_YASMEEN-70-RS-C2
FWHM / FWTM	10.0° / 18.0°
Efficiency	90 %
Peak intensity	27.9 cd/lm
LEDs/each optic	1
Light colour/type	White
Required components:	

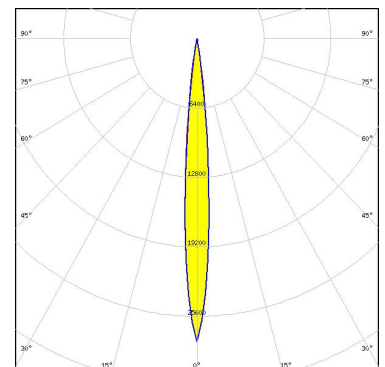

Bender Wirth: 634b Hekla

OPTICAL RESULTS (SIMULATED):

XICATO

LED	XOB 9.8 mm
Ordering code	CP18767_YASMEEN-70-RS-C2
FWHM / FWTM	14.0° / 24.0°
Efficiency	90 %
Peak intensity	15.3 cd/lm
LEDs/each optic	1
Light colour/type	White
Required components:	
F17435_HEKLA-G2-C	

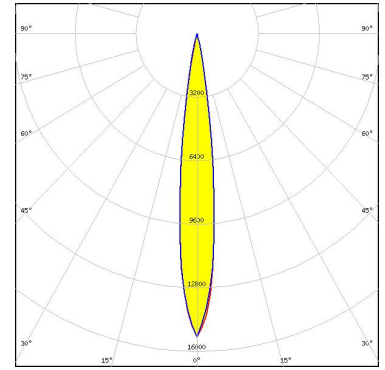

GENERAL INFORMATION:

NOTE: The typical beam angle will be changed by different color, chip size and chip position tolerance. The typical total beam angle is the full angle measured where the luminous intensity is half of the peak value.

Due to use of high power COB's with this product, special attention to proper thermal design is highly recommended. LEDiL has no liability for direct, indirect or consecutive damages arising from the LEDiL products being used outside of the recommended temperature range.

MATERIALS:

As part of our continuous research and improvement processes, and to ensure the best possible quality and availability of our products, LEDiL reserves the right to change material grades without notice.

PRODUCT DATA USER AGREEMENT AND DISCLAIMER:

The measured data in the provided downloadable LEDiL Product Datasheets and Mechanical 2D-Drawings is rounded and provided as reference for planning. LEDiL Oy's optical specifications have been verified by conducting performance testing of the products in accordance with the company's quality system. The reported data are averaged results of multiple measurements with typical variation. LEDiL Oy reserves the right to without prior notification make changes and improvements to its products.

LEDiL Oy assumes neither warranty, nor guarantee nor any other liability of any kind for the contents and correctness of the provided data. The provided data has been generated with highest diligence but the provided data may in reality not represent the complete possible variation range of all intrinsic parameters. Therefore, in certain cases a deviation from the provided data could occur.

LEDiL Oy reserves the right to undertake technical changes of its products without further notification which could lead to changes in the provided data. LEDiL Oy assumes no liability of any kind for the possible deviation from any provided data or any other damage resulting from the usage of the provided data.

The user agrees to this disclaimer and user agreement with the download or usage of the provided files.

LEDiL Oy

Joensuunkatu 13
FI-24240 SALO
Finland

LEDiL Inc.

228 West Page Street
Suite D
Sycamore IL 60178
USA

Ledil Optics Technology (Shenzhen) Co., Ltd.

405 , Block B
Casic Motor Building
Shenzhen 518057
P.R.CHINA

Local sales and technical support

[www.ledil.com/
where_to_buy](http://www.ledil.com/where_to_buy)

Shipping locations

Salo, Finland
Hong Kong, China

Distribution Partners

[www.ledil.com/
where_to_buy](http://www.ledil.com/where_to_buy)