

## YASMEEN-50-S

~15° spot beam

### SPECIFICATION:

Dimensions	Ø 49.9 mm
Height	28.5 mm
Fastening	socket
ROHS compliant	yes ⓘ

### MATERIALS:

Component	Type	Material	Colour	Finish
YASMEEN-50-S	Single lens	PMMA	clear	
YASMEEN-50-HLD2-C	Holder C	PC	black	
YASMEEN-50-HLD2-B	Holder B	PC	black	
YASMEEN-50-HLD2-C-WHT	Holder C	PC	white	
YASMEEN-50-HLD2-B-WHT	Holder B	PC	white	



### ORDERING INFORMATION:

Component	Qty in box	MOQ	MPQ	Box weight (kg)
C17234_YASMEEN-50-S	252	112	28	7.0
<b>Assembly</b>				
CP18744_YASMEEN-50-S-B2-WHT	252	112	28	8.4
CP18737_YASMEEN-50-S-C2-WHT	252	112	28	8.2
CP18730_YASMEEN-50-S-B2	252	112	28	8.4
CP18723_YASMEEN-50-S-C2	252	112	28	8.2

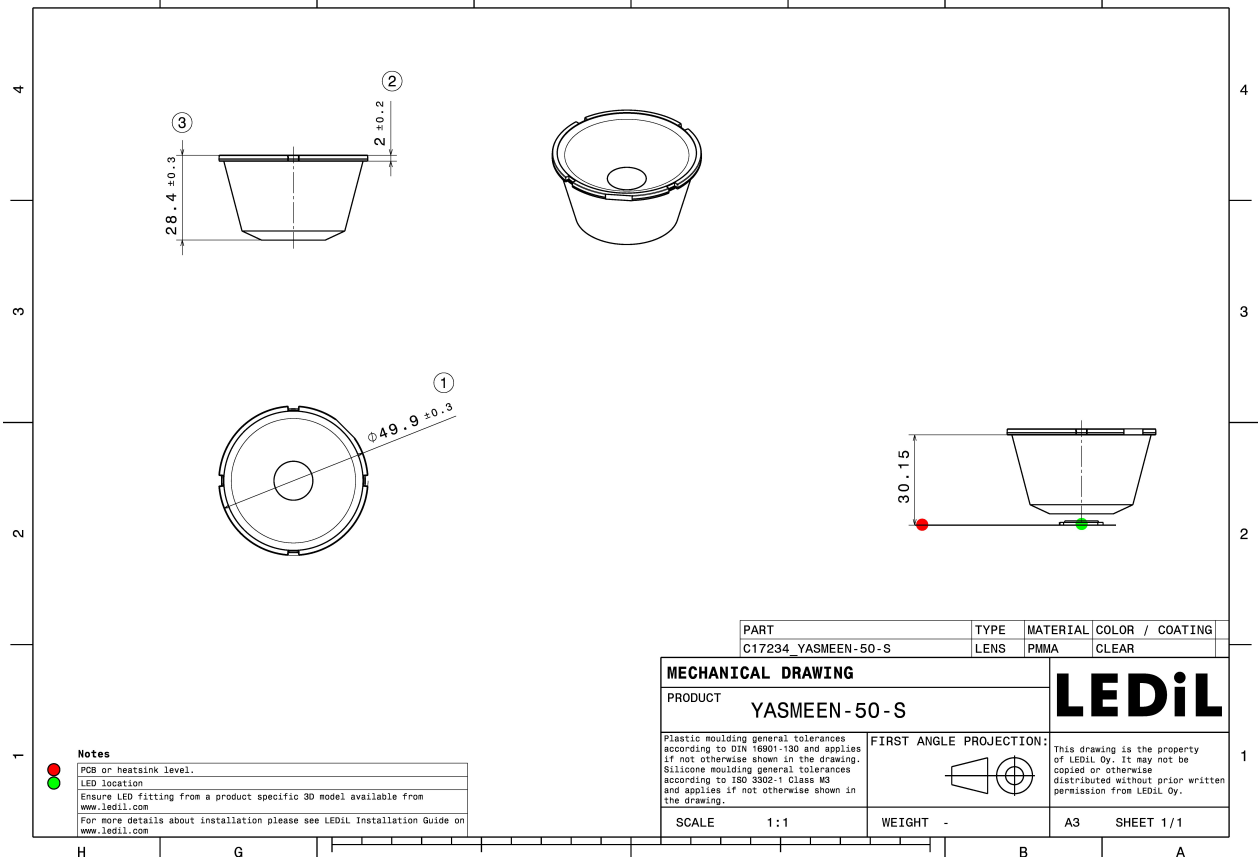
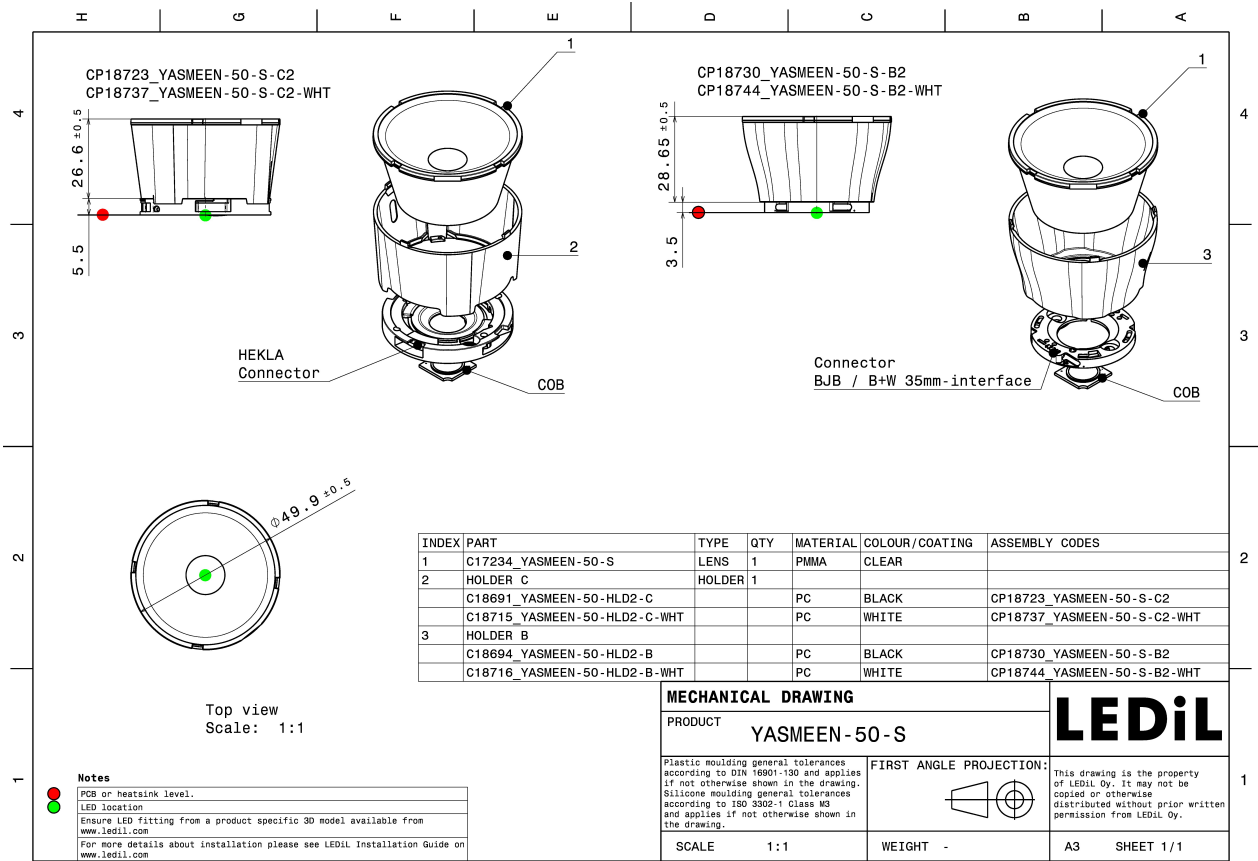

See also our general installation guide: [www.ledil.com/installation\\_guide](http://www.ledil.com/installation_guide)

### OPTICAL RESULTS (MEASURED):

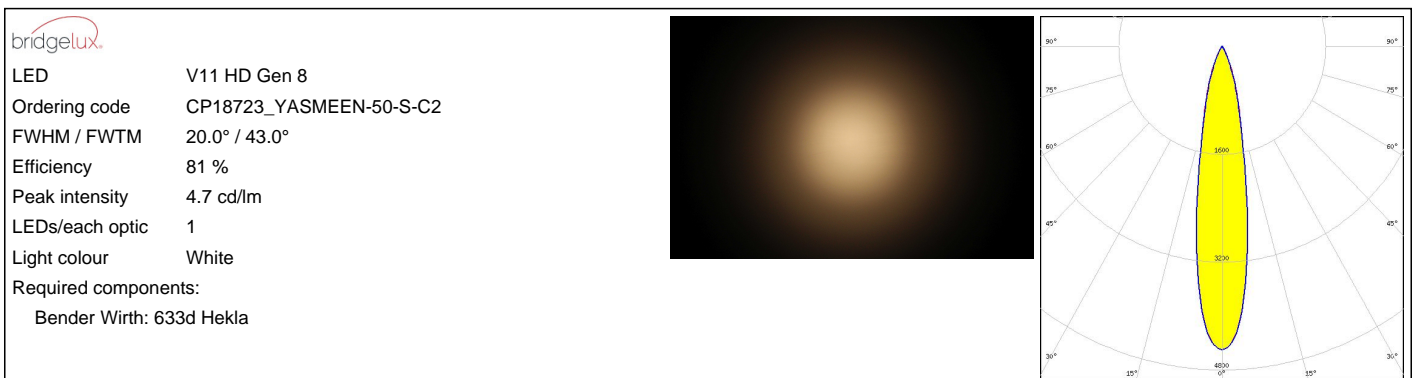
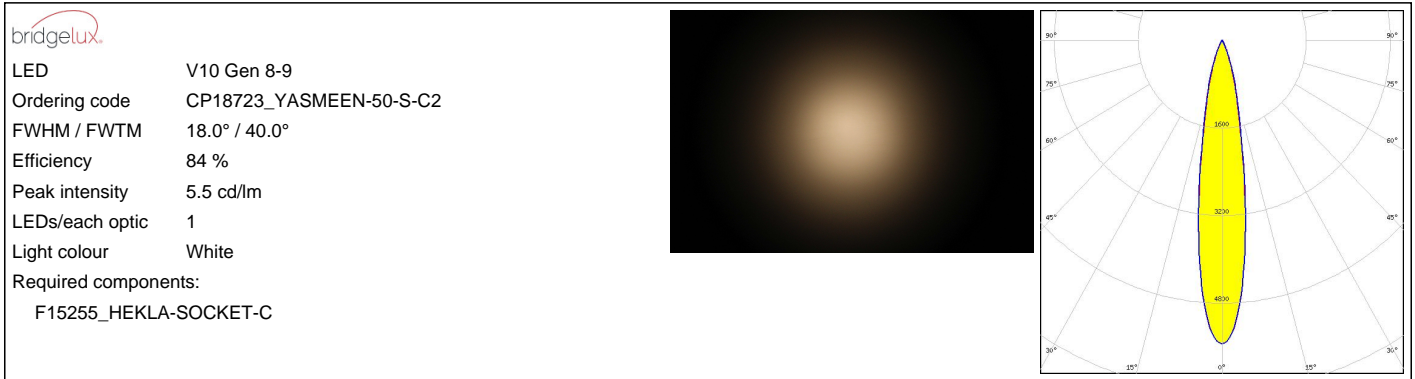

### OPTICAL RESULTS (MEASURED):

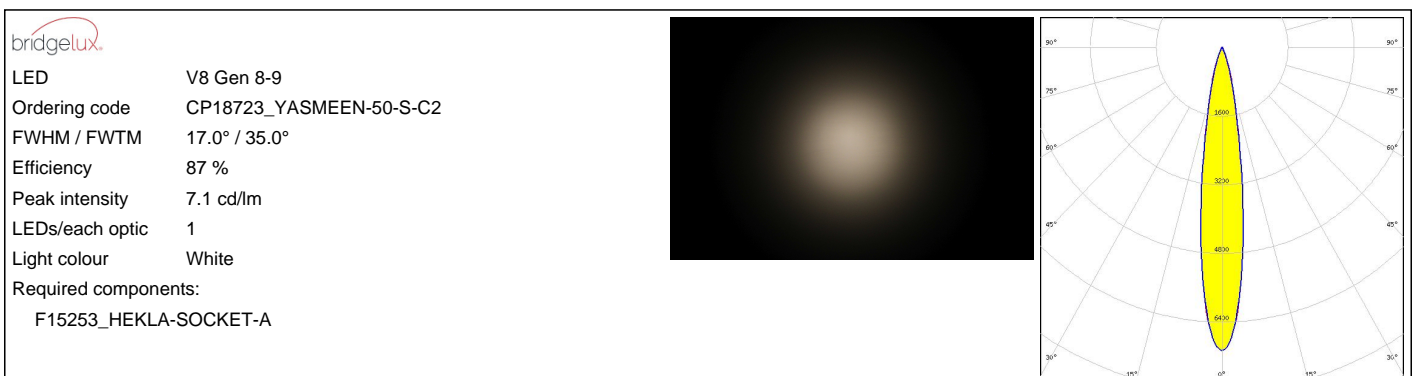
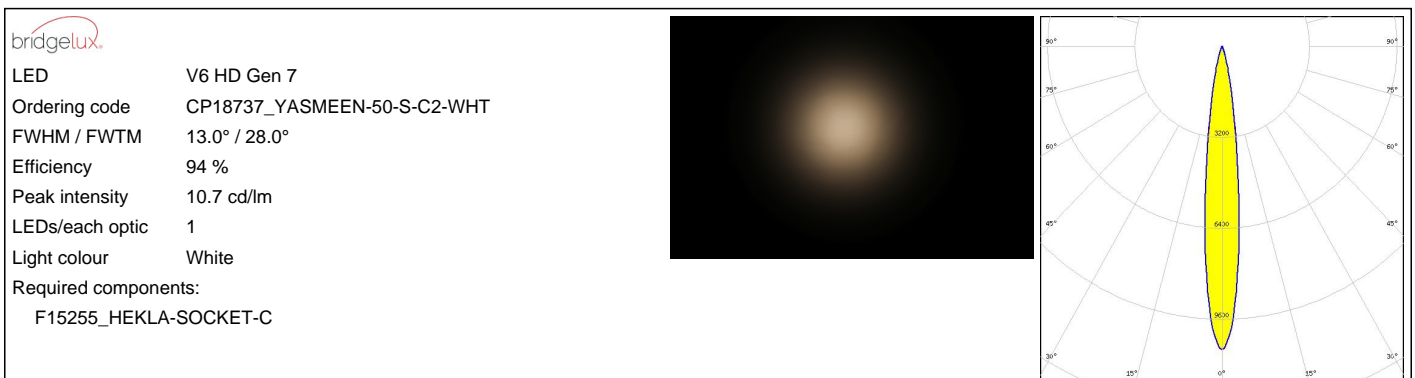
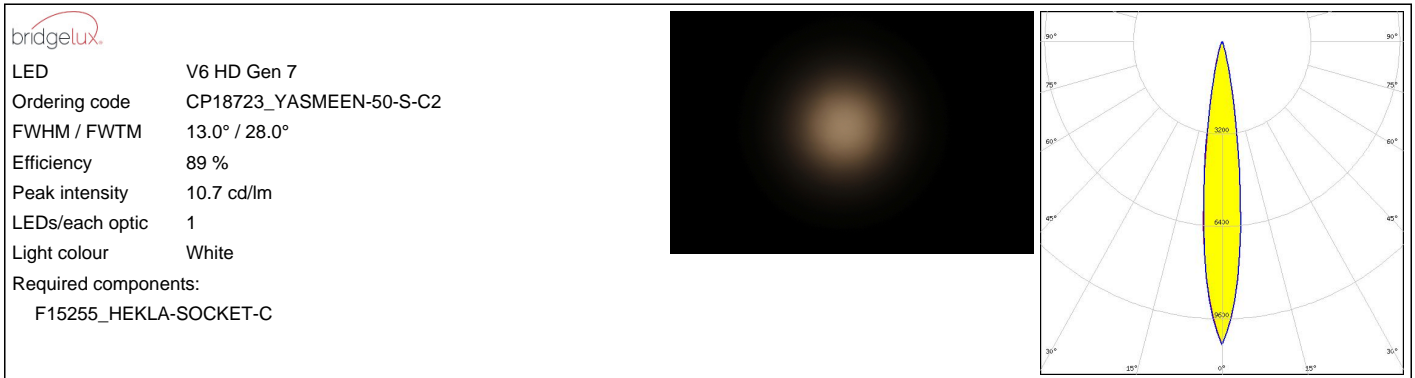
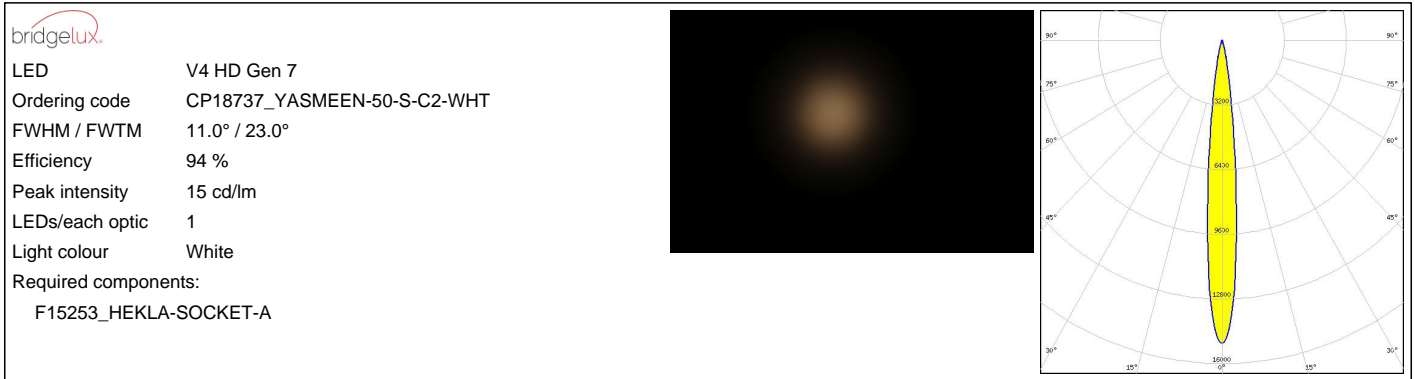

### OPTICAL RESULTS (MEASURED):

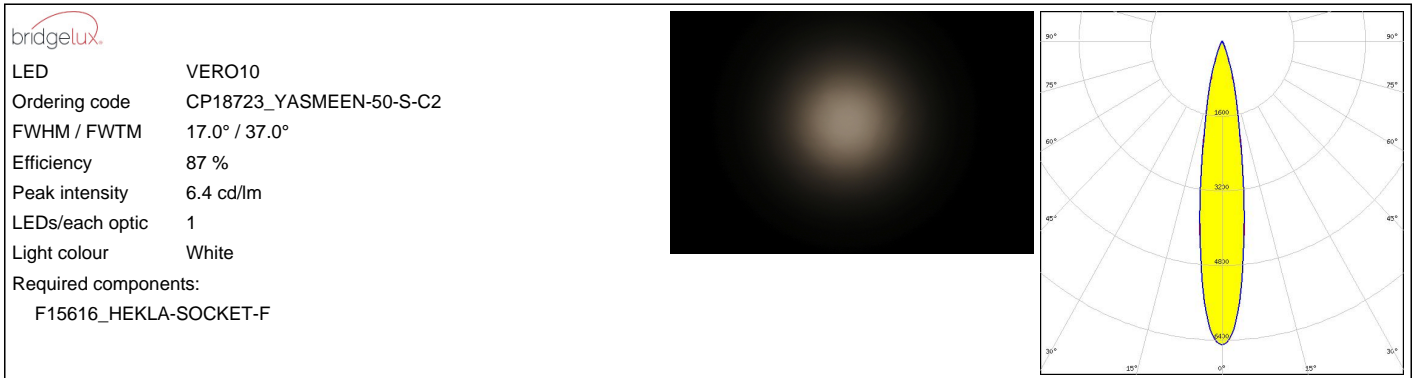

### OPTICAL RESULTS (MEASURED):



**LED** Vesta DTW 15mm (33W)  
**Ordering code** CP18737\_YASMEEN-50-S-C2-WHT  
**FWHM / FWTM** 26.0° / 56.0°  
**Efficiency** 88 %  
**Peak intensity** 2.6 cd/lm  
**LEDs/each optic** 1  
**Light colour** White  
**Required components:**  
 Bender Wirth: 632b Hekla XL

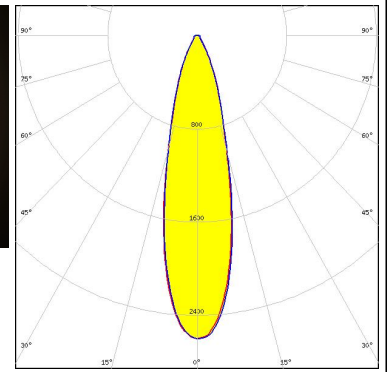
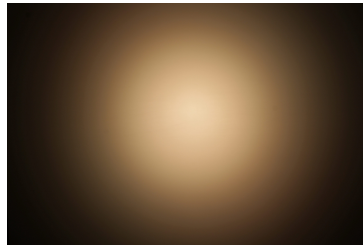

**LED** Vesta DTW 9mm (4W/6W/12W)  
**Ordering code** CP18723\_YASMEEN-50-S-C2  
**FWHM / FWTM** 18.0° / 37.0°  
**Efficiency** 86 %  
**Peak intensity** 6.5 cd/lm  
**LEDs/each optic** 1  
**Light colour** White  
**Required components:**  
 Bender Wirth: 652b Hekla

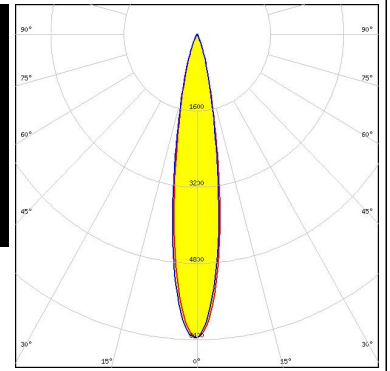

### CITIZEN

**LED** CLL02x/CLU02x (LES10)  
**Ordering code** CP18723\_YASMEEN-50-S-C2  
**FWHM / FWTM** 18.0° / 38.0°  
**Efficiency** 86 %  
**Peak intensity** 5.8 cd/lm  
**LEDs/each optic** 1  
**Light colour** White  
**Required components:**  
 F17435\_HEKLA-G2-C

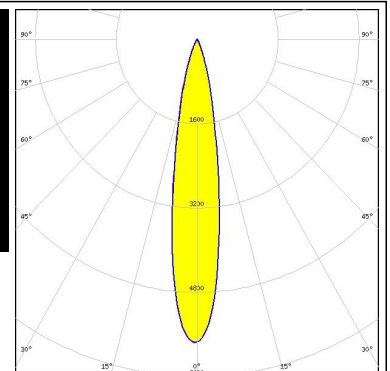
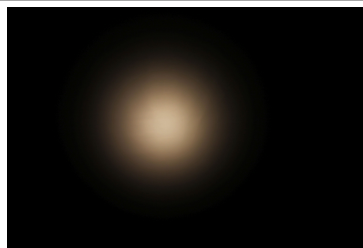

### CITIZEN

**LED** CLL02x/CLU02x (LES10)  
**Ordering code** CP18737\_YASMEEN-50-S-C2-WHT  
**FWHM / FWTM** 18.0° / 39.0°  
**Efficiency** 92 %  
**Peak intensity** 5.7 cd/lm  
**LEDs/each optic** 1  
**Light colour** White  
**Required components:**  
 F17435\_HEKLA-G2-C

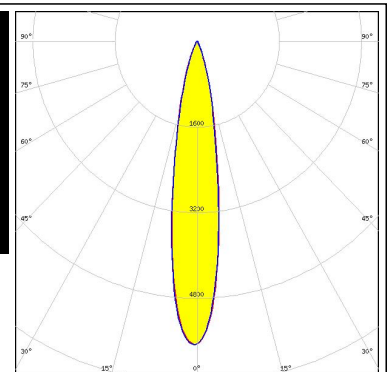

### OPTICAL RESULTS (MEASURED):

#### CITIZEN

LED CLU700/701/702/703  
 Ordering code CP18723\_YASMEEN-50-S-C2  
 FWHM / FWTM 13.0° / 27.0°  
 Efficiency 89 %  
 Peak intensity 11 cd/lm  
 LEDs/each optic 1  
 Light colour White  
 Required components:  
 F17435\_HEKLA-G2-C

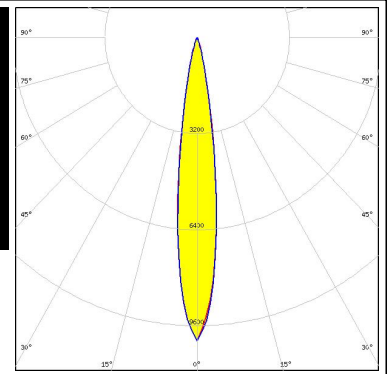

#### CITIZEN

LED CLU700/701/702/703  
 Ordering code CP18737\_YASMEEN-50-S-C2-WHT  
 FWHM / FWTM 13.0° / 27.0°  
 Efficiency 93 %  
 Peak intensity 11 cd/lm  
 LEDs/each optic 1  
 Light colour White  
 Required components:  
 F17435\_HEKLA-G2-C

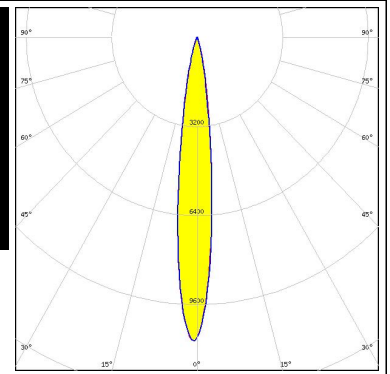
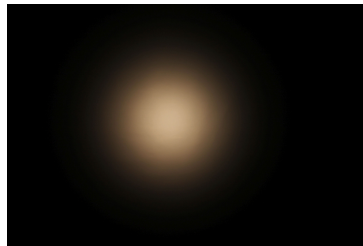

#### CITIZEN

LED CLU7A2/7A3  
 Ordering code CP18737\_YASMEEN-50-S-C2-WHT  
 FWHM / FWTM 11.0° / 23.0°  
 Efficiency 94 %  
 Peak intensity 15.1 cd/lm  
 LEDs/each optic 1  
 Light colour White  
 Required components:  
 F17435\_HEKLA-G2-C

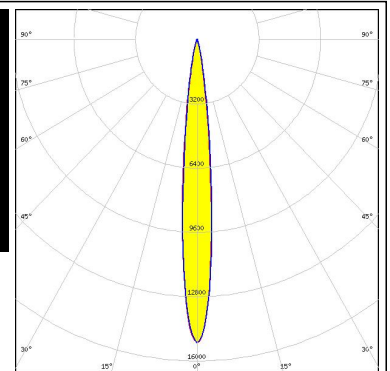

#### CITIZEN

LED CLU7A2/7A3  
 Ordering code CP18723\_YASMEEN-50-S-C2  
 FWHM / FWTM 11.0° / 23.0°  
 Efficiency 89 %  
 Peak intensity 15.1 cd/lm  
 LEDs/each optic 1  
 Light colour White  
 Required components:  
 F17435\_HEKLA-G2-C

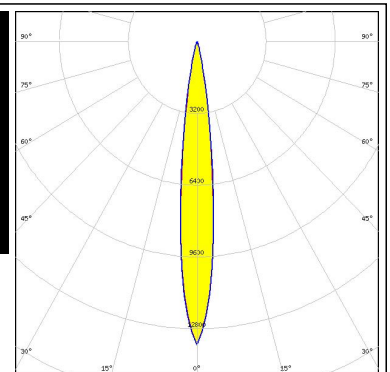
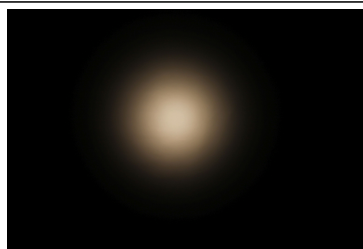



### OPTICAL RESULTS (MEASURED):

#### CITIZEN

LED CLU7B2  
 Ordering code CP18737\_YASMEEN-50-S-C2-WHT  
 FWHM / FWTM 10.0° / 21.0°  
 Efficiency 94 %  
 Peak intensity 17.8 cd/lm  
 LEDs/each optic 1  
 Light colour White  
 Required components:  
 F17435\_HEKLA-G2-C

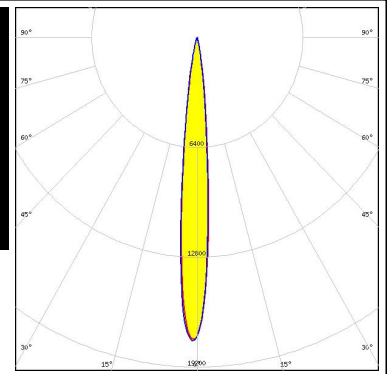
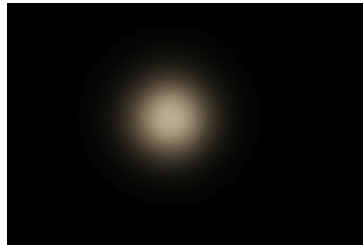

#### CITIZEN

LED CLU7B2  
 Ordering code CP18723\_YASMEEN-50-S-C2  
 FWHM / FWTM 10.0° / 21.0°  
 Efficiency 89 %  
 Peak intensity 17.8 cd/lm  
 LEDs/each optic 1  
 Light colour White  
 Required components:  
 F17435\_HEKLA-G2-C

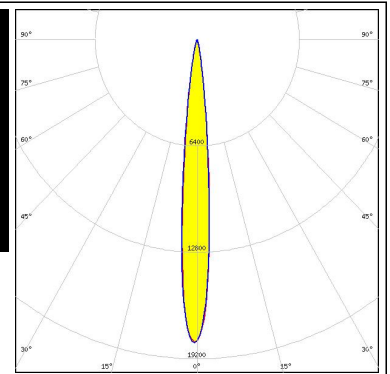
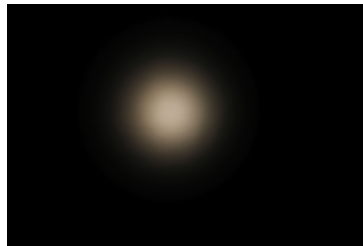

#### CREE LEDs

LED CMA1516  
 Ordering code CP18737\_YASMEEN-50-S-C2-WHT  
 FWHM / FWTM 17.0° / 37.0°  
 Efficiency 93 %  
 Peak intensity 6.2 cd/lm  
 LEDs/each optic 1  
 Light colour White  
 Required components:  
 F17436\_HEKLA-G2-D

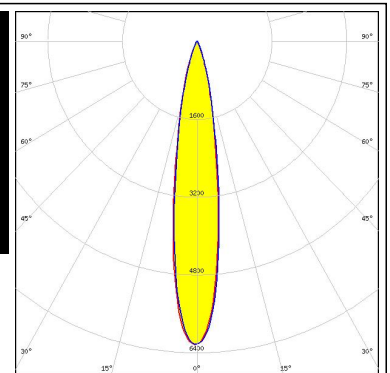
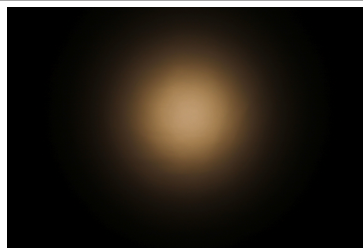

#### CREE LEDs

LED CMA1516  
 Ordering code CP18723\_YASMEEN-50-S-C2  
 FWHM / FWTM 17.0° / 36.0°  
 Efficiency 87 %  
 Peak intensity 6.3 cd/lm  
 LEDs/each optic 1  
 Light colour White  
 Required components:  
 F17436\_HEKLA-G2-D

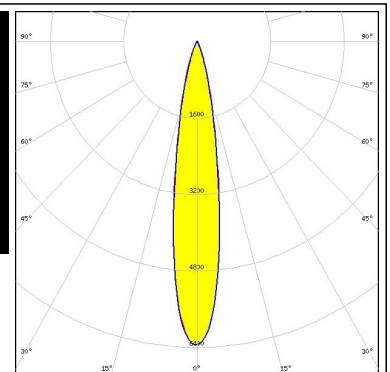
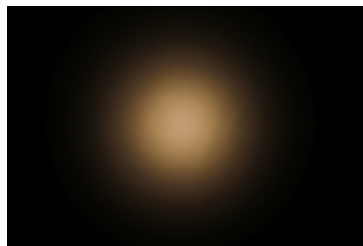

### OPTICAL RESULTS (MEASURED):



**LED** CMT14xx  
**Ordering code** CP18737\_YASMEEN-50-S-C2-WHT  
**FWHM / FWTM** 18.0° / 38.0°  
**Efficiency** 92 %  
**Peak intensity** 5.8 cd/lm  
**LEDs/each optic** 1  
**Light colour** White  
**Required components:**  
 F17435\_HEKLA-G2-C

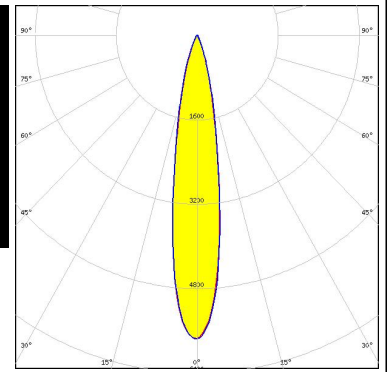

**LED** CMT14xx  
**Ordering code** CP18723\_YASMEEN-50-S-C2  
**FWHM / FWTM** 18.0° / 38.0°  
**Efficiency** 86 %  
**Peak intensity** 5.8 cd/lm  
**LEDs/each optic** 1  
**Light colour** White  
**Required components:**  
 F17435\_HEKLA-G2-C

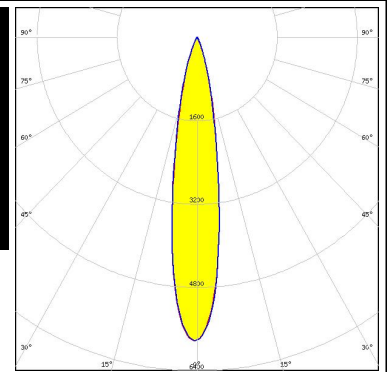

**LED** CMU10xx  
**Ordering code** CP18723\_YASMEEN-50-S-C2  
**FWHM / FWTM** 18.0° / 39.0°  
**Efficiency** 84 %  
**Peak intensity** 5.7 cd/lm  
**LEDs/each optic** 1  
**Light colour** White  
**Required components:**  
 F17435\_HEKLA-G2-C

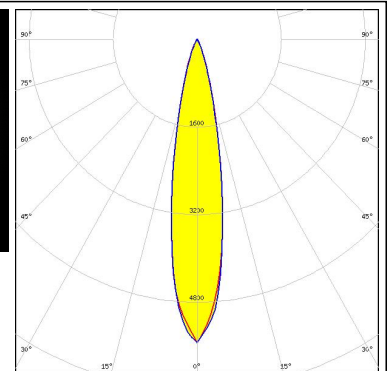
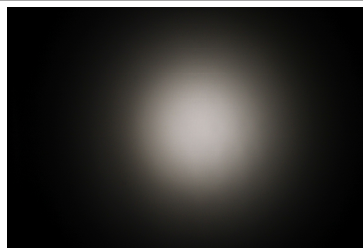

**LED** CXA/B 13xx  
**Ordering code** CP18723\_YASMEEN-50-S-C2  
**FWHM / FWTM** 12.0° / 26.0°  
**Efficiency** 89 %  
**Peak intensity** 12.5 cd/lm  
**LEDs/each optic** 1  
**Light colour** White  
**Required components:**  
 F17439\_HEKLA-G2-J

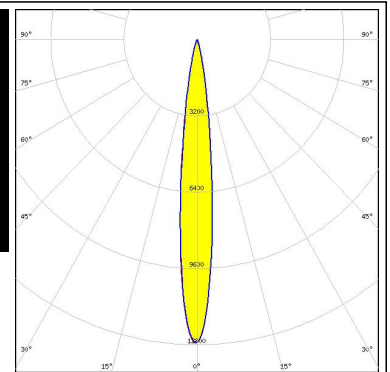
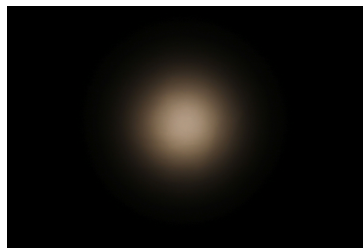

### OPTICAL RESULTS (MEASURED):



LED CXA/B 13xx  
 Ordering code CP18737\_YASMEEN-50-S-C2-WHT  
 FWHM / FWTM 12.0° / 26.0°  
 Efficiency 94 %  
 Peak intensity 12.5 cd/lm  
 LEDs/each optic 1  
 Light colour White  
 Required components:  
 F17439\_HEKLA-G2-J

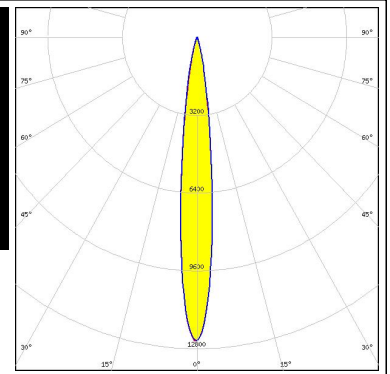
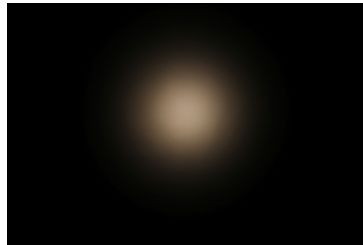

LED CXA/B 15xx  
 Ordering code CP18737\_YASMEEN-50-S-C2-WHT  
 FWHM / FWTM 16.0° / 34.0°  
 Efficiency 93 %  
 Peak intensity 7.3 cd/lm  
 LEDs/each optic 1  
 Light colour White  
 Required components:  
 F17436\_HEKLA-G2-D

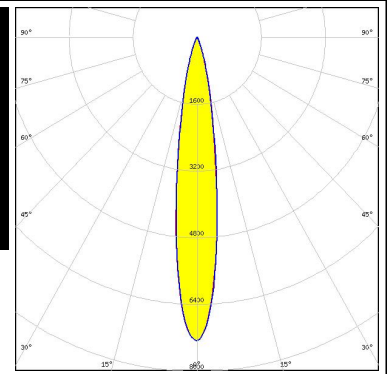

LED CXA/B 15xx  
 Ordering code CP18723\_YASMEEN-50-S-C2  
 FWHM / FWTM 15.0° / 34.0°  
 Efficiency 87 %  
 Peak intensity 7.3 cd/lm  
 LEDs/each optic 1  
 Light colour White  
 Required components:  
 F17436\_HEKLA-G2-D

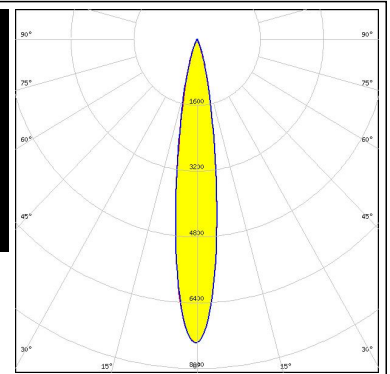
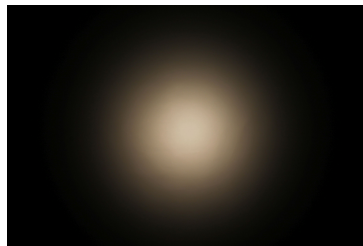

LED LEDiM/C6  
 Ordering code CP18723\_YASMEEN-50-S-C2  
 FWHM / FWTM 20.0° / 38.0°  
 Efficiency 86 %  
 Peak intensity 5.4 cd/lm  
 LEDs/each optic 1  
 Light colour White  
 Required components:  
 F17438\_HEKLA-G2-I

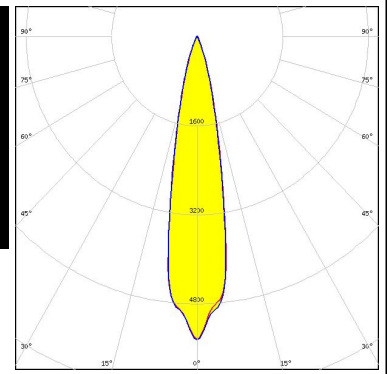

### OPTICAL RESULTS (MEASURED):

#### LUMILEDS

LED LUXEON CoB 1202/1203  
Ordering code CP18737\_YASMEEN-50-S-C2-WHT  
FWHM / FWTM 17.0° / 37.0°  
Efficiency 92 %  
Peak intensity 6.5 cd/lm  
LEDs/each optic 1  
Light colour White  
Required components:  
F17437\_HEKLA-G2-H

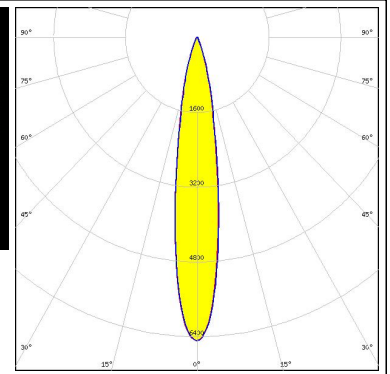

#### LUMILEDS

LED LUXEON CoB 1202/1203  
Ordering code CP18723\_YASMEEN-50-S-C2  
FWHM / FWTM 17.0° / 36.0°  
Efficiency 86 %  
Peak intensity 6.6 cd/lm  
LEDs/each optic 1  
Light colour White  
Required components:  
F17437\_HEKLA-G2-H

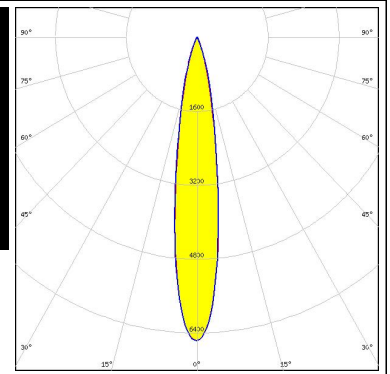

#### LUMILEDS

LED LUXEON CoB 1204HD  
Ordering code CP18737\_YASMEEN-50-S-C2-WHT  
FWHM / FWTM 17.0° / 37.0°  
Efficiency 93 %  
Peak intensity 6.3 cd/lm  
LEDs/each optic 1  
Light colour White  
Required components:  
F17437\_HEKLA-G2-H

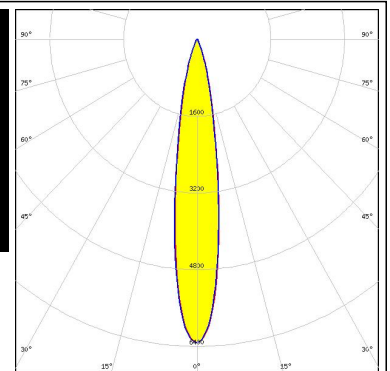

#### LUMILEDS

LED LUXEON CoB 1204HD  
Ordering code CP18723\_YASMEEN-50-S-C2  
FWHM / FWTM 17.0° / 36.0°  
Efficiency 86 %  
Peak intensity 6.4 cd/lm  
LEDs/each optic 1  
Light colour White  
Required components:  
F17437\_HEKLA-G2-H

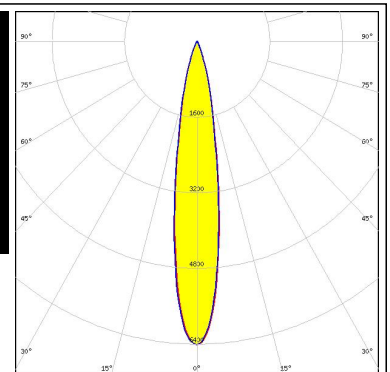

### OPTICAL RESULTS (MEASURED):

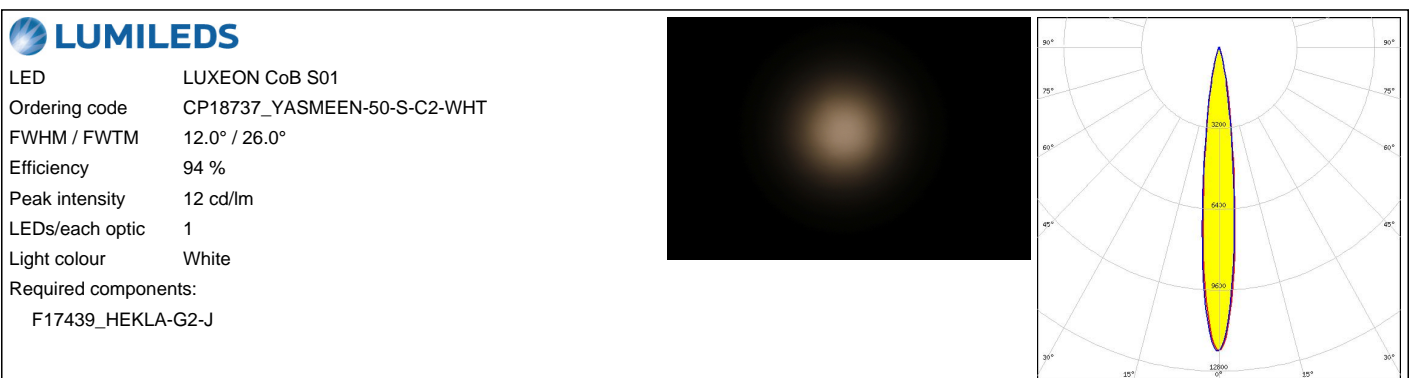
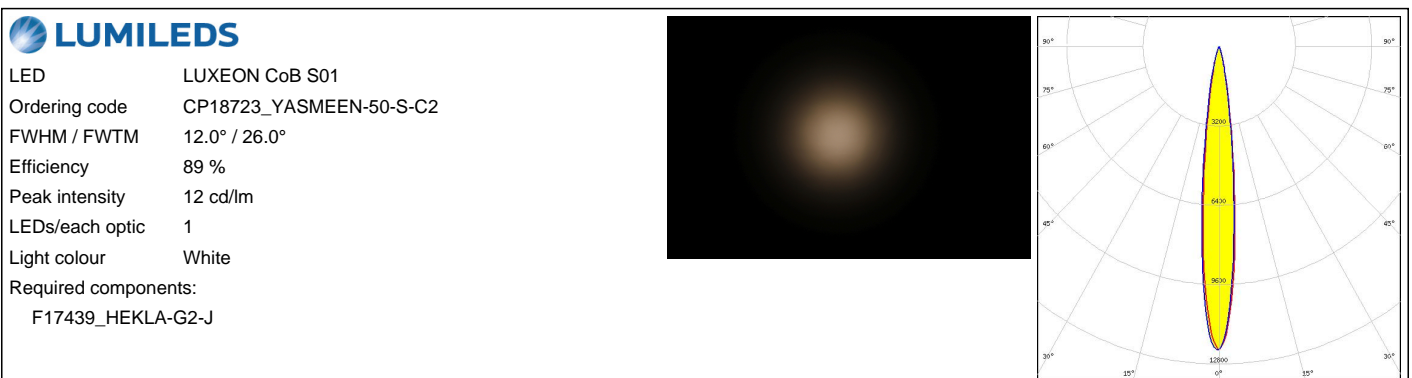

### OPTICAL RESULTS (MEASURED):



**LED** CTM-14 (Tunable White) Gen2  
**Ordering code** CP18723\_YASMEEN-50-S-C2  
**FWHM / FWTM** 24.0° / 54.0°  
**Efficiency** 74 %  
**Peak intensity** 2.7 cd/lm  
**LEDs/each optic** 1  
**Light colour** Tunable White  
**Required components:**  
 C16142\_HEKLA-SOCKET-K  
 Bender Wirth: 442 Typ L8

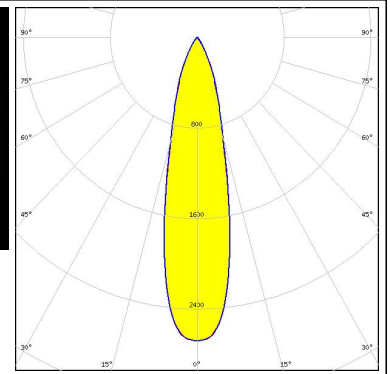

**LED** CXM-3  
**Ordering code** CP18737\_YASMEEN-50-S-C2-WHT  
**FWHM / FWTM** 10.0° / 21.0°  
**Efficiency** 94 %  
**Peak intensity** 17.7 cd/lm  
**LEDs/each optic** 1  
**Light colour** White  
**Required components:**  
 F17435\_HEKLA-G2-C

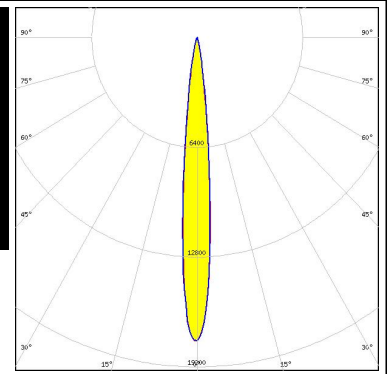
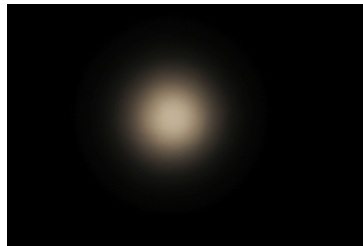

**LED** CXM-3  
**Ordering code** CP18723\_YASMEEN-50-S-C2  
**FWHM / FWTM** 11.0° / 21.0°  
**Efficiency** 89 %  
**Peak intensity** 17.7 cd/lm  
**LEDs/each optic** 1  
**Light colour** White  
**Required components:**  
 F17435\_HEKLA-G2-C

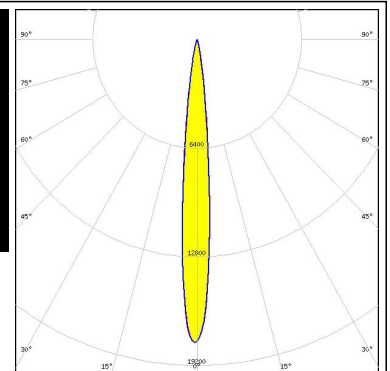

**LED** CXM-4  
**Ordering code** CP18737\_YASMEEN-50-S-C2-WHT  
**FWHM / FWTM** 11.0° / 24.0°  
**Efficiency** 94 %  
**Peak intensity** 14.4 cd/lm  
**LEDs/each optic** 1  
**Light colour** White  
**Required components:**  
 F17435\_HEKLA-G2-C

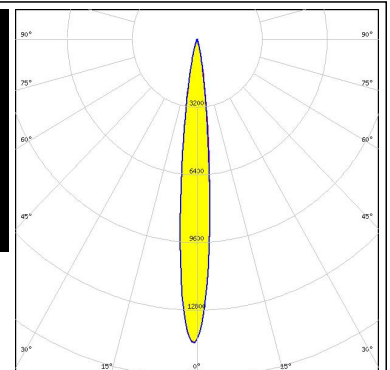

### OPTICAL RESULTS (MEASURED):



**LED** CXM-4  
**Ordering code** CP18723\_YASMEEN-50-S-C2  
**FWHM / FWTM** 12.0° / 24.0°  
**Efficiency** 89 %  
**Peak intensity** 14.4 cd/lm  
**LEDs/each optic** 1  
**Light colour** White  
**Required components:**  
 F17435\_HEKLA-G2-C

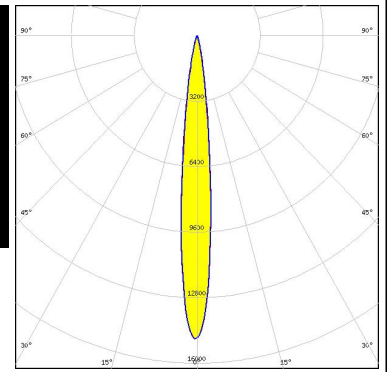
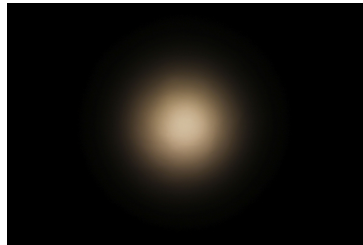

**LED** COB L-Type (LES 9)  
**Ordering code** CP18737\_YASMEEN-50-S-C2-WHT  
**FWHM / FWTM** 16.0° / 35.0°  
**Efficiency** 92 %  
**Peak intensity** 7 cd/lm  
**LEDs/each optic** 1  
**Light colour** White  
**Required components:**  
 F17437\_HEKLA-G2-H

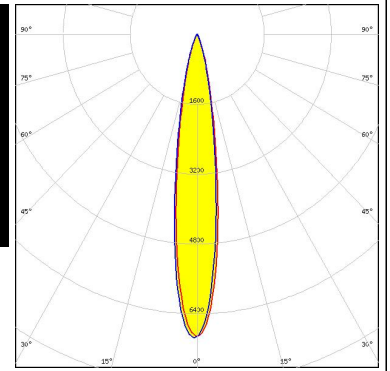
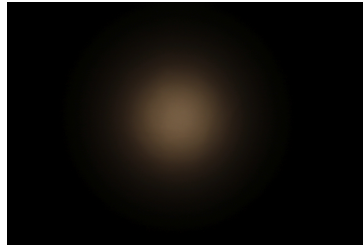

**LED** COB S-Type (LES 7)  
**Ordering code** CP18737\_YASMEEN-50-S-C2-WHT  
**FWHM / FWTM** 14.0° / 29.0°  
**Efficiency** 93 %  
**Peak intensity** 10.1 cd/lm  
**LEDs/each optic** 1  
**Light colour** White  
**Required components:**  
 F15848\_HEKLA-SOCKET-G

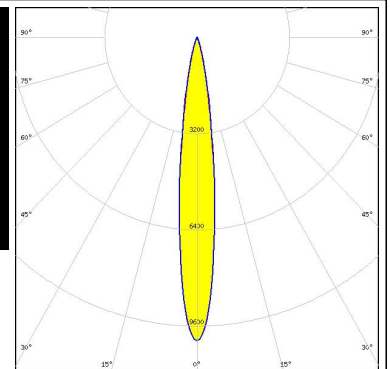

**LED** Fortimo SLM L09 CoB  
**Ordering code** CP18723\_YASMEEN-50-S-C2  
**FWHM / FWTM** 16.0° / 36.0°  
**Efficiency** 86 %  
**Peak intensity** 6.5 cd/lm  
**LEDs/each optic** 1  
**Light colour** White  
**Required components:**  
 F17437\_HEKLA-G2-H

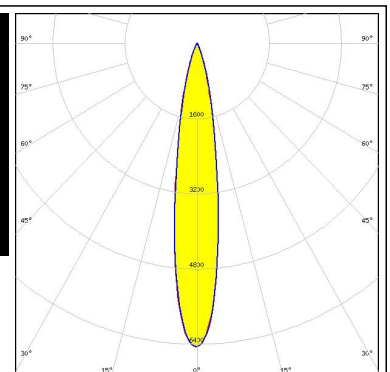
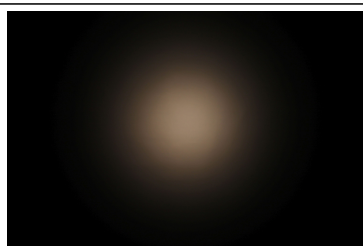

### OPTICAL RESULTS (MEASURED):

#### PHILIPS

LED Fortimo SLM L09 CoB  
 Ordering code CP18737\_YASMEEN-50-S-C2-WHT  
 FWHM / FWTM 17.0° / 37.0°  
 Efficiency 92 %  
 Peak intensity 6.4 cd/lm  
 LEDs/each optic 1  
 Light colour White  
 Required components:  
 F17437\_HEKLA-G2-H

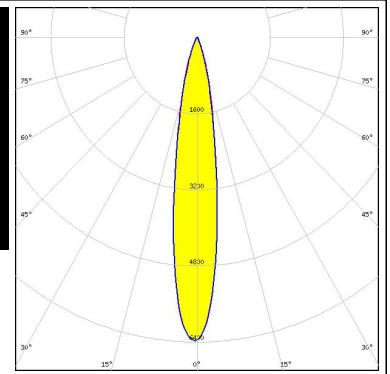

#### SAMSUNG

LED LC003D / LC006D / LC009D / LC013D  
 Ordering code CP18737\_YASMEEN-50-S-C2-WHT  
 FWHM / FWTM 17.0° / 38.0°  
 Efficiency 92 %  
 Peak intensity 5.8 cd/lm  
 LEDs/each optic 1  
 Light colour White  
 Required components:  
 F17435\_HEKLA-G2-C

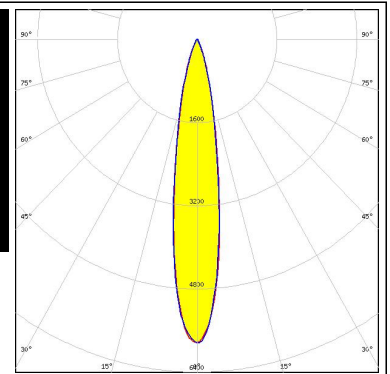

#### SAMSUNG

LED LC003D / LC006D / LC009D / LC013D  
 Ordering code CP18723\_YASMEEN-50-S-C2  
 FWHM / FWTM 17.0° / 38.0°  
 Efficiency 86 %  
 Peak intensity 5.8 cd/lm  
 LEDs/each optic 1  
 Light colour White  
 Required components:  
 F17435\_HEKLA-G2-C

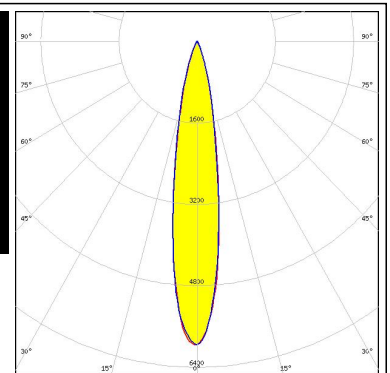
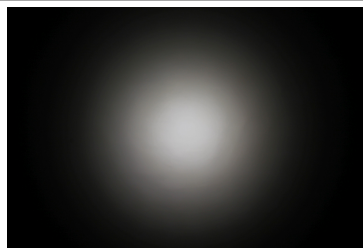

LED MJT COB LES 6  
 Ordering code CP18737\_YASMEEN-50-S-C2-WHT  
 FWHM / FWTM 12.0° / 27.0°  
 Efficiency 94 %  
 Peak intensity 11.7 cd/lm  
 LEDs/each optic 1  
 Light colour White  
 Required components:  
 F17435\_HEKLA-G2-C

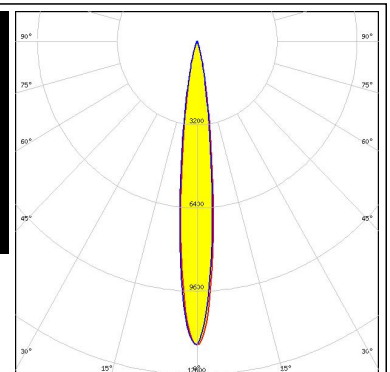
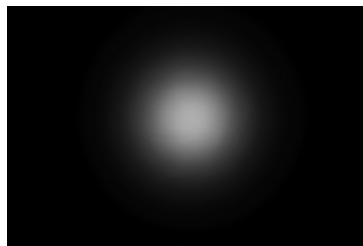



### OPTICAL RESULTS (MEASURED):

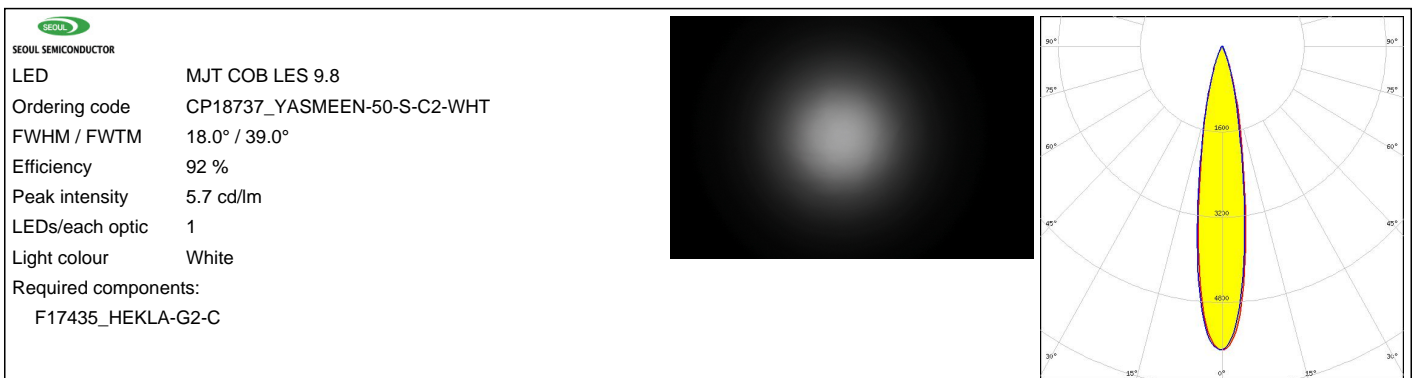
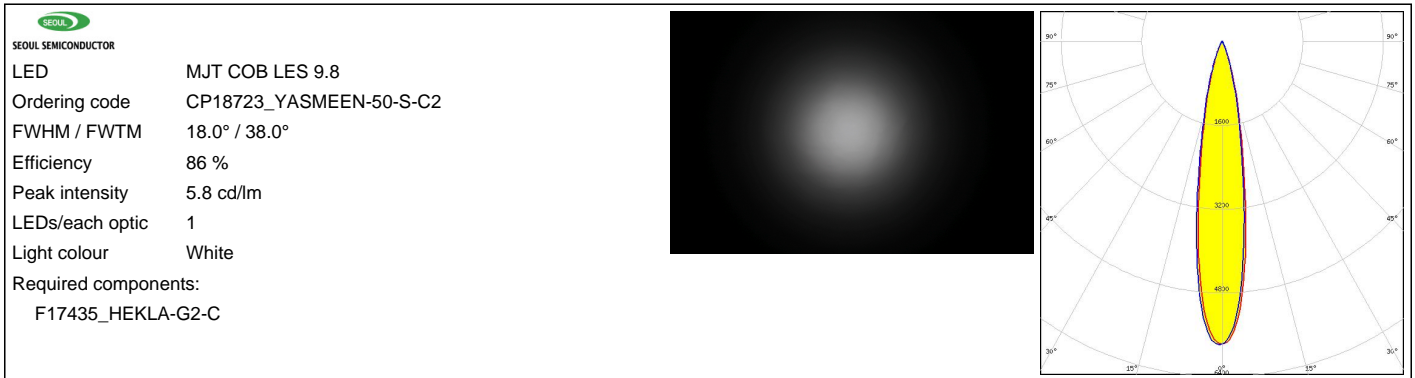
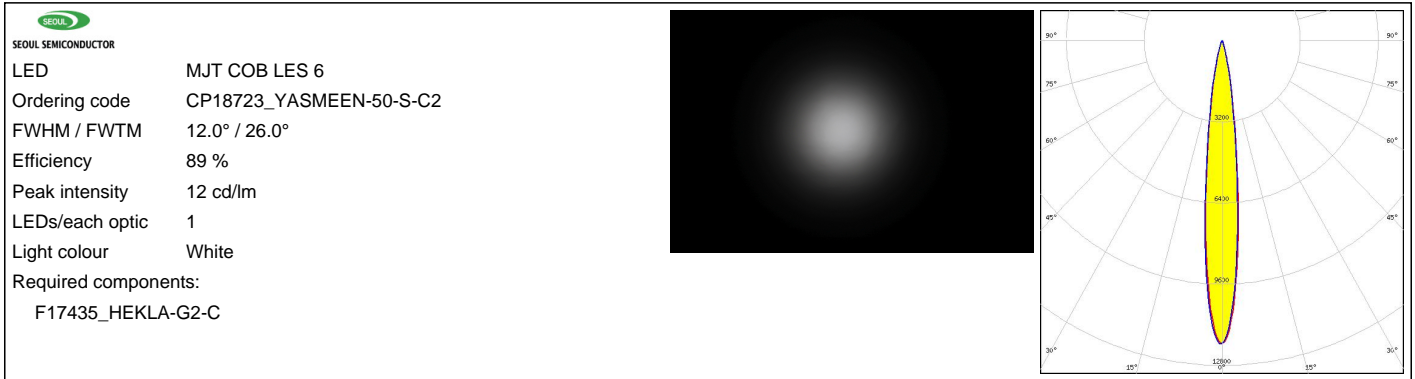

### OPTICAL RESULTS (SIMULATED):

bridgelux

LED V3 HD Gen 8  
 Ordering code CP18723\_YASMEEN-50-S-C2  
 FWHM / FWTM 12.0° / 22.0°  
 Efficiency 90 %  
 Peak intensity 16.2 cd/lm  
 LEDs/each optic 1  
 Light colour White  
 Required components:  
 F15253\_HEKLA-SOCKET-A

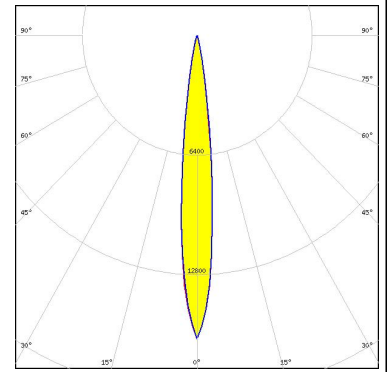

bridgelux

LED V3 HD Gen 8 FC  
 Ordering code CP18723\_YASMEEN-50-S-C2  
 FWHM / FWTM 12.0° / 22.0°  
 Efficiency 91 %  
 Peak intensity 18.1 cd/lm  
 LEDs/each optic 1  
 Light colour White  
 Required components:  
 F15255\_HEKLA-SOCKET-C

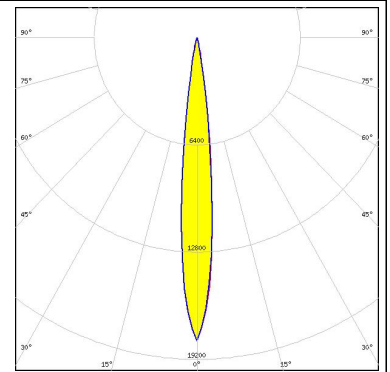

bridgelux

LED V4 HD Gen 8  
 Ordering code CP18723\_YASMEEN-50-S-C2  
 FWHM / FWTM 12.0° / 24.0°  
 Efficiency 90 %  
 Peak intensity 14.3 cd/lm  
 LEDs/each optic 1  
 Light colour White  
 Required components:  
 F15253\_HEKLA-SOCKET-A

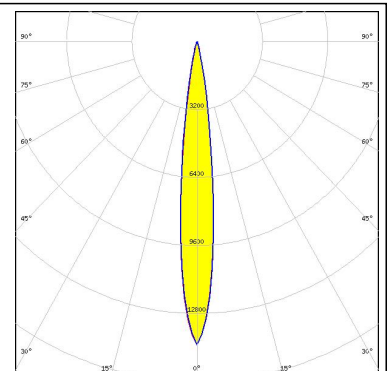

bridgelux

LED V6 Gen 8-9  
 Ordering code CP18723\_YASMEEN-50-S-C2  
 FWHM / FWTM 14.0° / 28.0°  
 Efficiency 89 %  
 Peak intensity 10.7 cd/lm  
 LEDs/each optic 1  
 Light colour White  
 Required components:  
 F15253\_HEKLA-SOCKET-A

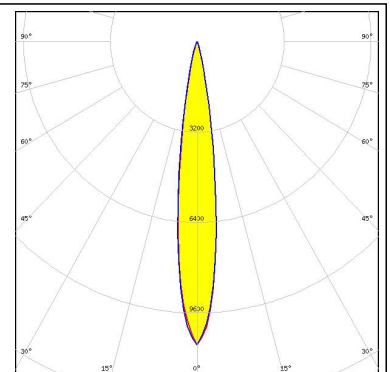

### OPTICAL RESULTS (SIMULATED):



**LED** V6 HD Gen 7  
**Ordering code** CP18723\_YASMEEN-50-S-C2  
**FWHM / FWTM** 14.0° / 28.0°  
**Efficiency** 89 %  
**Peak intensity** 10.5 cd/lm  
**LEDs/each optic** 1  
**Light colour** White  
**Required components:**  
 F17435\_HEKLA-G2-C

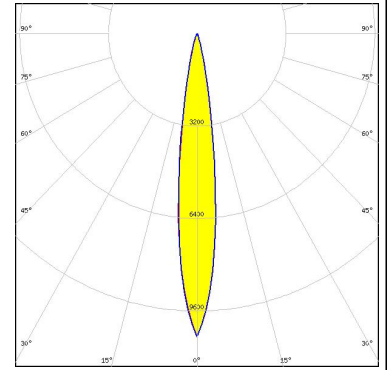

**LED** V6 HD Gen 8  
**Ordering code** CP18723\_YASMEEN-50-S-C2  
**FWHM / FWTM** 14.0° / 28.0°  
**Efficiency** 90 %  
**Peak intensity** 10.4 cd/lm  
**LEDs/each optic** 1  
**Light colour** White  
**Required components:**  
 F15255\_HEKLA-SOCKET-C

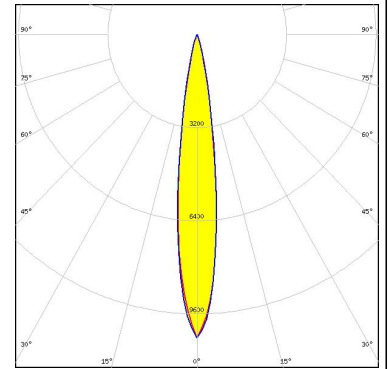

**LED** V9 HD Gen 8  
**Ordering code** CP18723\_YASMEEN-50-S-C2  
**FWHM / FWTM** 18.0° / 34.0°  
**Efficiency** 89 %  
**Peak intensity** 7.5 cd/lm  
**LEDs/each optic** 1  
**Light colour** White  
**Required components:**  
 F15859\_HEKLA-SOCKET-I

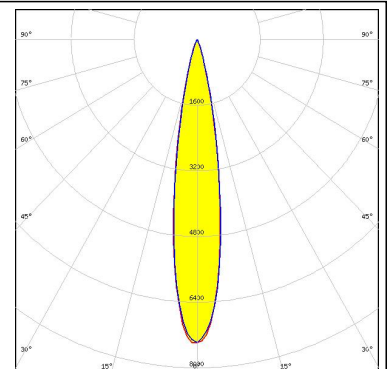

**LED** Vero SE 13  
**Ordering code** CP18723\_YASMEEN-50-S-C2  
**FWHM / FWTM** 20.0° / 50.0°  
**Efficiency** 68 %  
**Peak intensity** 3 cd/lm  
**LEDs/each optic** 1  
**Light colour** White  
**Required components:**  
 C16142\_HEKLA-SOCKET-K

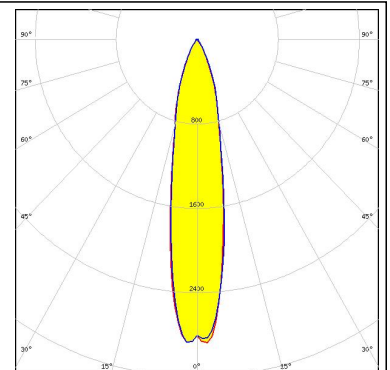

### OPTICAL RESULTS (SIMULATED):

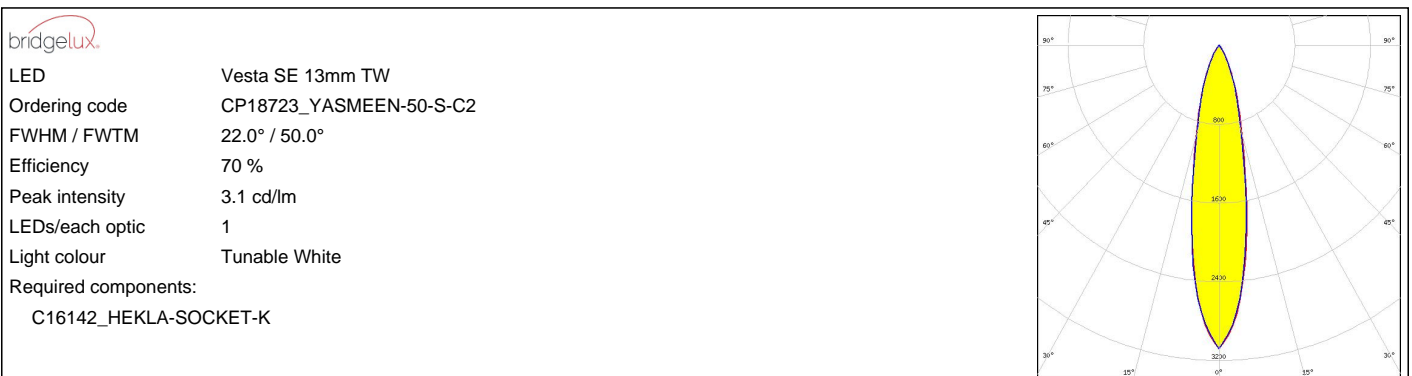
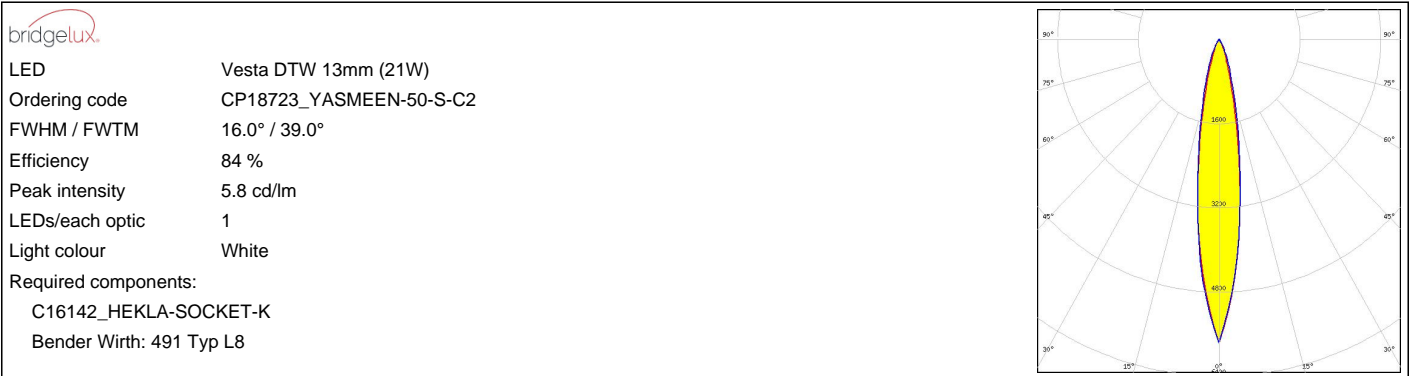

### OPTICAL RESULTS (SIMULATED):



**LED** Vesta TW 13mm (18W) DP  
**Ordering code** CP18723\_YASMEEN-50-S-C2  
**FWHM / FWTM** 24.0° / 50.0°  
**Efficiency** 77 %  
**Peak intensity** 3.3 cd/lm  
**LEDs/each optic** 1  
**Light colour** Tunable White  
**Required components:**  
 C16142\_HEKLA-SOCKET-K  
 Bender Wirth: 492 Typ L8

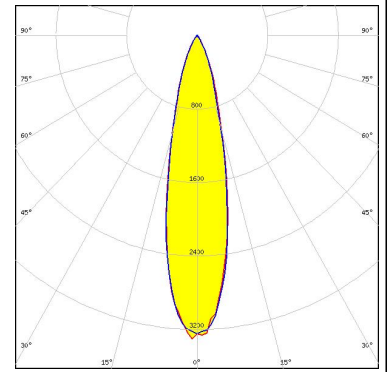

**LED** Vesta TW 15mm DP  
**Ordering code** CP18723\_YASMEEN-50-S-C2  
**FWHM / FWTM** 28.0° / 56.0°  
**Efficiency** 73 %  
**Peak intensity** 2.4 cd/lm  
**LEDs/each optic** 1  
**Light colour** Tunable White  
**Required components:**  
 C16142\_HEKLA-SOCKET-K  
 Bender Wirth: 482 Typ L8

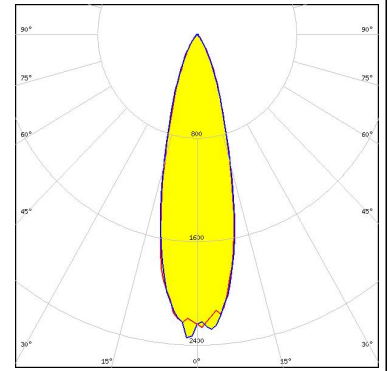

**LED** Vesta TW 9mm (9W) DP  
**Ordering code** CP18723\_YASMEEN-50-S-C2  
**FWHM / FWTM** 22.0° / 38.0°  
**Efficiency** 91 %  
**Peak intensity** 5.7 cd/lm  
**LEDs/each optic** 1  
**Light colour** Tunable White  
**Required components:**  
 C16142\_HEKLA-SOCKET-K  
 Bender Wirth: 489 Typ L8

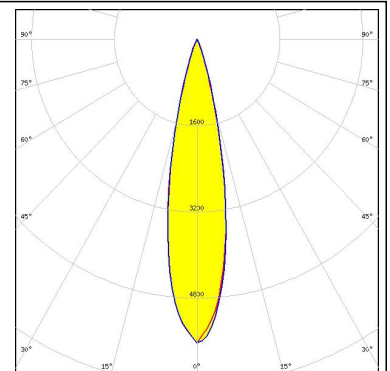

### CITIZEN

**LED** CLU712/713  
**Ordering code** CP18723\_YASMEEN-50-S-C2  
**FWHM / FWTM** 18.0° / 36.0°  
**Efficiency** 88 %  
**Peak intensity** 6.7 cd/lm  
**LEDs/each optic** 1  
**Light colour** White  
**Required components:**  
 F17438\_HEKLA-G2-I

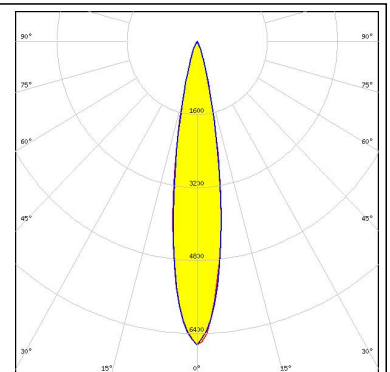

### OPTICAL RESULTS (SIMULATED):

#### CITIZEN

LED CLU7A2/7A3  
 Ordering code CP18723\_YASMEEN-50-S-C2  
 FWHM / FWTM 12.0° / 24.0°  
 Efficiency 90 %  
 Peak intensity 13.5 cd/lm  
 LEDs/each optic 1  
 Light colour White  
 Required components:  
 F15255\_HEKLA-SOCKET-C

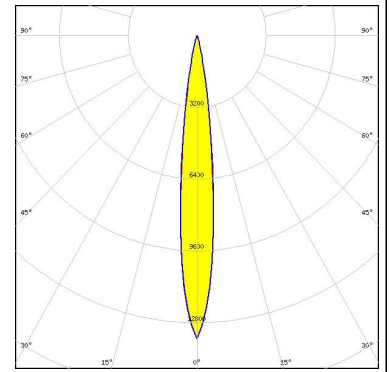

#### CITIZEN

LED CLU7B2  
 Ordering code CP18730\_YASMEEN-50-S-B2  
 FWHM / FWTM 12.0° / 22.0°  
 Efficiency 90 %  
 Peak intensity 15.8 cd/lm  
 LEDs/each optic 1  
 Light colour White  
 Required components:  
 BJB: 47.360.1020

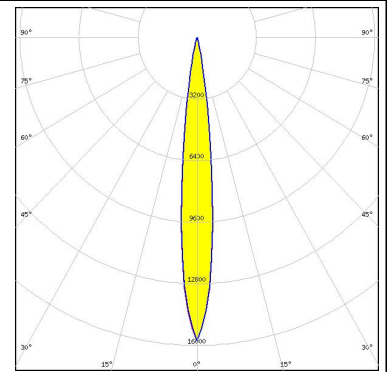

LED CHA0304  
 Ordering code CP18723\_YASMEEN-50-S-C2  
 FWHM / FWTM 12.0° / 22.0°  
 Efficiency 90 %  
 Peak intensity 17.5 cd/lm  
 LEDs/each optic 1  
 Light colour White  
 Required components:  
 F17435\_HEKLA-G2-C

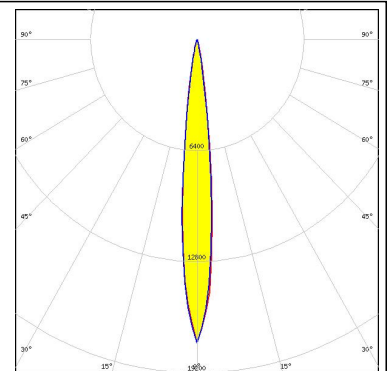

LED CHA0410  
 Ordering code CP18723\_YASMEEN-50-S-C2  
 FWHM / FWTM 13.0° / 25.0°  
 Efficiency 91 %  
 Peak intensity 13.6 cd/lm  
 LEDs/each optic 1  
 Light colour White  
 Required components:  
 F17435\_HEKLA-G2-C

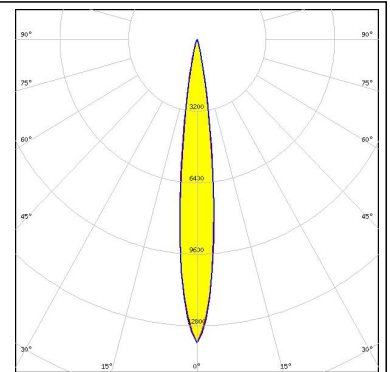

### OPTICAL RESULTS (SIMULATED):



**LED** CHA0612  
**Ordering code** CP18723\_YASMEEN-50-S-C2  
**FWHM / FWTM** 14.0° / 28.0°  
**Efficiency** 90 %  
**Peak intensity** 10.7 cd/lm  
**LEDs/each optic** 1  
**Light colour** White  
**Required components:**  
 F17435\_HEKLA-G2-C

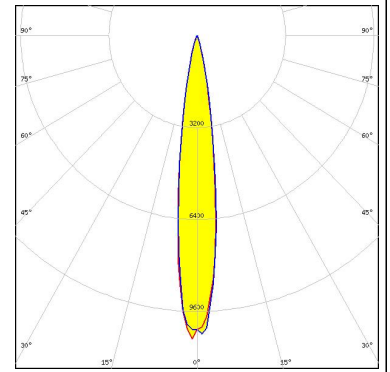

**LED** CHA0825  
**Ordering code** CP18723\_YASMEEN-50-S-C2  
**FWHM / FWTM** 18.0° / 36.0°  
**Efficiency** 88 %  
**Peak intensity** 6.9 cd/lm  
**LEDs/each optic** 1  
**Light colour** White  
**Required components:**  
 F17438\_HEKLA-G2-I

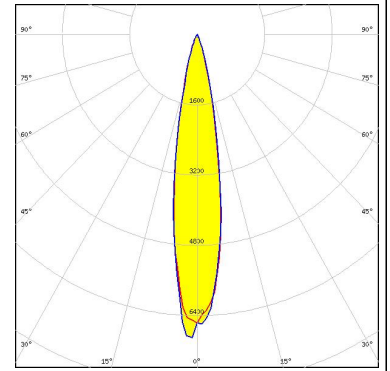

**LED** CMA1306  
**Ordering code** CP18723\_YASMEEN-50-S-C2  
**FWHM / FWTM** 14.0° / 30.0°  
**Efficiency** 89 %  
**Peak intensity** 10.1 cd/lm  
**LEDs/each optic** 1  
**Light colour** White  
**Required components:**  
 F17439\_HEKLA-G2-J

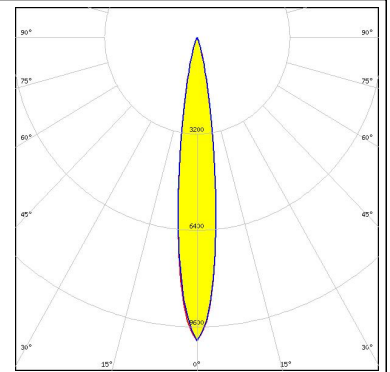

**LED** LUXEON CX Plus CoB L08 (Gen2)  
**Ordering code** CP18723\_YASMEEN-50-S-C2  
**FWHM / FWTM** 28.0° / 54.0°  
**Efficiency** 79 %  
**Peak intensity** 2.7 cd/lm  
**LEDs/each optic** 1  
**Light colour** White  
**Required components:**  
 Bender Wirth: 637a Hekla

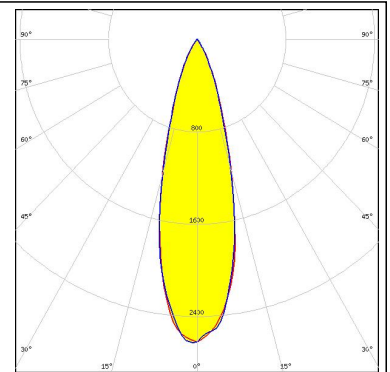

### OPTICAL RESULTS (SIMULATED):

#### LUMILEDS

LED LUXEON 7070  
FWHM / FWTM 15.0° / 30.0°  
Efficiency 95 %  
Peak intensity 8.9 cd/lm  
LEDs/each optic 1  
Light colour White  
Required components:

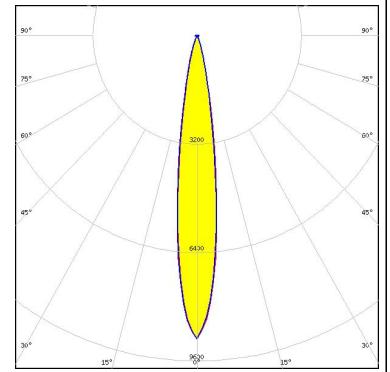

#### LUMILEDS

LED LUXEON CoB 1202/1203  
Ordering code CP18723\_YASMEEN-50-S-C2  
FWHM / FWTM 18.0° / 36.0°  
Efficiency 88 %  
Peak intensity 6.4 cd/lm  
LEDs/each optic 1  
Light colour White  
Required components:  
F15858\_HEKLA-SOCKET-H

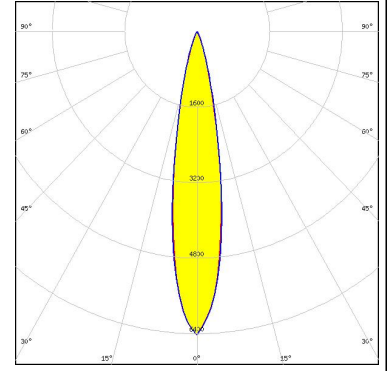

#### LUMILEDS

LED LUXEON CoB 1202HD  
Ordering code CP18723\_YASMEEN-50-S-C2  
FWHM / FWTM 16.0° / 30.0°  
Efficiency 89 %  
Peak intensity 9.5 cd/lm  
LEDs/each optic 1  
Light colour White  
Required components:  
F15848\_HEKLA-SOCKET-G

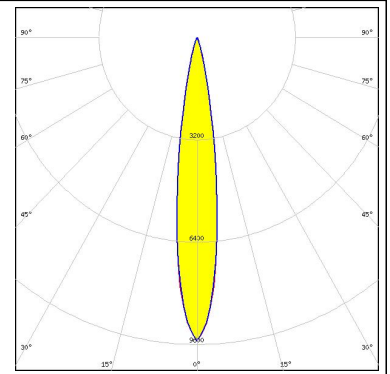

#### LUMILEDS

LED LUXEON CoB 1204/1205  
Ordering code CP18723\_YASMEEN-50-S-C2  
FWHM / FWTM 26.0° / 50.0°  
Efficiency 81 %  
Peak intensity 3.3 cd/lm  
LEDs/each optic 1  
Light colour White  
Required components:  
Bender Wirth: 632a Hekla XL

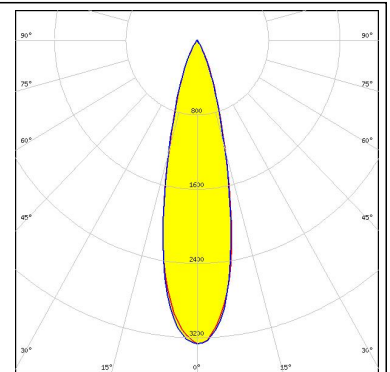



### OPTICAL RESULTS (SIMULATED):

#### LUMILEDS

LED LUXEON CoB 1205HD  
 Ordering code CP18723\_YASMEEN-50-S-C2  
 FWHM / FWTM 24.0° / 44.0°  
 Efficiency 85 %  
 Peak intensity 4.3 cd/lm  
 LEDs/each optic 1  
 Light colour White  
 Required components:  
 F15858\_HEKLA-SOCKET-H

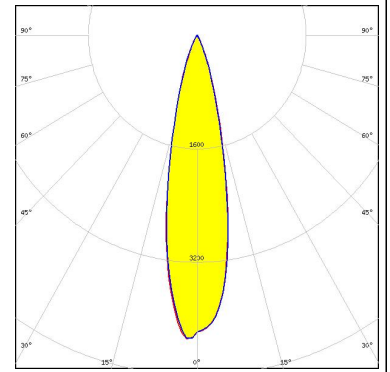

#### LUMILEDS

LED LUXEON CoB 1208  
 Ordering code CP18723\_YASMEEN-50-S-C2  
 FWHM / FWTM 28.0° / 54.0°  
 Efficiency 78 %  
 Peak intensity 2.7 cd/lm  
 LEDs/each optic 1  
 Light colour White  
 Required components:  
 Bender Wirth: 632a Hekla XL

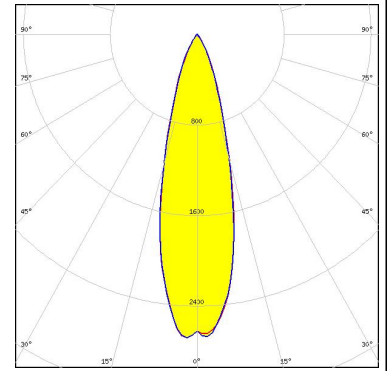

#### LUMILEDS

LED LUXEON CX Plus CoB - HD S01H4  
 Ordering code CP18730\_YASMEEN-50-S-B2  
 FWHM / FWTM 14.0° / 26.0°  
 Efficiency 90 %  
 Peak intensity 13.3 cd/lm  
 LEDs/each optic 1  
 Light colour White  
 Required components:  
 Bender Wirth: 634c Bayonet35L

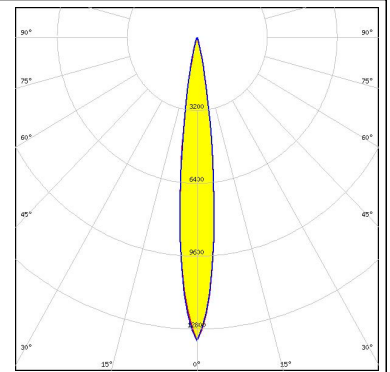

#### LUMILEDS

LED LUXEON CX Plus CoB - HD S02H6  
 Ordering code CP18730\_YASMEEN-50-S-B2  
 FWHM / FWTM 16.0° / 30.0°  
 Efficiency 90 %  
 Peak intensity 9.6 cd/lm  
 LEDs/each optic 1  
 Light colour White  
 Required components:  
 Bender Wirth: 634c Bayonet35L

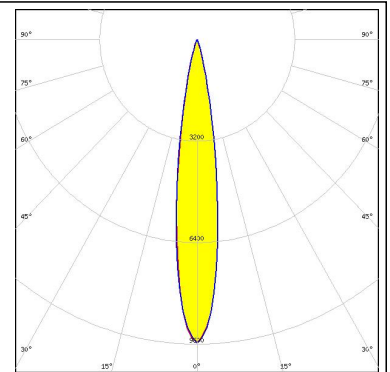

### OPTICAL RESULTS (SIMULATED):

#### LUMILEDS

LED LUXEON CX Plus CoB - HD S04H9  
 Ordering code CP18730\_YASMEEN-50-S-B2  
 FWHM / FWTM 20.0° / 38.0°  
 Efficiency 89 %  
 Peak intensity 5.8 cd/lm  
 LEDs/each optic 1  
 Light colour White  
 Required components:  
 Bender Wirth: 634a Bayonet35L

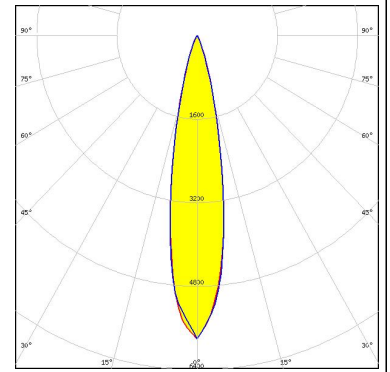

#### LUMILEDS

LED LUXEON CX Plus CoB L04 / L05 (Gen2)  
 Ordering code CP18723\_YASMEEN-50-S-C2  
 FWHM / FWTM 22.0° / 46.0°  
 Efficiency 82 %  
 Peak intensity 4 cd/lm  
 LEDs/each optic 1  
 Light colour White  
 Required components:  
 F15254\_HEKLA-SOCKET-B

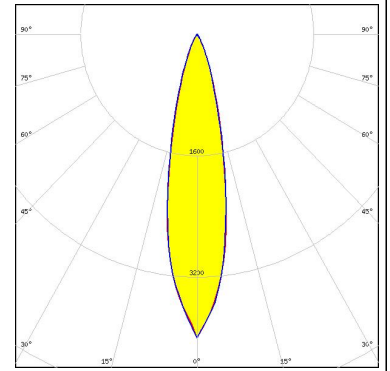

#### LUMILEDS

LED LUXEON CX Plus CoB M02 / M03 (Gen2)  
 Ordering code CP18723\_YASMEEN-50-S-C2  
 FWHM / FWTM 20.0° / 37.0°  
 Efficiency 87 %  
 Peak intensity 6.1 cd/lm  
 LEDs/each optic 1  
 Light colour White  
 Required components:  
 F15256\_HEKLA-SOCKET-D

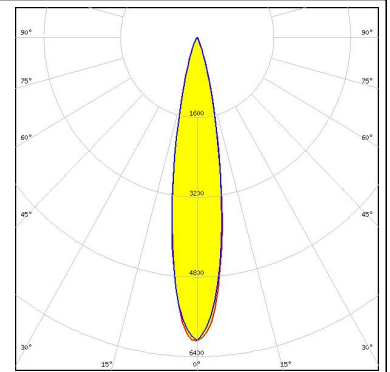

#### LUMILEDS

LED LUXEON CX Plus CoB S01 (Gen2)  
 Ordering code CP18723\_YASMEEN-50-S-C2  
 FWHM / FWTM 14.0° / 28.0°  
 Efficiency 89 %  
 Peak intensity 10.3 cd/lm  
 LEDs/each optic 1  
 Light colour White  
 Required components:  
 F15956\_HEKLA-SOCKET-J

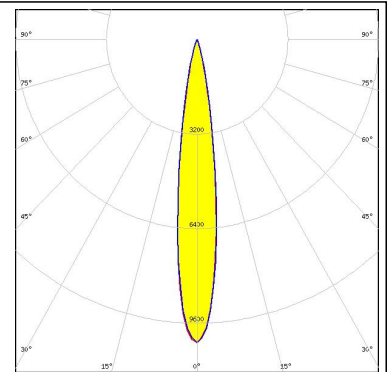

### OPTICAL RESULTS (SIMULATED):



**LED** CHM-9 XH (19x19)  
**Ordering code** CP18723\_YASMEEN-50-S-C2  
**FWHM / FWTM** 18.0° / 36.0°  
**Efficiency** 88 %  
**Peak intensity** 6.8 cd/lm  
**LEDs/each optic** 1  
**Light colour** White  
**Required components:**  
 F15859\_HEKLA-SOCKET-I

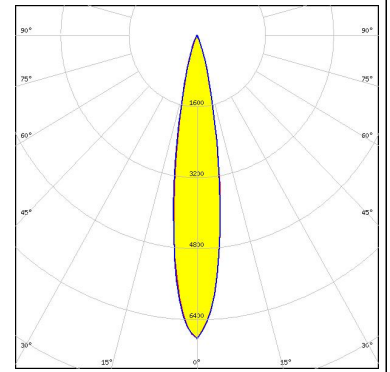

**LED** CTM-6 (Tunable White) Gen2  
**Ordering code** CP18723\_YASMEEN-50-S-C2  
**FWHM / FWTM** 16.0° / 32.0°  
**Efficiency** 89 %  
**Peak intensity** 8.5 cd/lm  
**LEDs/each optic** 1  
**Light colour** Tunable White  
**Required components:**  
 C16142\_HEKLA-SOCKET-K  
 Bender Wirth: 495 Typ L8

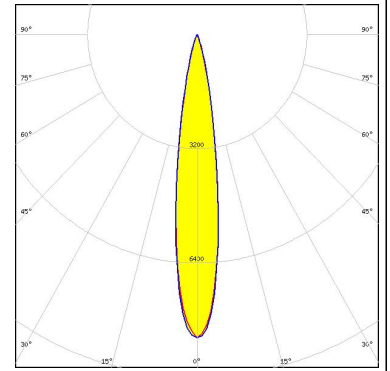

**LED** CTM-9 (Tunable White) Gen2  
**Ordering code** CP18723\_YASMEEN-50-S-C2  
**FWHM / FWTM** 18.0° / 37.0°  
**Efficiency** 86 %  
**Peak intensity** 6.3 cd/lm  
**LEDs/each optic** 1  
**Light colour** Tunable White  
**Required components:**  
 C16142\_HEKLA-SOCKET-K  
 Bender Wirth: 495 Typ L8

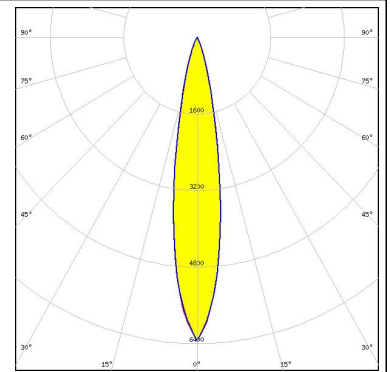

**LED** CxM-6 (13.5x13.5)  
**Ordering code** CP18730\_YASMEEN-50-S-B2  
**FWHM / FWTM** 14.0° / 28.0°  
**Efficiency** 89 %  
**Peak intensity** 10.2 cd/lm  
**LEDs/each optic** 1  
**Light colour** White  
**Required components:**  
 BJB: 47.360.1020

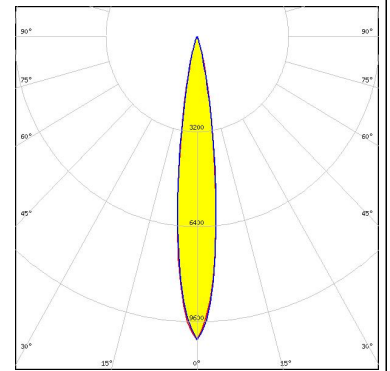

### OPTICAL RESULTS (SIMULATED):

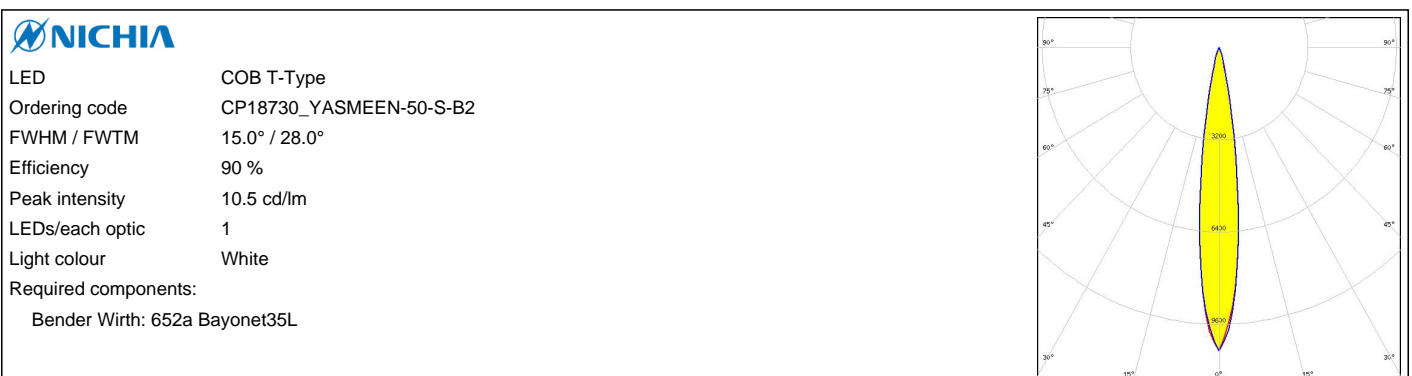
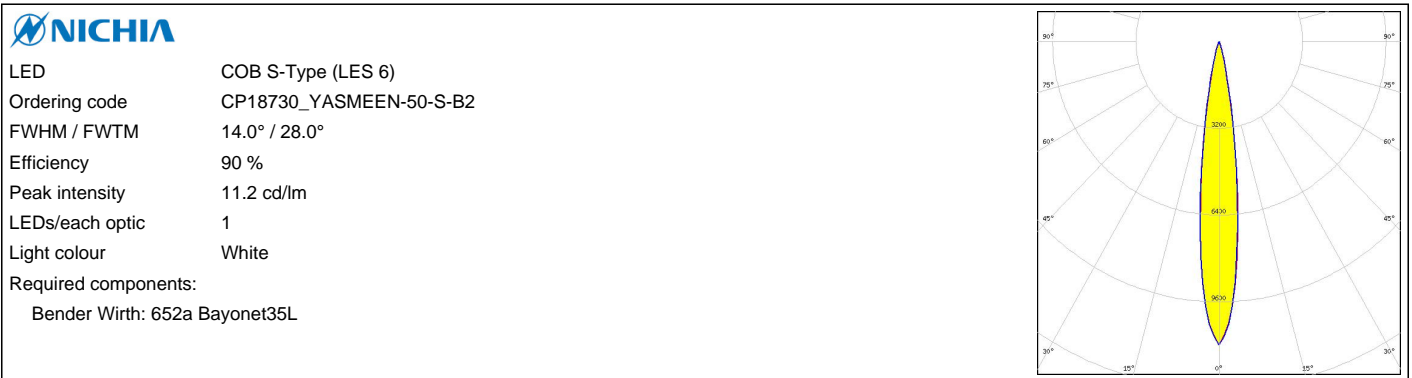
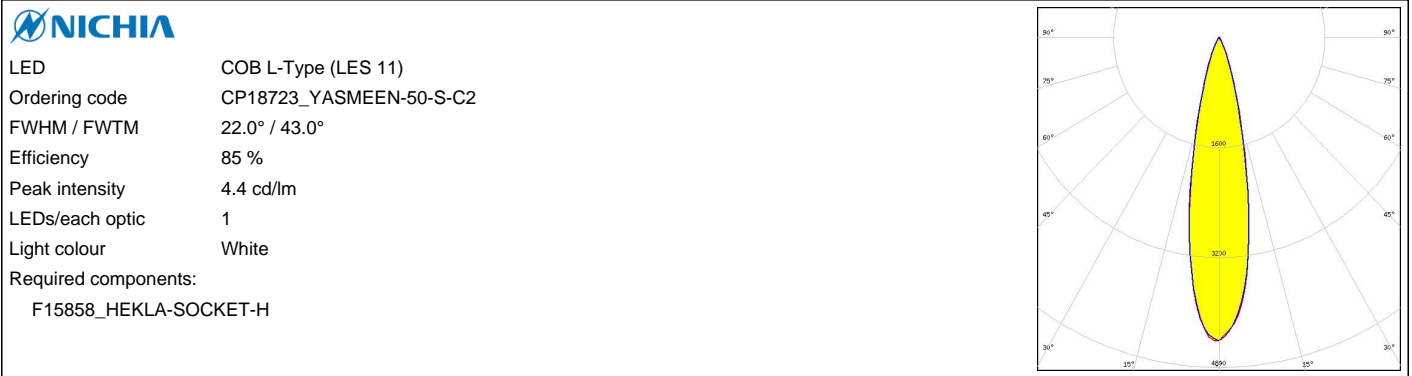

### OPTICAL RESULTS (SIMULATED):



**LED** NJCWL024Z-V1MT: COB L-Type Tunable White  
**Ordering code** CP18723\_YASMEEN-50-S-C2  
**FWHM / FWTM** 16.0° / 32.0°  
**Efficiency** 88 %  
**Peak intensity** 8.6 cd/lm  
**LEDs/each optic** 1  
**Light colour** Tunable White  
**Required components:**  
 C16142\_HEKLA-SOCKET-K  
 Bender Wirth: 497 Typ L8 HV

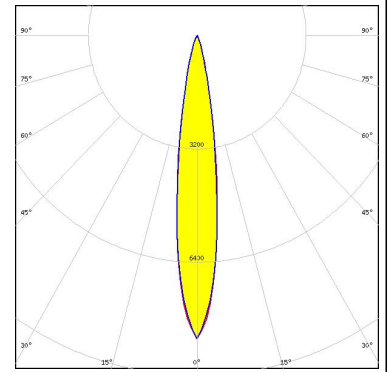

**LED** NJNWS012Z-V1MT: COB S-Type Tunable White  
**Ordering code** CP18723\_YASMEEN-50-S-C2  
**FWHM / FWTM** 14.0° / 28.0°  
**Efficiency** 89 %  
**Peak intensity** 11.2 cd/lm  
**LEDs/each optic** 1  
**Light colour** Tunable White  
**Required components:**  
 C16142\_HEKLA-SOCKET-K  
 Bender Wirth: 495 Typ L8 HV

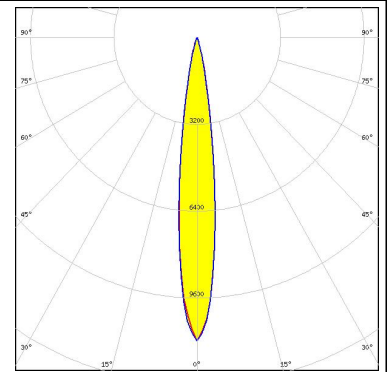

**LED** NVCWJ024Z-V1MT: COB J-Type Tunable White  
**Ordering code** CP18723\_YASMEEN-50-S-C2  
**FWHM / FWTM** 20.0° / 42.0°  
**Efficiency** 83 %  
**Peak intensity** 4.9 cd/lm  
**LEDs/each optic** 1  
**Light colour** Tunable White  
**Required components:**  
 C16142\_HEKLA-SOCKET-K  
 Bender Wirth: 498 Typ L8 HV

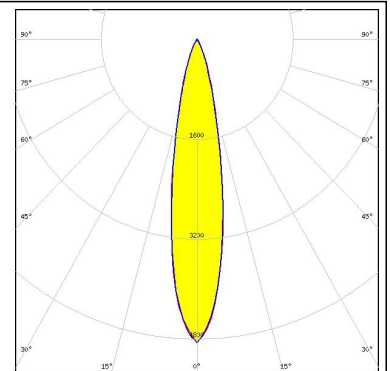

**LED** LC010C G2  
**Ordering code** CP18730\_YASMEEN-50-S-B2  
**FWHM / FWTM** 14.0° / 28.0°  
**Efficiency** 90 %  
**Peak intensity** 10.4 cd/lm  
**LEDs/each optic** 1  
**Light colour** White  
**Required components:**  
 BJB: 47.360.1020

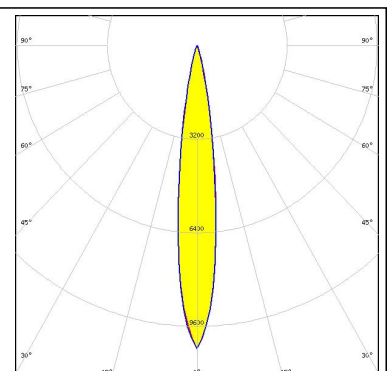

### OPTICAL RESULTS (SIMULATED):

#### SAMSUNG

LED LC010T (Tunable White)  
 Ordering code CP18723\_YASMEEN-50-S-C2  
 FWHM / FWTM 17.0° / 34.0°  
 Efficiency 87 %  
 Peak intensity 7.4 cd/lm  
 LEDs/each optic 1  
 Light colour Tunable White  
 Required components:  
 C16142\_HEKLA-SOCKET-K  
 Bender Wirth: 501 Typ L8

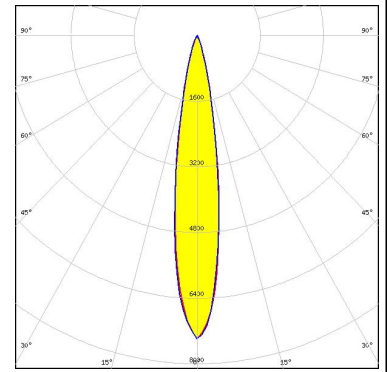

#### SAMSUNG

LED LC016D / LC019D / LC026D / LC033D  
 Ordering code CP18730\_YASMEEN-50-S-B2  
 FWHM / FWTM 28.0° / 54.0°  
 Efficiency 74 %  
 Peak intensity 2.5 cd/lm  
 LEDs/each optic 1  
 Light colour White  
 Required components:  
 BJB: 47.360.1010

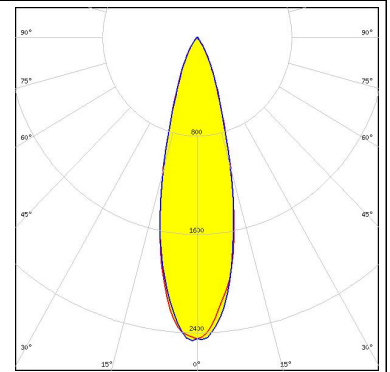

#### SAMSUNG

LED LC020C G2  
 Ordering code CP18730\_YASMEEN-50-S-B2  
 FWHM / FWTM 18.0° / 36.0°  
 Efficiency 86 %  
 Peak intensity 6.7 cd/lm  
 LEDs/each optic 1  
 Light colour White  
 Required components:  
 BJB: 47.360.1010

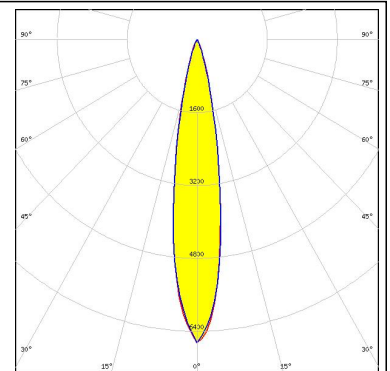

#### SAMSUNG

LED LC030C/040C G2  
 Ordering code CP18730\_YASMEEN-50-S-B2  
 FWHM / FWTM 23.0° / 45.0°  
 Efficiency 82 %  
 Peak intensity 4.1 cd/lm  
 LEDs/each optic 1  
 Light colour White  
 Required components:  
 BJB: 47.360.1010

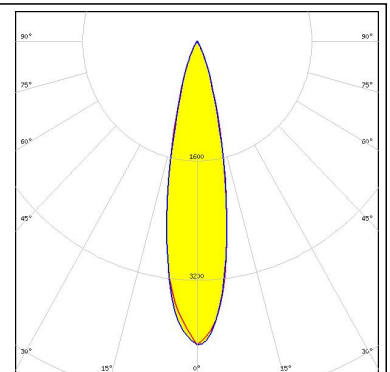

### OPTICAL RESULTS (SIMULATED):

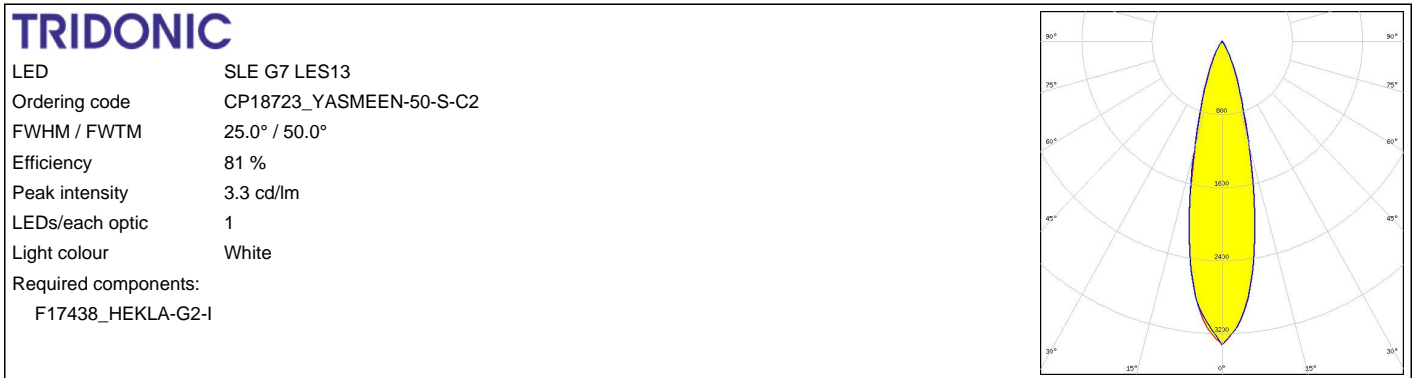

### GENERAL INFORMATION:

NOTE: The typical beam angle will be changed by different color, chip size and chip position tolerance. The typical total beam angle is the full angle measured where the luminous intensity is half of the peak value.

Due to use of high power COB's with this product, special attention to proper thermal design is highly recommended. LEDiL has no liability for direct, indirect or consecutive damages arising from the LEDiL products being used outside of the recommended temperature range.

### MATERIALS:

As part of our continuous research and improvement processes, and to ensure the best possible quality and availability of our products, LEDiL reserves the right to change material grades without notice.

### PRODUCT DATA USER AGREEMENT AND DISCLAIMER:

The measured data in the provided downloadable LEDiL Product Datasheets and Mechanical 2D-Drawings is rounded and provided as reference for planning. LEDiL Oy's optical specifications have been verified by conducting performance testing of the products in accordance with the company's quality system. The reported data are averaged results of multiple measurements with typical variation. LEDiL Oy reserves the right to without prior notification make changes and improvements to its products.

LEDiL Oy assumes neither warranty, nor guarantee nor any other liability of any kind for the contents and correctness of the provided data. The provided data has been generated with highest diligence but the provided data may in reality not represent the complete possible variation range of all intrinsic parameters. Therefore, in certain cases a deviation from the provided data could occur.

LEDiL Oy reserves the right to undertake technical changes of its products without further notification which could lead to changes in the provided data. LEDiL Oy assumes no liability of any kind for the possible deviation from any provided data or any other damage resulting from the usage of the provided data.

The user agrees to this disclaimer and user agreement with the download or usage of the provided files.

#### LEDiL Oy

Joensuunkatu 13  
FI-24240 SALO  
Finland

#### LEDiL Inc.

228 West Page Street  
Suite D  
Sycamore IL 60178  
USA

#### Ledil Optics Technology (Shenzhen) Co., Ltd.

# 405 , Block B  
Casic Motor Building  
Shenzhen 518057  
P.R.CHINA

#### Local sales and technical support

[www.ledil.com/  
where\\_to\\_buy](http://www.ledil.com/where_to_buy)

#### Shipping locations

Salo, Finland  
Hong Kong, China

#### Distribution Partners

[www.ledil.com/  
where\\_to\\_buy](http://www.ledil.com/where_to_buy)