

## YASMEEN-50-M

~26° medium beam

### SPECIFICATION:

Dimensions	Ø 49.9 mm
Height	27.6 mm
Fastening	socket
ROHS compliant	yes ⓘ

### MATERIALS:

Component	Type	Material	Colour	Finish
YASMEEN-50-M	Single lens	PMMA	clear	
YASMEEN-50-HLD2-C	Holder C	PC	black	
YASMEEN-50-HLD2-B	Holder B	PC	black	
YASMEEN-50-HLD2-C-WHT	Holder C	PC	white	
YASMEEN-50-HLD2-B-WHT	Holder B	PC	white	



### ORDERING INFORMATION:

Component	Qty in box	MOQ	MPQ	Box weight (kg)
C17235_YASMEEN-50-M	252	112	28	7.8
<b>Assembly</b>				
CP18745_YASMEEN-50-M-B2-WHT	252	112	28	9.3
CP18738_YASMEEN-50-M-C2-WHT	252	112	28	9.1
CP18731_YASMEEN-50-M-B2	252	112	28	9.3
CP18724_YASMEEN-50-M-C2	252	112	28	9.0

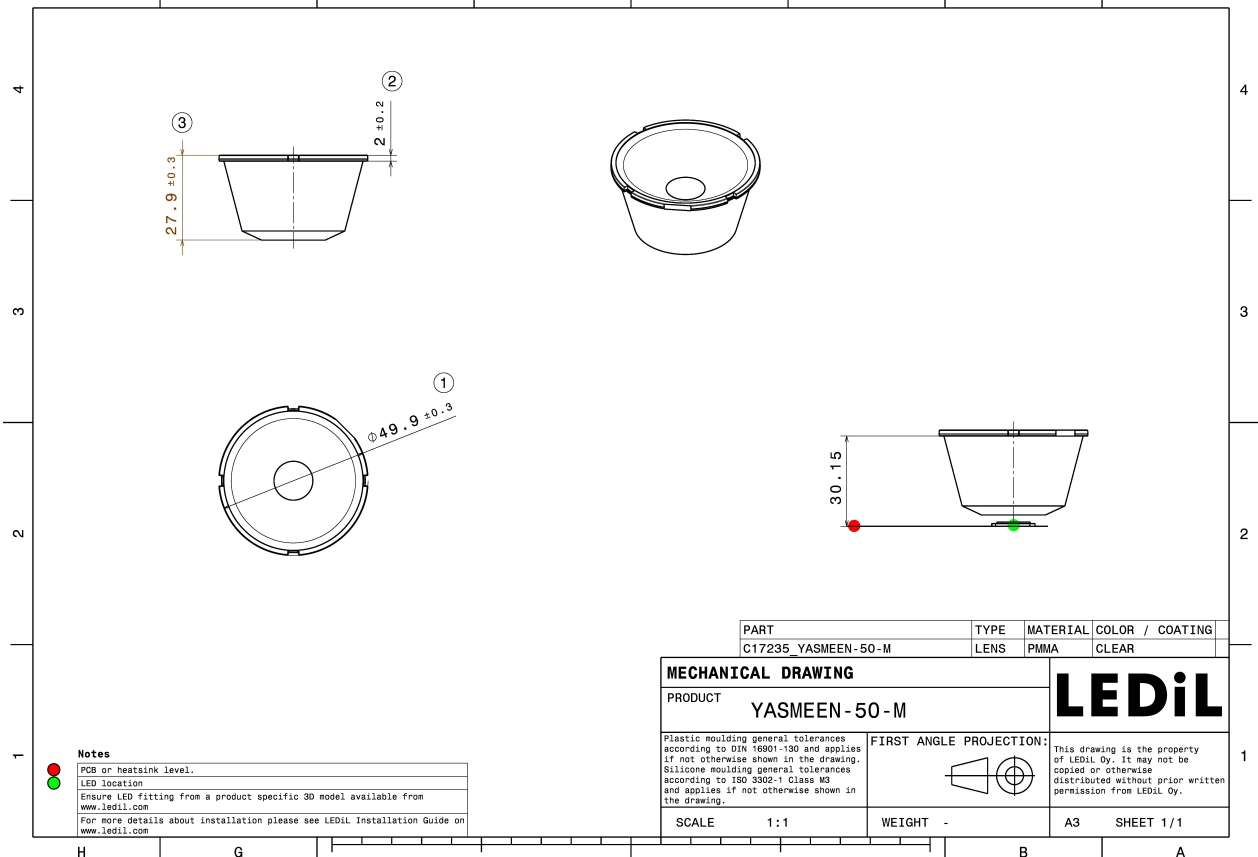
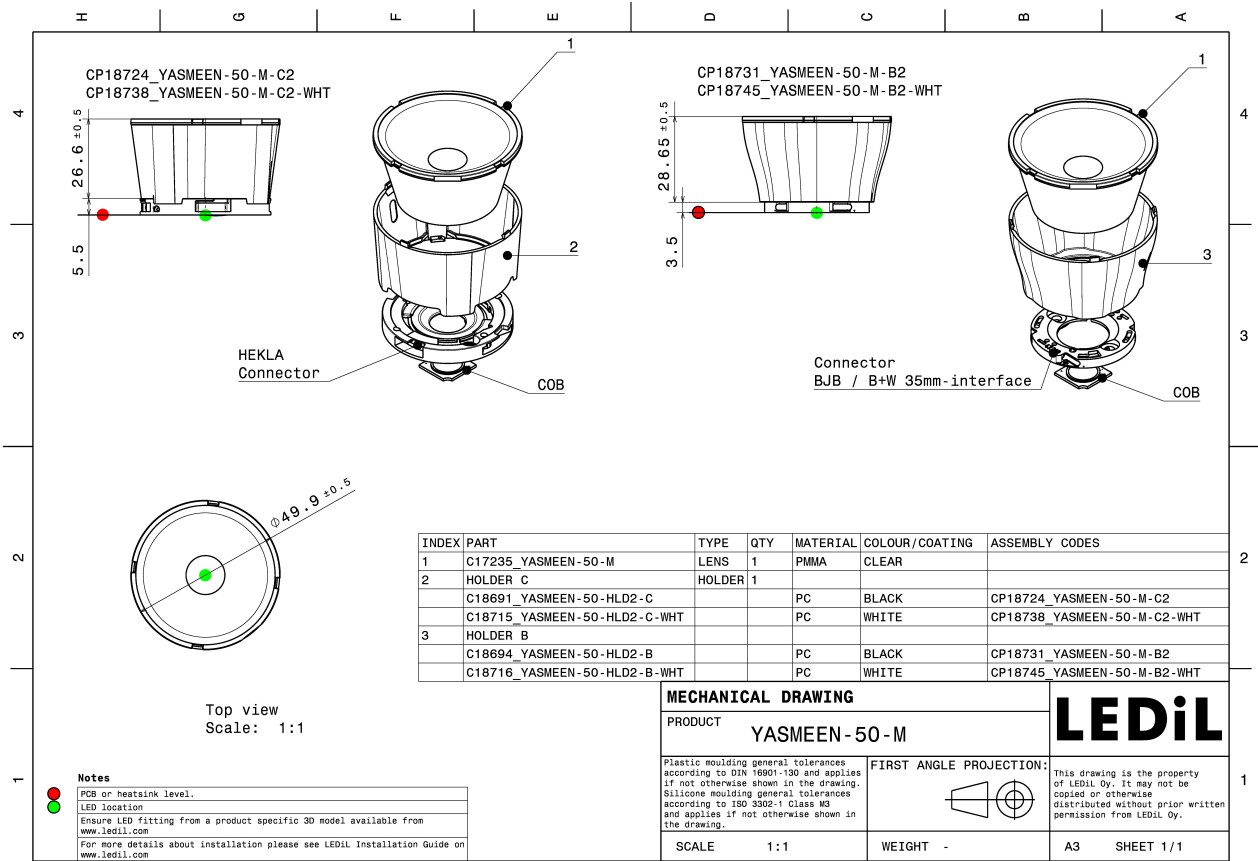

See also our general installation guide: [www.ledil.com/installation\\_guide](http://www.ledil.com/installation_guide)

### OPTICAL RESULTS (MEASURED):

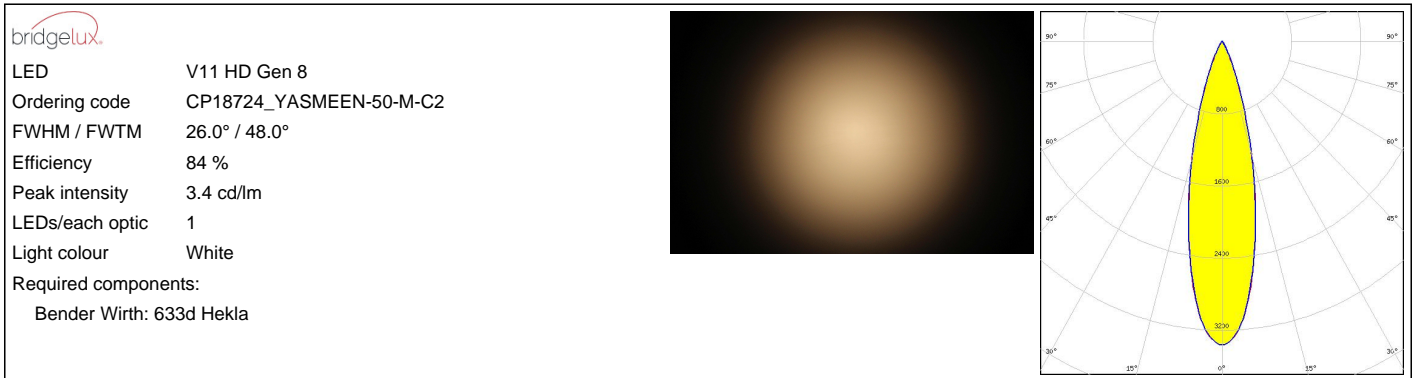
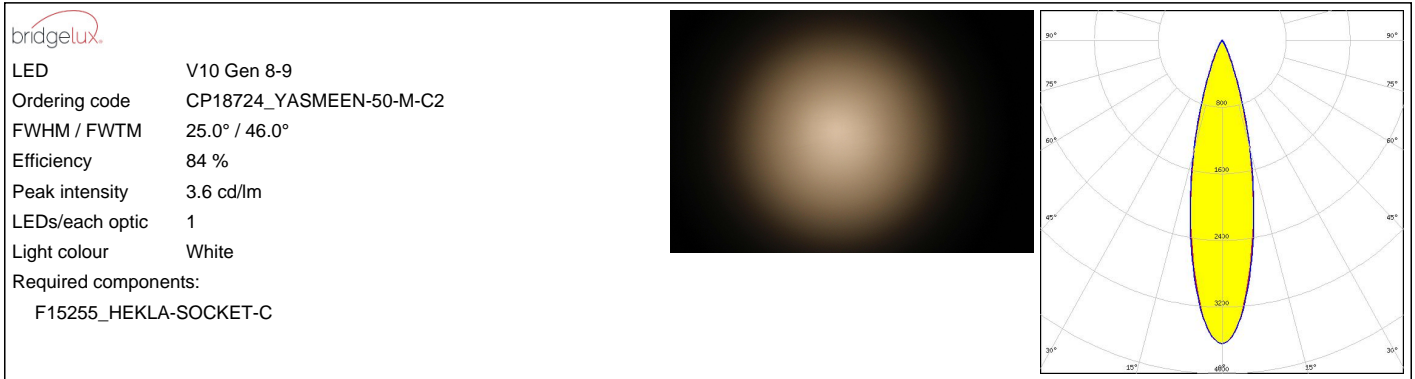

### OPTICAL RESULTS (MEASURED):

			
LED	V4 HD Gen 7		
Ordering code	CP18738_YASMEEN-50-M-C2-WHT		
FWHM / FWTM	25.0° / 42.0°		
Efficiency	92 %		
Peak intensity	4 cd/lm		
LEDs/each optic	1		
Light colour	White		
Required components:			
F15253_HEKLA-SOCKET-A			

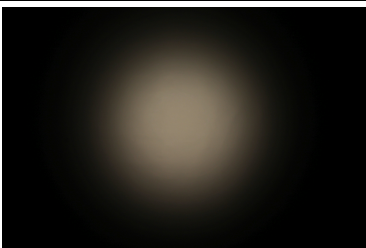
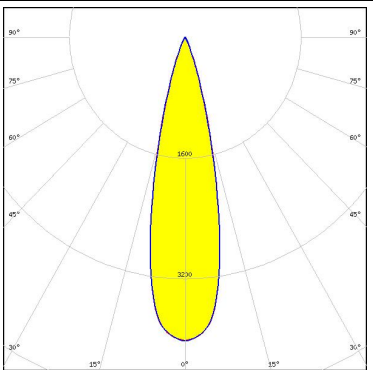
			
LED	V4 HD Gen 7		
Ordering code	CP18724_YASMEEN-50-M-C2		
FWHM / FWTM	25.0° / 42.0°		
Efficiency	85 %		
Peak intensity	4 cd/lm		
LEDs/each optic	1		
Light colour	White		
Required components:			
F15253_HEKLA-SOCKET-A			

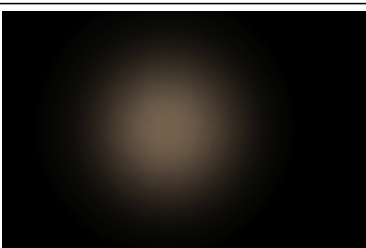
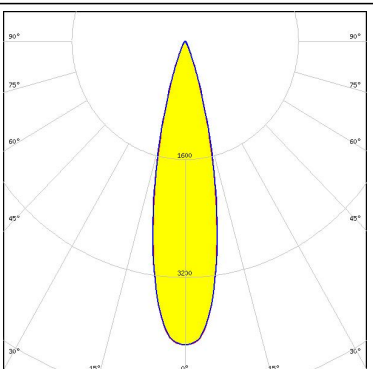
			
LED	V6 HD Gen 7		
Ordering code	CP18738_YASMEEN-50-M-C2-WHT		
FWHM / FWTM	24.0° / 42.0°		
Efficiency	92 %		
Peak intensity	4.1 cd/lm		
LEDs/each optic	1		
Light colour	White		
Required components:			
F15255_HEKLA-SOCKET-C			

			
LED	V6 HD Gen 7		
Ordering code	CP18724_YASMEEN-50-M-C2		
FWHM / FWTM	24.0° / 43.0°		
Efficiency	85 %		
Peak intensity	4.1 cd/lm		
LEDs/each optic	1		
Light colour	White		
Required components:			
F15255_HEKLA-SOCKET-C			

### OPTICAL RESULTS (MEASURED):

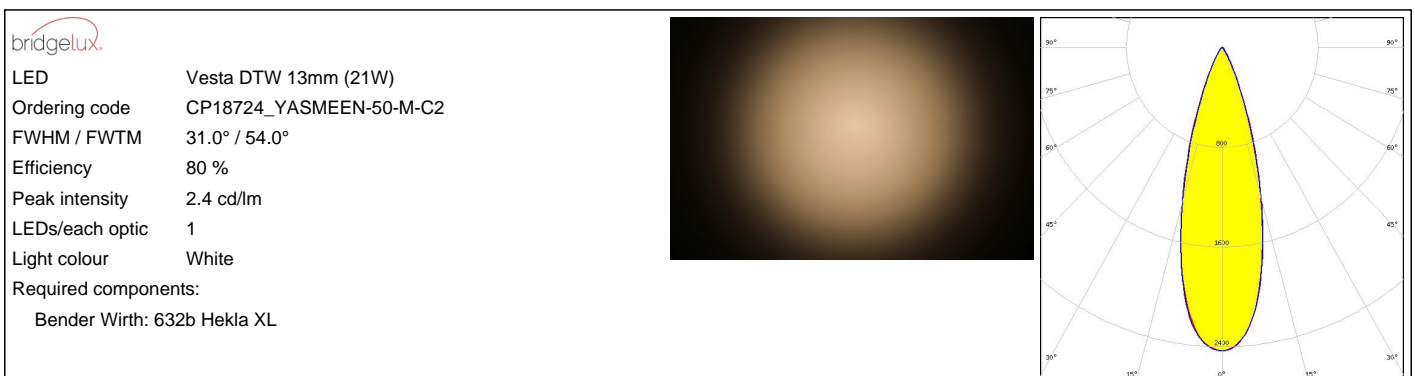
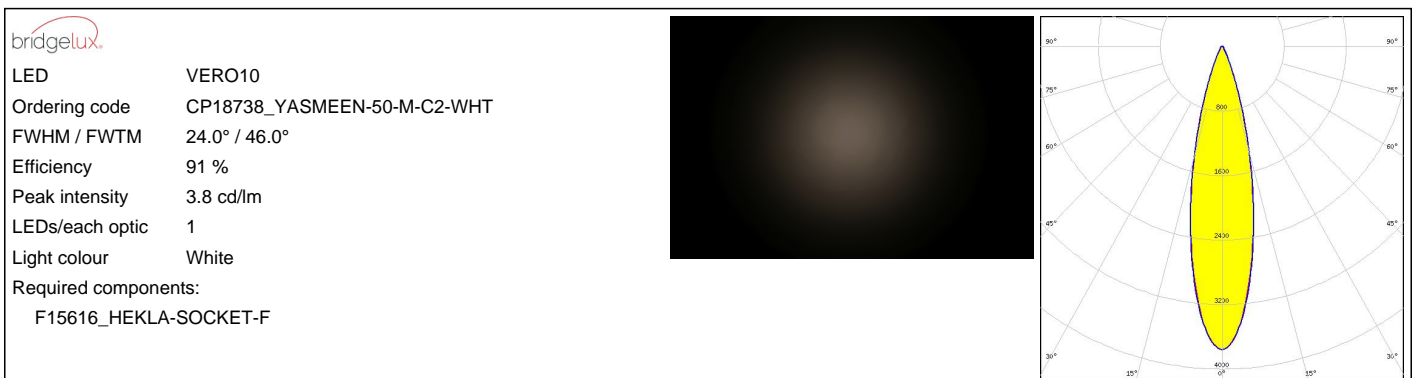

### OPTICAL RESULTS (MEASURED):

bridgelux

LED Vesta DTW 15mm (33W)  
 Ordering code CP18724\_YASMEEN-50-M-C2  
 FWHM / FWTM 33.0° / 57.0°  
 Efficiency 79 %  
 Peak intensity 2.2 cd/lm  
 LEDs/each optic 1  
 Light colour White  
 Required components:  
 Bender Wirth: 632b Hekla XL

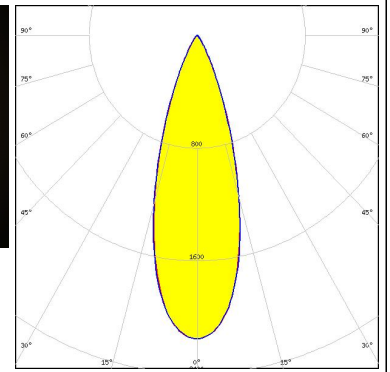
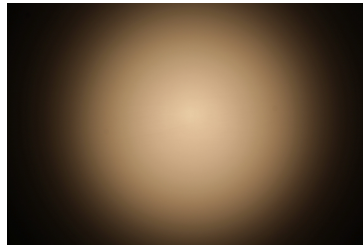

bridgelux

LED Vesta DTW 15mm (33W)  
 Ordering code CP18738\_YASMEEN-50-M-C2-WHT  
 FWHM / FWTM 33.0° / 59.0°  
 Efficiency 89 %  
 Peak intensity 2.1 cd/lm  
 LEDs/each optic 1  
 Light colour White  
 Required components:  
 Bender Wirth: 632b Hekla XL

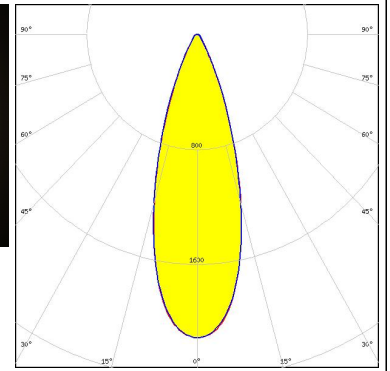

bridgelux

LED Vesta DTW 9mm (4W/6W/12W)  
 Ordering code CP18724\_YASMEEN-50-M-C2  
 FWHM / FWTM 23.0° / 45.0°  
 Efficiency 84 %  
 Peak intensity 4 cd/lm  
 LEDs/each optic 1  
 Light colour White  
 Required components:  
 Bender Wirth: 652b Hekla

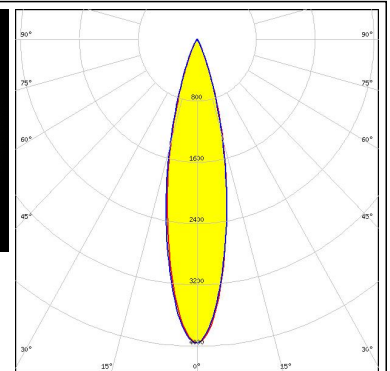
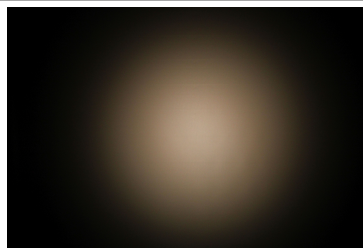

### CITIZEN

LED CLL02x/CLU02x (LES10)  
 Ordering code CP18738\_YASMEEN-50-M-C2-WHT  
 FWHM / FWTM 25.0° / 46.0°  
 Efficiency 91 %  
 Peak intensity 3.7 cd/lm  
 LEDs/each optic 1  
 Light colour White  
 Required components:  
 F17435\_HEKLA-G2-C

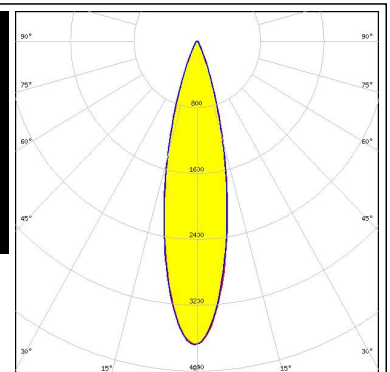
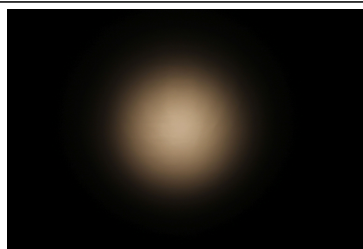

### OPTICAL RESULTS (MEASURED):

#### CITIZEN

LED CLL02x/CLU02x (LES10)  
Ordering code CP18724\_YASMEEN-50-M-C2  
FWHM / FWTM 24.0° / 46.0°  
Efficiency 84 %  
Peak intensity 3.7 cd/lm  
LEDs/each optic 1  
Light colour White  
Required components:  
F17435\_HEKLA-G2-C

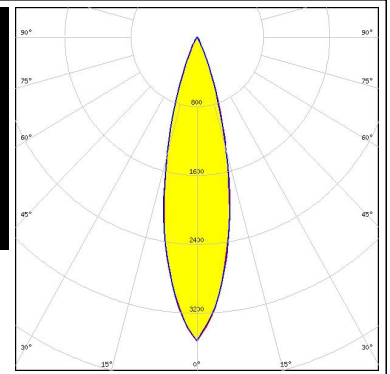
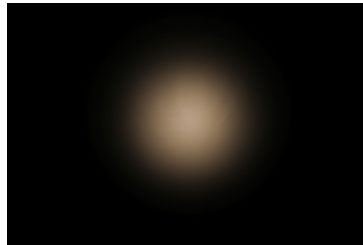

#### CITIZEN

LED CLU700/701/702/703  
Ordering code CP18724\_YASMEEN-50-M-C2  
FWHM / FWTM 24.0° / 43.0°  
Efficiency 85 %  
Peak intensity 4 cd/lm  
LEDs/each optic 1  
Light colour White  
Required components:  
F17435\_HEKLA-G2-C

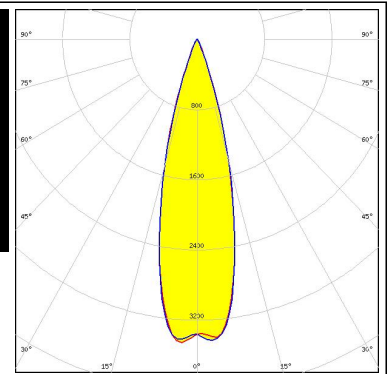
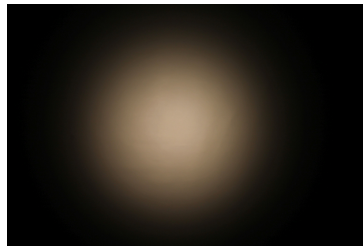

#### CITIZEN

LED CLU700/701/702/703  
Ordering code CP18738\_YASMEEN-50-M-C2-WHT  
FWHM / FWTM 24.0° / 42.0°  
Efficiency 92 %  
Peak intensity 4.1 cd/lm  
LEDs/each optic 1  
Light colour White  
Required components:  
F17435\_HEKLA-G2-C

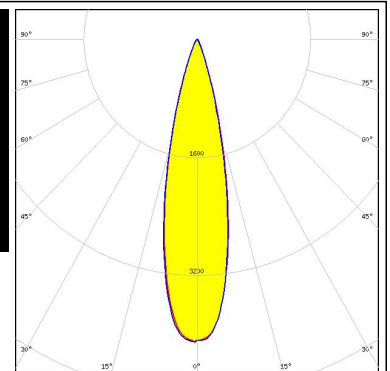
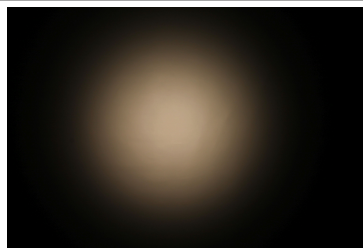

#### CITIZEN

LED CLU7A2/7A3  
Ordering code CP18724\_YASMEEN-50-M-C2  
FWHM / FWTM 25.0° / 42.0°  
Efficiency 85 %  
Peak intensity 4 cd/lm  
LEDs/each optic 1  
Light colour White  
Required components:  
F17435\_HEKLA-G2-C

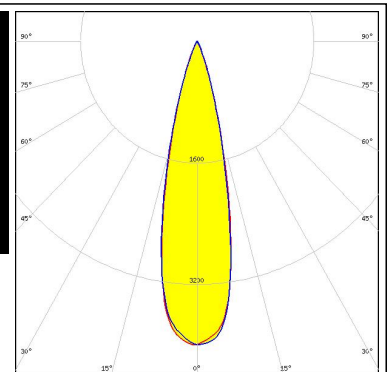



### OPTICAL RESULTS (MEASURED):

#### CITIZEN

LED CLU7A2/7A3  
 Ordering code CP18738\_YASMEEN-50-M-C2-WHT  
 FWHM / FWTM 25.0° / 41.5°  
 Efficiency 92 %  
 Peak intensity 4 cd/lm  
 LEDs/each optic 1  
 Light colour White  
 Required components:  
 F17435\_HEKLA-G2-C

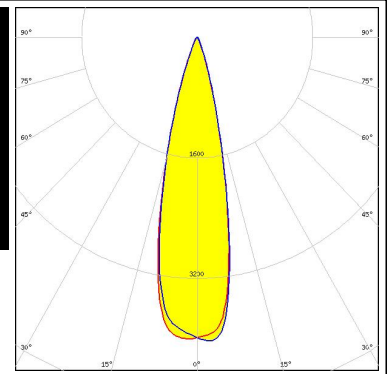

#### CITIZEN

LED CLU7B2  
 Ordering code CP18724\_YASMEEN-50-M-C2  
 FWHM / FWTM 25.0° / 42.0°  
 Efficiency 85 %  
 Peak intensity 3.8 cd/lm  
 LEDs/each optic 1  
 Light colour White  
 Required components:  
 F17435\_HEKLA-G2-C

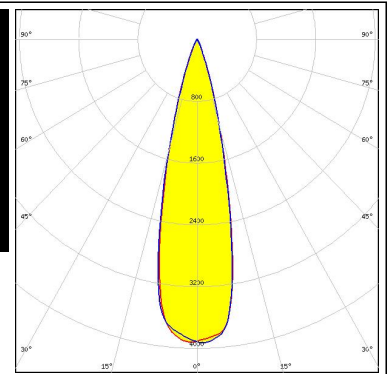
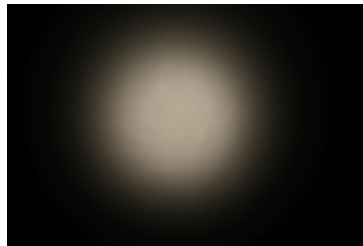

#### CITIZEN

LED CLU7B2  
 Ordering code CP18738\_YASMEEN-50-M-C2-WHT  
 FWHM / FWTM 26.0° / 42.0°  
 Efficiency 92 %  
 Peak intensity 3.8 cd/lm  
 LEDs/each optic 1  
 Light colour White  
 Required components:  
 F17435\_HEKLA-G2-C

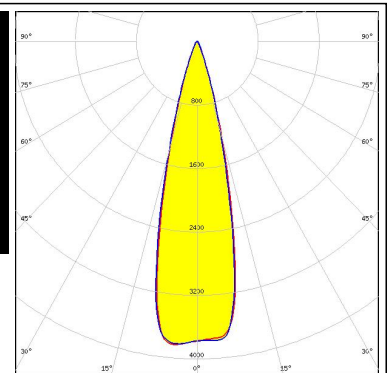

#### CREE LEDS

LED CMA1516  
 Ordering code CP18724\_YASMEEN-50-M-C2  
 FWHM / FWTM 24.0° / 45.0°  
 Efficiency 84 %  
 Peak intensity 3.9 cd/lm  
 LEDs/each optic 1  
 Light colour White  
 Required components:  
 F17436\_HEKLA-G2-D

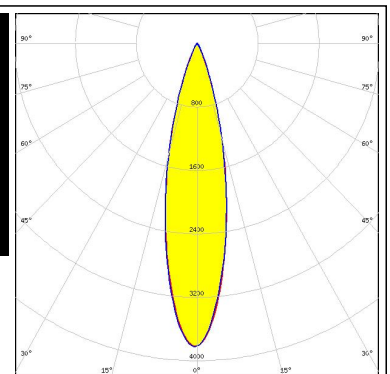
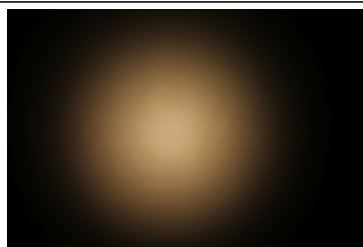

### OPTICAL RESULTS (MEASURED):



**LED** CMA1516  
**Ordering code** CP18738\_YASMEEN-50-M-C2-WHT  
**FWHM / FWTM** 24.0° / 45.0°  
**Efficiency** 91 %  
**Peak intensity** 3.9 cd/lm  
**LEDs/each optic** 1  
**Light colour** White  
**Required components:**  
 F17436\_HEKLA-G2-D

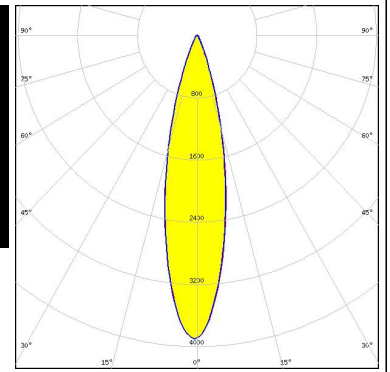

**LED** CMT14xx  
**Ordering code** CP18724\_YASMEEN-50-M-C2  
**FWHM / FWTM** 24.0° / 46.0°  
**Efficiency** 84 %  
**Peak intensity** 3.7 cd/lm  
**LEDs/each optic** 1  
**Light colour** White  
**Required components:**  
 F17435\_HEKLA-G2-C

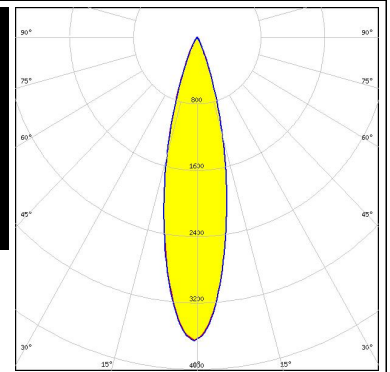
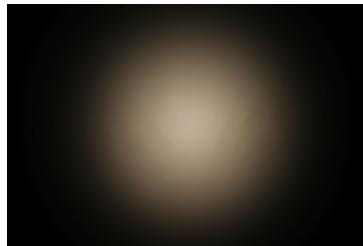

**LED** CMT14xx  
**Ordering code** CP18738\_YASMEEN-50-M-C2-WHT  
**FWHM / FWTM** 24.0° / 46.0°  
**Efficiency** 91 %  
**Peak intensity** 3.7 cd/lm  
**LEDs/each optic** 1  
**Light colour** White  
**Required components:**  
 F17435\_HEKLA-G2-C

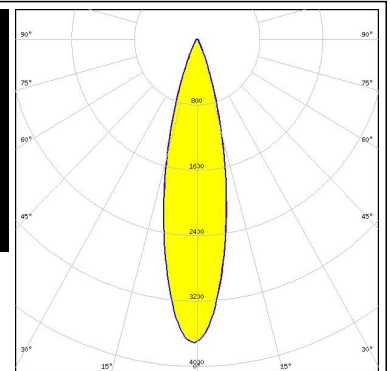
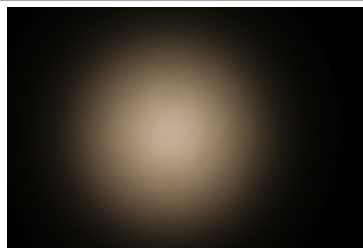

**LED** CMU10xx  
**Ordering code** CP18724\_YASMEEN-50-M-C2  
**FWHM / FWTM** 25.0° / 47.0°  
**Efficiency** 83 %  
**Peak intensity** 3.5 cd/lm  
**LEDs/each optic** 1  
**Light colour** White  
**Required components:**  
 F17435\_HEKLA-G2-C

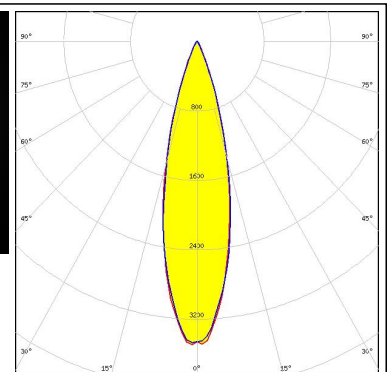
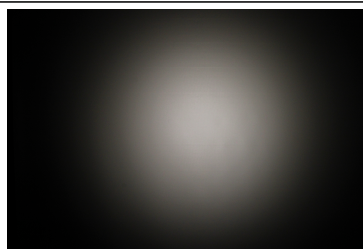

### OPTICAL RESULTS (MEASURED):



**LED** CXA/B 13xx  
**Ordering code** CP18738\_YASMEEN-50-M-C2-WHT  
**FWHM / FWTM** 25.0° / 43.0°  
**Efficiency** 93 %  
**Peak intensity** 4 cd/lm  
**LEDs/each optic** 1  
**Light colour** White  
**Required components:**  
 F17439\_HEKLA-G2-J

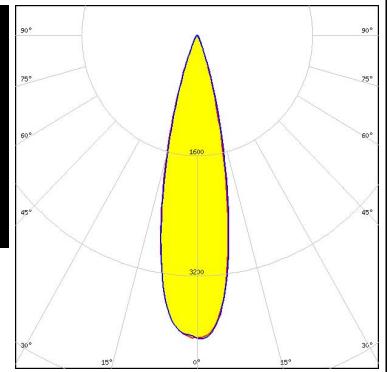
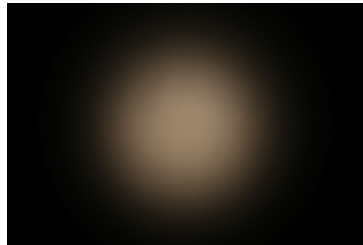

**LED** CXA/B 13xx  
**Ordering code** CP18724\_YASMEEN-50-M-C2  
**FWHM / FWTM** 25.0° / 43.0°  
**Efficiency** 86 %  
**Peak intensity** 4 cd/lm  
**LEDs/each optic** 1  
**Light colour** White  
**Required components:**  
 F17439\_HEKLA-G2-J

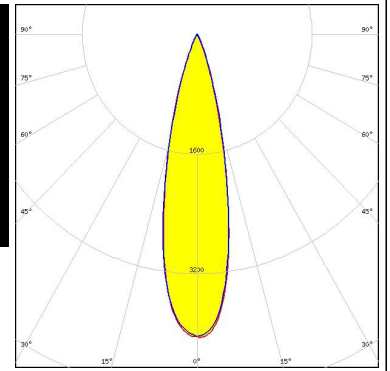

**LED** CXA/B 15xx  
**Ordering code** CP18724\_YASMEEN-50-M-C2  
**FWHM / FWTM** 24.0° / 45.0°  
**Efficiency** 84 %  
**Peak intensity** 3.9 cd/lm  
**LEDs/each optic** 1  
**Light colour** White  
**Required components:**  
 F17436\_HEKLA-G2-D

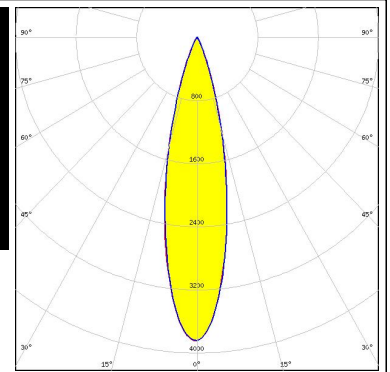
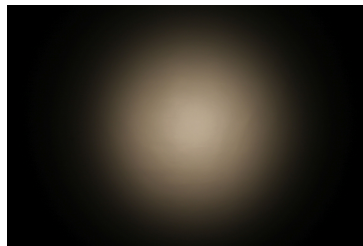

**LED** CXA/B 15xx  
**Ordering code** CP18738\_YASMEEN-50-M-C2-WHT  
**FWHM / FWTM** 24.0° / 45.0°  
**Efficiency** 92 %  
**Peak intensity** 3.9 cd/lm  
**LEDs/each optic** 1  
**Light colour** White  
**Required components:**  
 F17436\_HEKLA-G2-D

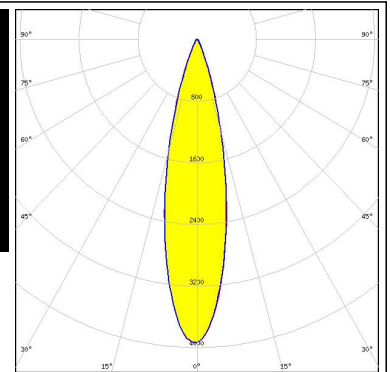
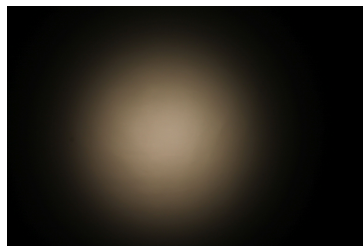

### OPTICAL RESULTS (MEASURED):



### OPTICAL RESULTS (MEASURED):

#### LUMILEDS

LED LUXEON CoB 1204HD  
 Ordering code CP18738\_YASMEEN-50-M-C2-WHT  
 FWHM / FWTM 23.0° / 45.0°  
 Efficiency 91 %  
 Peak intensity 4 cd/lm  
 LEDs/each optic 1  
 Light colour White  
 Required components:  
 F17437\_HEKLA-G2-H

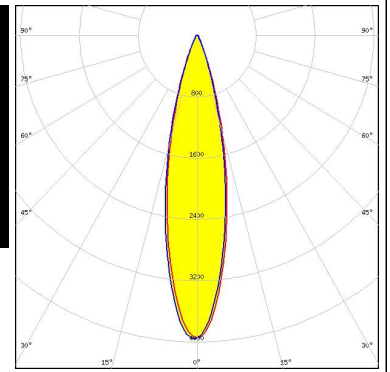
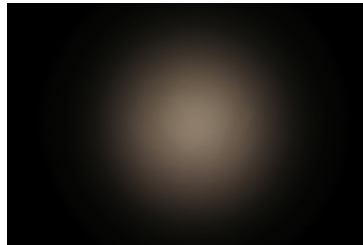

#### LUMILEDS

LED LUXEON CoB M02/M03  
 Ordering code CP18738\_YASMEEN-50-M-C2-WHT  
 FWHM / FWTM 24.0° / 45.0°  
 Efficiency 92 %  
 Peak intensity 3.9 cd/lm  
 LEDs/each optic 1  
 Light colour White  
 Required components:  
 F17436\_HEKLA-G2-D

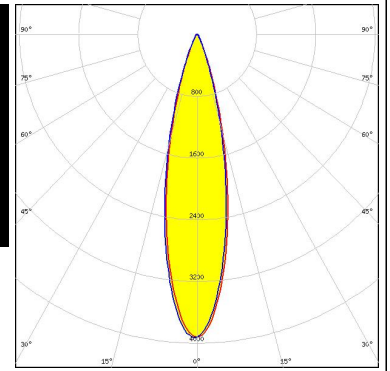

#### LUMILEDS

LED LUXEON CoB M02/M03  
 Ordering code CP18724\_YASMEEN-50-M-C2  
 FWHM / FWTM 24.0° / 45.0°  
 Efficiency 84 %  
 Peak intensity 3.9 cd/lm  
 LEDs/each optic 1  
 Light colour White  
 Required components:  
 F17436\_HEKLA-G2-D

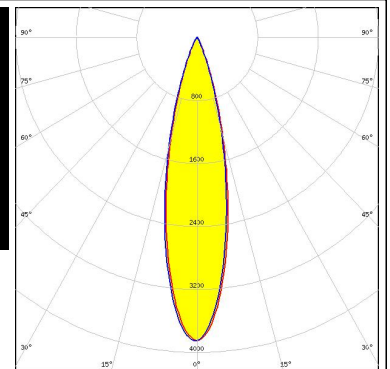
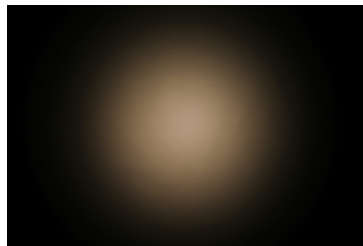

#### LUMILEDS

LED LUXEON CoB S01  
 Ordering code CP18724\_YASMEEN-50-M-C2  
 FWHM / FWTM 24.0° / 42.0°  
 Efficiency 85 %  
 Peak intensity 4.1 cd/lm  
 LEDs/each optic 1  
 Light colour White  
 Required components:  
 F17439\_HEKLA-G2-J

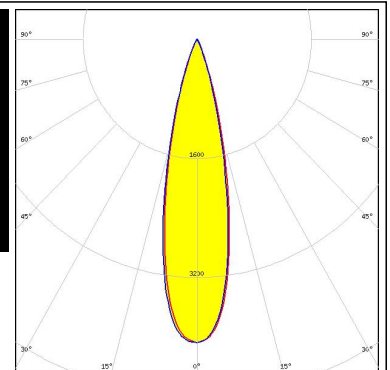
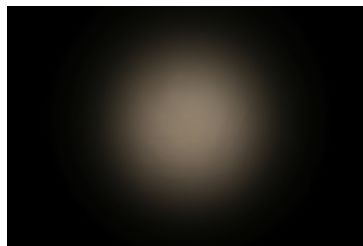

### OPTICAL RESULTS (MEASURED):



LED LUXEON CoB S01  
Ordering code CP18738\_YASMEEN-50-M-C2-WHT  
FWHM / FWTM 24.0° / 42.0°  
Efficiency 92 %  
Peak intensity 4.1 cd/lm  
LEDs/each optic 1  
Light colour White  
Required components:  
F17439\_HEKLA-G2-J

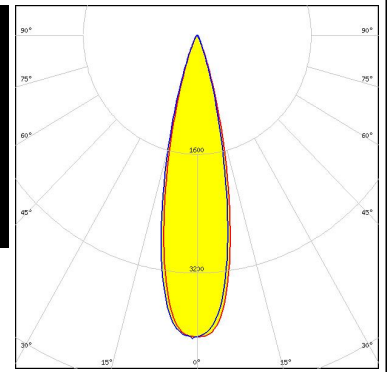

LED CTM-14 (Tunable White) Gen2  
Ordering code CP18724\_YASMEEN-50-M-C2  
FWHM / FWTM 29.0° / 53.0°  
Efficiency 77 %  
Peak intensity 2.5 cd/lm  
LEDs/each optic 1  
Light colour Tunable White  
Required components:  
C16142\_HEKLA-SOCKET-K  
Bender Wirth: 442 Typ L8

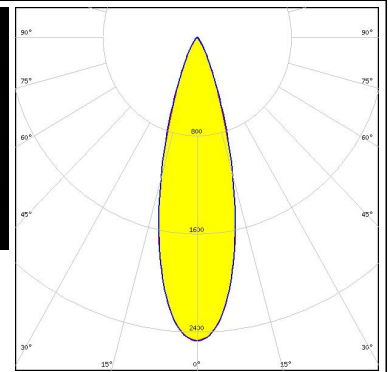
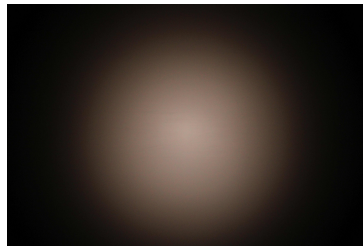

LED CXM-3  
Ordering code CP18724\_YASMEEN-50-M-C2  
FWHM / FWTM 25.0° / 42.0°  
Efficiency 85 %  
Peak intensity 4 cd/lm  
LEDs/each optic 1  
Light colour White  
Required components:  
F17435\_HEKLA-G2-C

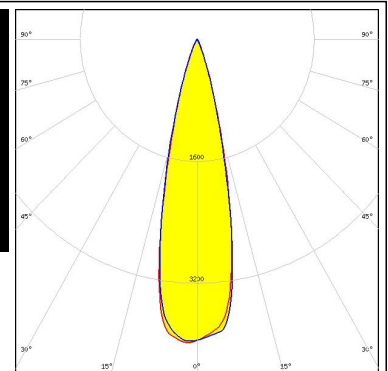
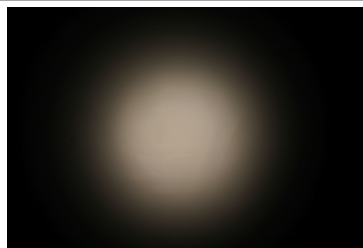

LED CXM-3  
Ordering code CP18738\_YASMEEN-50-M-C2-WHT  
FWHM / FWTM 25.0° / 41.0°  
Efficiency 92 %  
Peak intensity 3.9 cd/lm  
LEDs/each optic 1  
Light colour White  
Required components:  
F17435\_HEKLA-G2-C

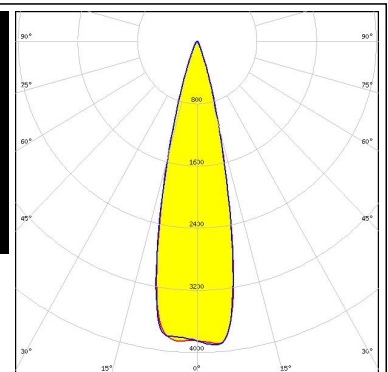
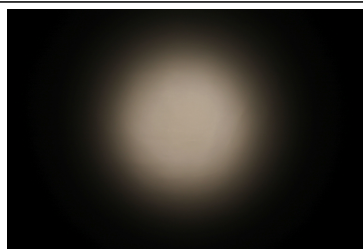

### OPTICAL RESULTS (MEASURED):



**LED** CXM-4  
**Ordering code** CP18724\_YASMEEN-50-M-C2  
**FWHM / FWTM** 24.0° / 42.0°  
**Efficiency** 85 %  
**Peak intensity** 4 cd/lm  
**LEDs/each optic** 1  
**Light colour** White  
**Required components:**  
 F17435\_HEKLA-G2-C

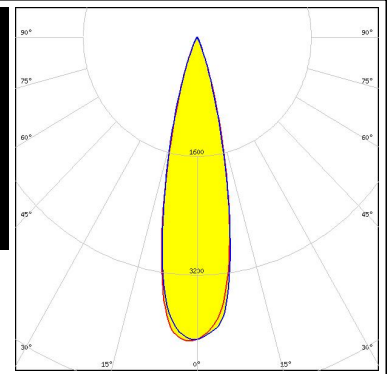
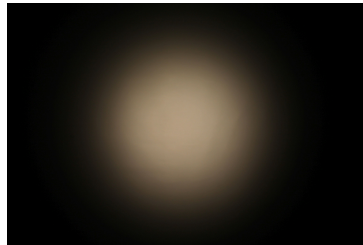

**LED** CXM-4  
**Ordering code** CP18738\_YASMEEN-50-M-C2-WHT  
**FWHM / FWTM** 25.0° / 42.0°  
**Efficiency** 92 %  
**Peak intensity** 4 cd/lm  
**LEDs/each optic** 1  
**Light colour** White  
**Required components:**  
 F17435\_HEKLA-G2-C

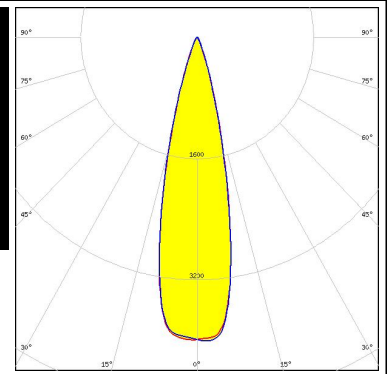

**LED** COB L-Type (LES 9)  
**Ordering code** CP18738\_YASMEEN-50-M-C2-WHT  
**FWHM / FWTM** 24.0° / 44.0°  
**Efficiency** 91 %  
**Peak intensity** 3.9 cd/lm  
**LEDs/each optic** 1  
**Light colour** White  
**Required components:**  
 F17437\_HEKLA-G2-H

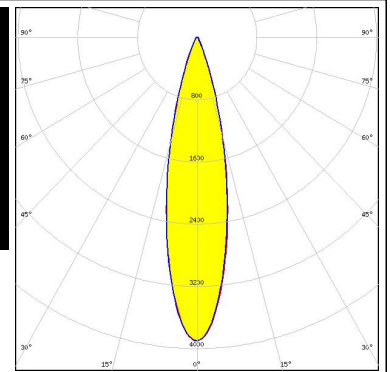
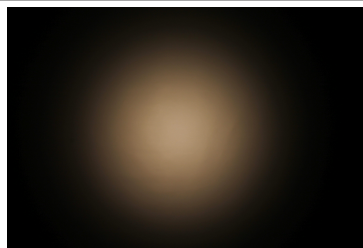

**LED** COB S-Type (LES 7)  
**Ordering code** CP18724\_YASMEEN-50-M-C2  
**FWHM / FWTM** 24.0° / 44.0°  
**Efficiency** 85 %  
**Peak intensity** 4 cd/lm  
**LEDs/each optic** 1  
**Light colour** White  
**Required components:**  
 F15848\_HEKLA-SOCKET-G

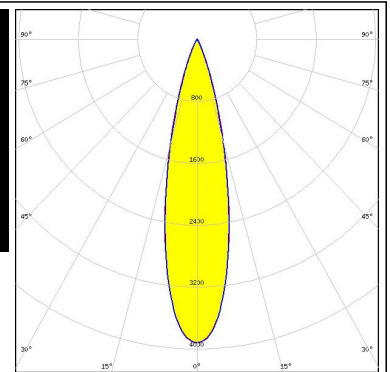
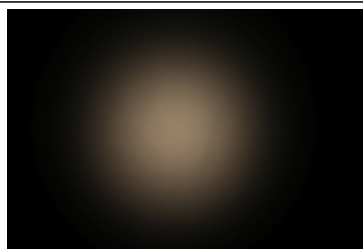

### OPTICAL RESULTS (MEASURED):



**LED** COB S-Type (LES 7)  
**Ordering code** CP18738\_YASMEEN-50-M-C2-WHT  
**FWHM / FWTM** 25.0° / 44.0°  
**Efficiency** 91 %  
**Peak intensity** 4 cd/lm  
**LEDs/each optic** 1  
**Light colour** White  
**Required components:**  
 F15848\_HEKLA-SOCKET-G

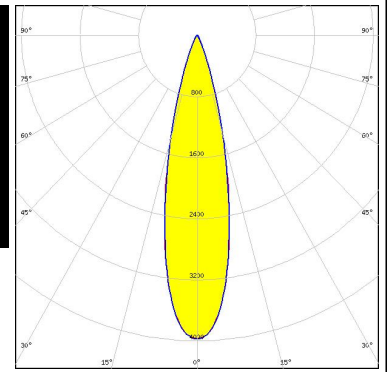
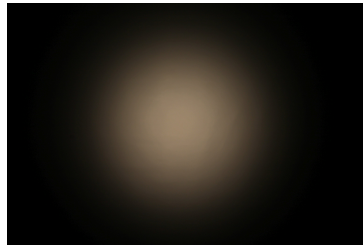

**LED** Fortimo SLM L09 CoB  
**Ordering code** CP18724\_YASMEEN-50-M-C2  
**FWHM / FWTM** 23.0° / 45.0°  
**Efficiency** 83 %  
**Peak intensity** 3.9 cd/lm  
**LEDs/each optic** 1  
**Light colour** White  
**Required components:**  
 F17437\_HEKLA-G2-H

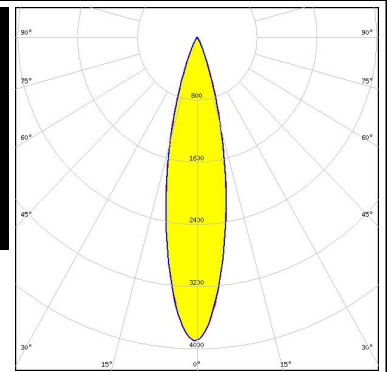
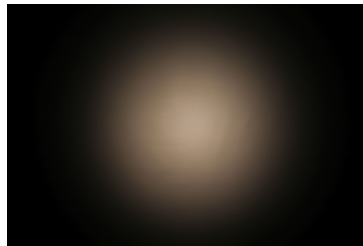

**LED** Fortimo SLM L09 CoB  
**Ordering code** CP18738\_YASMEEN-50-M-C2-WHT  
**FWHM / FWTM** 23.0° / 44.0°  
**Efficiency** 91 %  
**Peak intensity** 4 cd/lm  
**LEDs/each optic** 1  
**Light colour** White  
**Required components:**  
 F17437\_HEKLA-G2-H

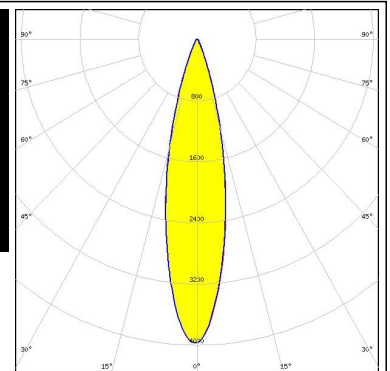
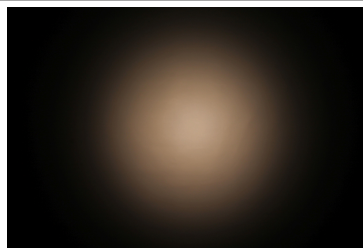

**LED** LC003D / LC006D / LC009D / LC013D  
**Ordering code** CP18724\_YASMEEN-50-M-C2  
**FWHM / FWTM** 24.0° / 46.0°  
**Efficiency** 84 %  
**Peak intensity** 3.7 cd/lm  
**LEDs/each optic** 1  
**Light colour** White  
**Required components:**  
 F17435\_HEKLA-G2-C

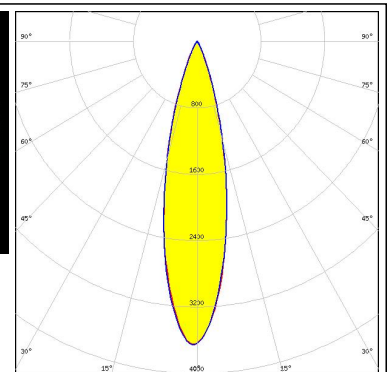
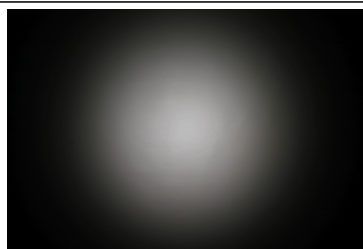



### OPTICAL RESULTS (MEASURED):

#### SAMSUNG

LED LC003D / LC006D / LC009D / LC013D  
Ordering code CP18738\_YASMEEN-50-M-C2-WHT  
FWHM / FWTM 24.0° / 46.0°  
Efficiency 91 %  
Peak intensity 3.7 cd/lm  
LEDs/each optic 1  
Light colour White  
Required components:  
F17435\_HEKLA-G2-C

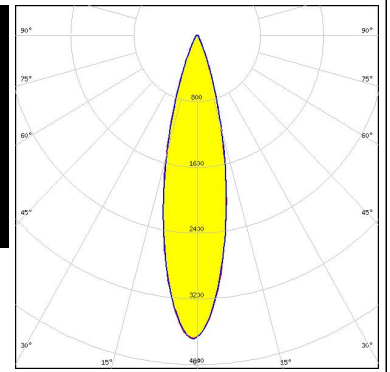

SEOUL SEMICONDUCTOR

LED MJT COB LES 6  
Ordering code CP18738\_YASMEEN-50-M-C2-WHT  
FWHM / FWTM 25.0° / 43.0°  
Efficiency 93 %  
Peak intensity 4 cd/lm  
LEDs/each optic 1  
Light colour White  
Required components:  
F17435\_HEKLA-G2-C

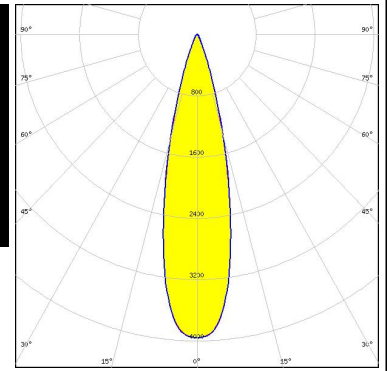
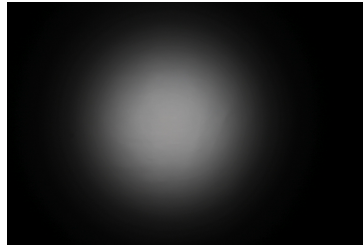

SEOUL SEMICONDUCTOR

LED MJT COB LES 6  
Ordering code CP18724\_YASMEEN-50-M-C2  
FWHM / FWTM 24.0° / 43.0°  
Efficiency 85 %  
Peak intensity 4 cd/lm  
LEDs/each optic 1  
Light colour White  
Required components:  
F17435\_HEKLA-G2-C

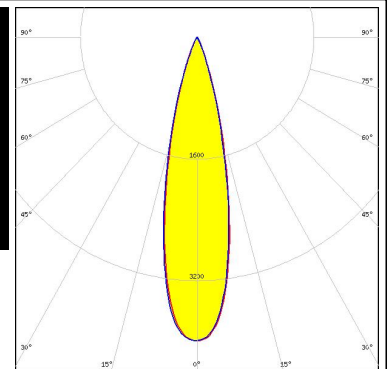

SEOUL SEMICONDUCTOR

LED MJT COB LES 9.8  
Ordering code CP18724\_YASMEEN-50-M-C2  
FWHM / FWTM 25.0° / 46.0°  
Efficiency 83 %  
Peak intensity 3.7 cd/lm  
LEDs/each optic 1  
Light colour White  
Required components:  
F17435\_HEKLA-G2-C

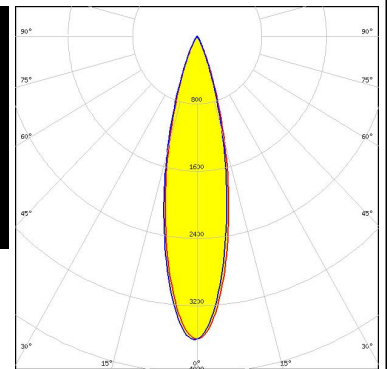

### OPTICAL RESULTS (MEASURED):

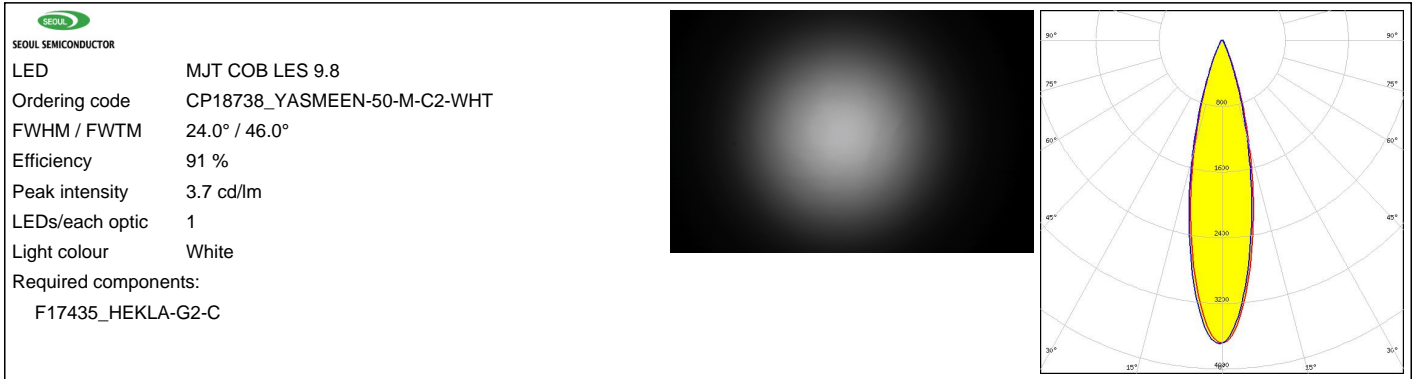

### OPTICAL RESULTS (SIMULATED):



**LED** V3 HD Gen 8  
**Ordering code** CP18724\_YASMEEN-50-M-C2  
**FWHM / FWTM** 28.0° / 42.0°  
**Efficiency** 87 %  
**Peak intensity** 4 cd/lm  
**LEDs/each optic** 1  
**Light colour** White  
**Required components:**  
 F15253\_HEKLA-SOCKET-A

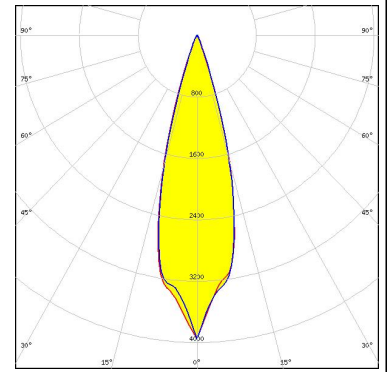

**LED** V3 HD Gen 8 FC  
**Ordering code** CP18724\_YASMEEN-50-M-C2  
**FWHM / FWTM** 32.0° / 44.0°  
**Efficiency** 87 %  
**Peak intensity** 3.3 cd/lm  
**LEDs/each optic** 1  
**Light colour** White  
**Required components:**  
 F15255\_HEKLA-SOCKET-C

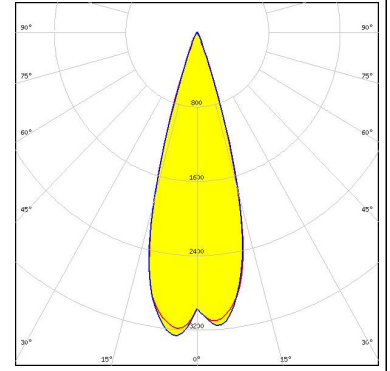

**LED** V4 HD Gen 8  
**Ordering code** CP18724\_YASMEEN-50-M-C2  
**FWHM / FWTM** 28.0° / 42.0°  
**Efficiency** 87 %  
**Peak intensity** 4 cd/lm  
**LEDs/each optic** 1  
**Light colour** White  
**Required components:**  
 F15253\_HEKLA-SOCKET-A

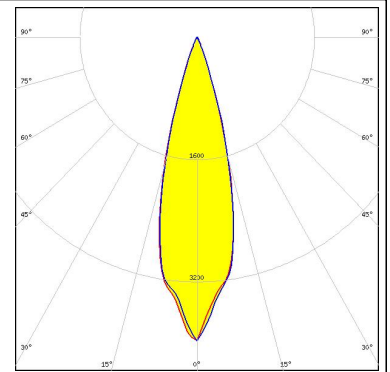

**LED** V6 Gen 8-9  
**Ordering code** CP18724\_YASMEEN-50-M-C2  
**FWHM / FWTM** 27.0° / 44.0°  
**Efficiency** 86 %  
**Peak intensity** 3.8 cd/lm  
**LEDs/each optic** 1  
**Light colour** White  
**Required components:**  
 F15253\_HEKLA-SOCKET-A

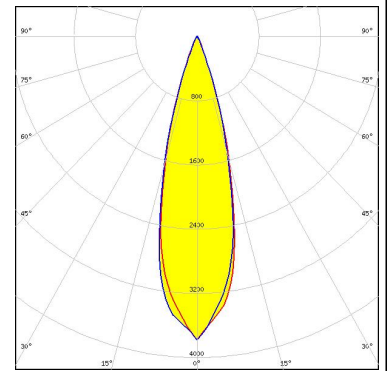

### OPTICAL RESULTS (SIMULATED):

bridgelux.

LED V6 HD Gen 8  
Ordering code CP18724\_YASMEEN-50-M-C2  
FWHM / FWTM 28.0° / 44.0°  
Efficiency 86 %  
Peak intensity 3.6 cd/lm  
LEDs/each optic 1  
Light colour White  
Required components:  
F15255\_HEKLA-SOCKET-C

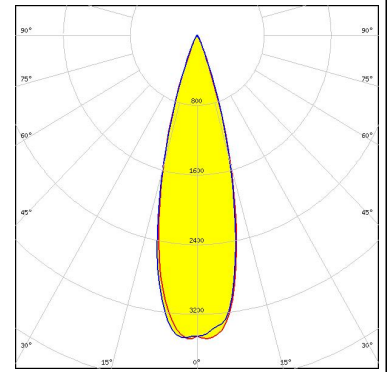

bridgelux.

LED V9 HD Gen 8  
Ordering code CP18724\_YASMEEN-50-M-C2  
FWHM / FWTM 28.0° / 46.0°  
Efficiency 84 %  
Peak intensity 3.5 cd/lm  
LEDs/each optic 1  
Light colour White  
Required components:  
F15859\_HEKLA-SOCKET-I

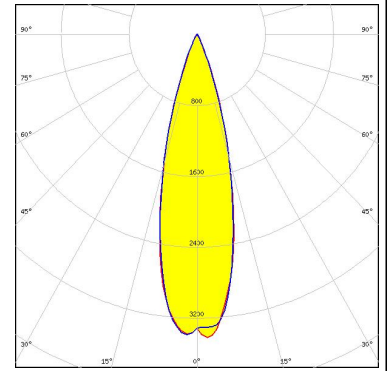

bridgelux.

LED Vero SE 13  
Ordering code CP18724\_YASMEEN-50-M-C2  
FWHM / FWTM 26.0° / 48.0°  
Efficiency 73 %  
Peak intensity 2.9 cd/lm  
LEDs/each optic 1  
Light colour White  
Required components:  
C16142\_HEKLA-SOCKET-K

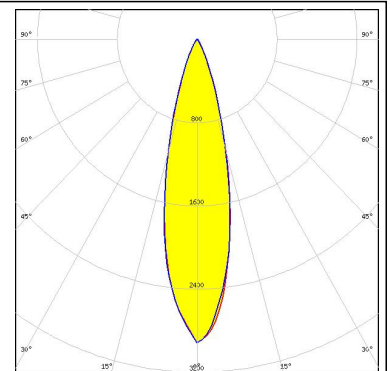

bridgelux.

LED VERO13  
Ordering code CP18724\_YASMEEN-50-M-C2  
FWHM / FWTM 30.0° / 53.0°  
Efficiency 84 %  
Peak intensity 2.8 cd/lm  
LEDs/each optic 1  
Light colour White  
Required components:  
C16142\_HEKLA-SOCKET-K

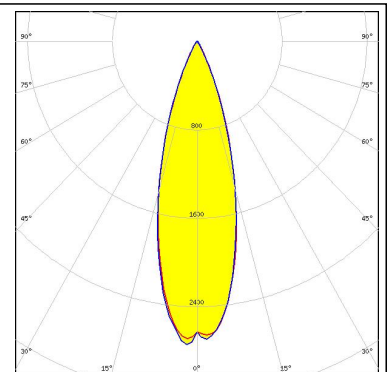

### OPTICAL RESULTS (SIMULATED):

bridgelux.

LED Vesta DTW 6mm  
 Ordering code CP18724\_YASMEEN-50-M-C2  
 FWHM / FWTM 28.0° / 44.0°  
 Efficiency 85 %  
 Peak intensity 3.6 cd/lm  
 LEDs/each optic 1  
 Light colour White  
 Required components:  
 Bender Wirth: 652b Hekla

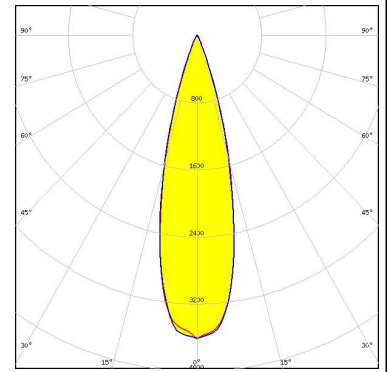

bridgelux.

LED Vesta SE 13mm TW  
 Ordering code CP18724\_YASMEEN-50-M-C2  
 FWHM / FWTM 28.0° / 52.0°  
 Efficiency 73 %  
 Peak intensity 2.6 cd/lm  
 LEDs/each optic 1  
 Light colour Tunable White  
 Required components:  
 C16142\_HEKLA-SOCKET-K

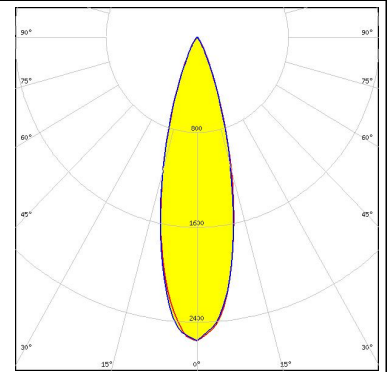

bridgelux.

LED Vesta TW 13mm (18W) DP  
 Ordering code CP18724\_YASMEEN-50-M-C2  
 FWHM / FWTM 28.0° / 50.0°  
 Efficiency 79 %  
 Peak intensity 2.9 cd/lm  
 LEDs/each optic 1  
 Light colour Tunable White  
 Required components:  
 C16142\_HEKLA-SOCKET-K  
 Bender Wirth: 492 Typ L8

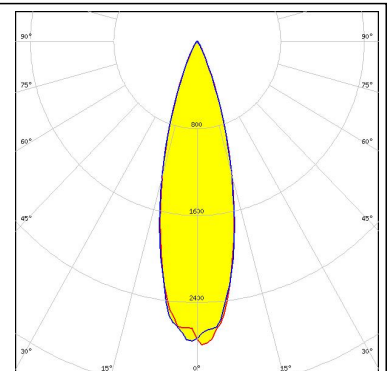

bridgelux.

LED Vesta TW 15mm DP  
 Ordering code CP18724\_YASMEEN-50-M-C2  
 FWHM / FWTM 32.0° / 54.0°  
 Efficiency 77 %  
 Peak intensity 2.3 cd/lm  
 LEDs/each optic 1  
 Light colour Tunable White  
 Required components:  
 C16142\_HEKLA-SOCKET-K  
 Bender Wirth: 482 Typ L8

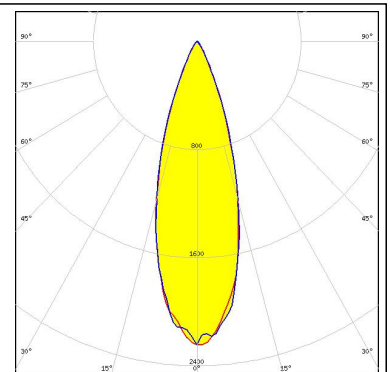

### OPTICAL RESULTS (SIMULATED):



LED Vesta TW 9mm (9W) DP  
Ordering code CP18724\_YASMEEN-50-M-C2  
FWHM / FWTM 32.0° / 53.0°  
Efficiency 86 %  
Peak intensity 2.7 cd/lm  
LEDs/each optic 1  
Light colour Tunable White  
Required components:  
C16142\_HEKLA-SOCKET-K  
Bender Wirth: 489 Typ L8

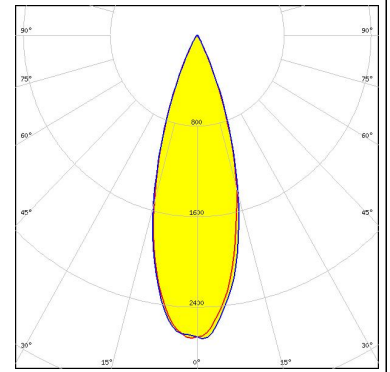

### CITIZEN

LED CLU712/713  
Ordering code CP18724\_YASMEEN-50-M-C2  
FWHM / FWTM 26.0° / 46.0°  
Efficiency 83 %  
Peak intensity 3.6 cd/lm  
LEDs/each optic 1  
Light colour White  
Required components:  
F17438\_HEKLA-G2-I

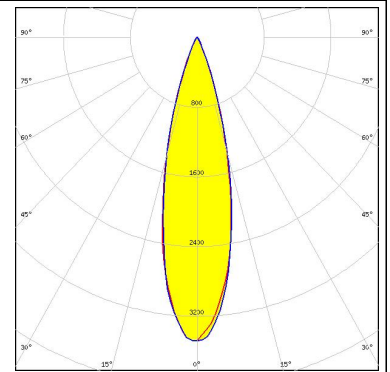

LED CHA0304  
Ordering code CP18724\_YASMEEN-50-M-C2  
FWHM / FWTM 30.0° / 44.0°  
Efficiency 85 %  
Peak intensity 3.4 cd/lm  
LEDs/each optic 1  
Light colour White  
Required components:  
F17435\_HEKLA-G2-C

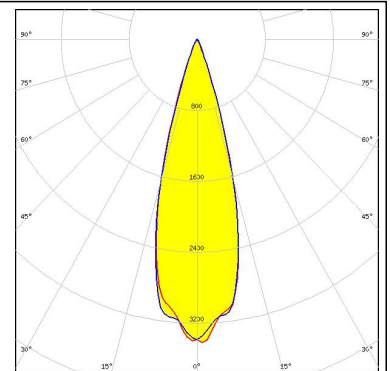

LED CHA0410  
Ordering code CP18724\_YASMEEN-50-M-C2  
FWHM / FWTM 28.0° / 44.0°  
Efficiency 85 %  
Peak intensity 3.6 cd/lm  
LEDs/each optic 1  
Light colour White  
Required components:  
F17435\_HEKLA-G2-C

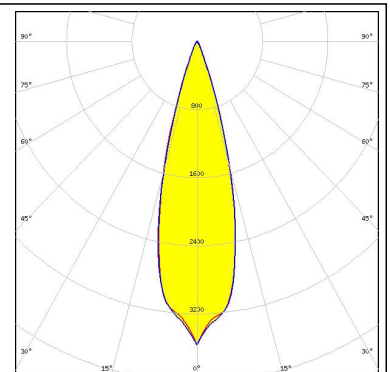

### OPTICAL RESULTS (SIMULATED):



LED CHA0612  
Ordering code CP18724\_YASMEEN-50-M-C2  
FWHM / FWTM 28.0° / 44.0°  
Efficiency 84 %  
Peak intensity 3.4 cd/lm  
LEDs/each optic 1  
Light colour White  
Required components:  
F17435\_HEKLA-G2-C

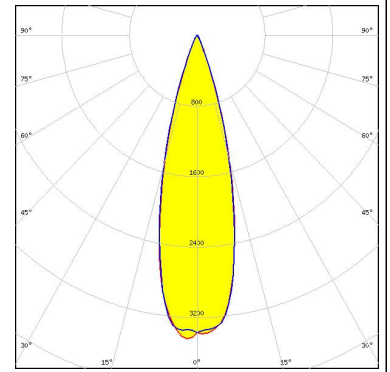

LED LUXEON CX Plus CoB L08 (Gen2)  
Ordering code CP18724\_YASMEEN-50-M-C2  
FWHM / FWTM 32.0° / 56.0°  
Efficiency 80 %  
Peak intensity 2.4 cd/lm  
LEDs/each optic 1  
Light colour White  
Required components:  
Bender Wirth: 637a Hekla

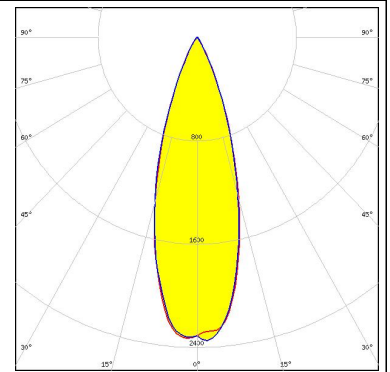

LED LUXEON CoB 1202/1203  
Ordering code CP18724\_YASMEEN-50-M-C2  
FWHM / FWTM 24.0° / 44.0°  
Efficiency 84 %  
Peak intensity 4 cd/lm  
LEDs/each optic 1  
Light colour White  
Required components:  
F15858\_HEKLA-SOCKET-H

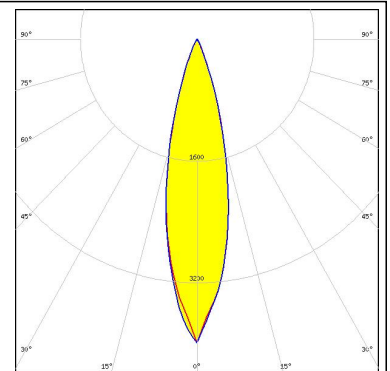

LED LUXEON CoB 1202HD  
Ordering code CP18724\_YASMEEN-50-M-C2  
FWHM / FWTM 28.0° / 44.0°  
Efficiency 86 %  
Peak intensity 3.7 cd/lm  
LEDs/each optic 1  
Light colour White  
Required components:  
F15848\_HEKLA-SOCKET-G

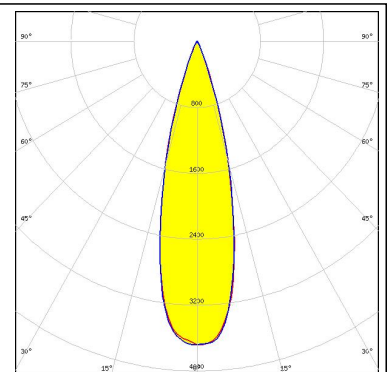

### OPTICAL RESULTS (SIMULATED):

#### LUMILEDS

LED LUXEON CoB 1204/1205  
Ordering code CP18724\_YASMEEN-50-M-C2  
FWHM / FWTM 28.0° / 50.0°  
Efficiency 81 %  
Peak intensity 2.9 cd/lm  
LEDs/each optic 1  
Light colour White  
Required components:  
Bender Wirth: 632a Hekla XL

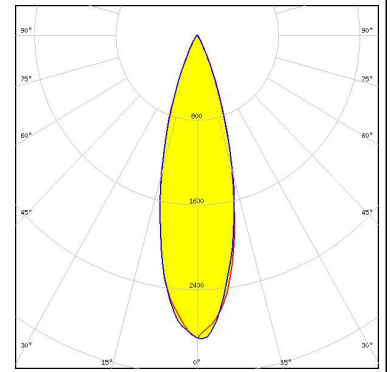

#### LUMILEDS

LED LUXEON CoB 1205HD  
Ordering code CP18724\_YASMEEN-50-M-C2  
FWHM / FWTM 26.0° / 48.0°  
Efficiency 83 %  
Peak intensity 3.4 cd/lm  
LEDs/each optic 1  
Light colour White  
Required components:  
F15858\_HEKLA-SOCKET-H

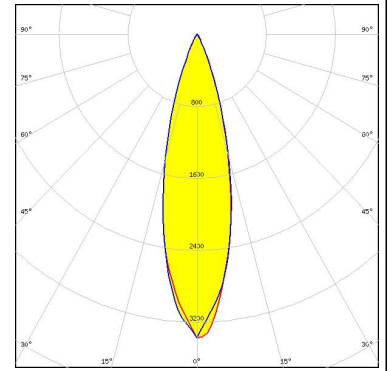

#### LUMILEDS

LED LUXEON CoB 1208  
Ordering code CP18724\_YASMEEN-50-M-C2  
FWHM / FWTM 30.0° / 54.0°  
Efficiency 80 %  
Peak intensity 2.5 cd/lm  
LEDs/each optic 1  
Light colour White  
Required components:  
Bender Wirth: 632a Hekla XL

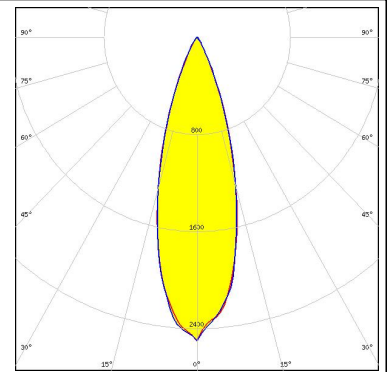

#### LUMILEDS

LED LUXEON CX Plus CoB - HD S01H4  
Ordering code CP18731\_YASMEEN-50-M-B2  
FWHM / FWTM 28.0° / 44.0°  
Efficiency 86 %  
Peak intensity 3.6 cd/lm  
LEDs/each optic 1  
Light colour White  
Required components:  
Bender Wirth: 634c Bayonet35L

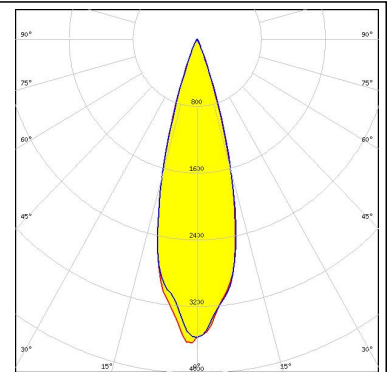



### OPTICAL RESULTS (SIMULATED):

#### LUMILEDS

LED LUXEON CX Plus CoB - HD S02H6  
 Ordering code CP18731\_YASMEEN-50-M-B2  
 FWHM / FWTM 28.0° / 46.0°  
 Efficiency 85 %  
 Peak intensity 3.5 cd/lm  
 LEDs/each optic 1  
 Light colour White  
 Required components:  
 Bender Wirth: 634c Bayonet35L

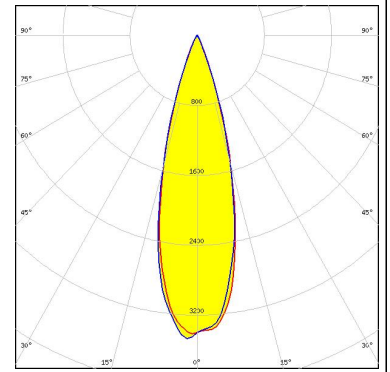

#### LUMILEDS

LED LUXEON CX Plus CoB - HD S04H9  
 Ordering code CP18731\_YASMEEN-50-M-B2  
 FWHM / FWTM 27.0° / 48.0°  
 Efficiency 84 %  
 Peak intensity 3.5 cd/lm  
 LEDs/each optic 1  
 Light colour White  
 Required components:  
 Bender Wirth: 634a Bayonet35L

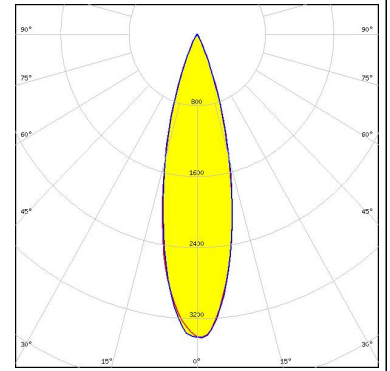

#### LUMILEDS

LED LUXEON CX Plus CoB L04 / L05 (Gen2)  
 Ordering code CP18724\_YASMEEN-50-M-C2  
 FWHM / FWTM 28.0° / 50.0°  
 Efficiency 82 %  
 Peak intensity 3 cd/lm  
 LEDs/each optic 1  
 Light colour White  
 Required components:  
 F15254\_HEKLA-SOCKET-B

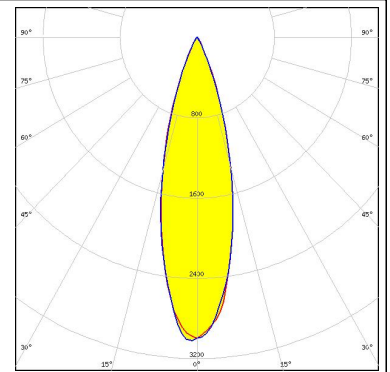

#### LUMILEDS

LED LUXEON CX Plus CoB M02 / M03 (Gen2)  
 Ordering code CP18724\_YASMEEN-50-M-C2  
 FWHM / FWTM 26.0° / 46.0°  
 Efficiency 85 %  
 Peak intensity 3.6 cd/lm  
 LEDs/each optic 1  
 Light colour White  
 Required components:  
 F15256\_HEKLA-SOCKET-D

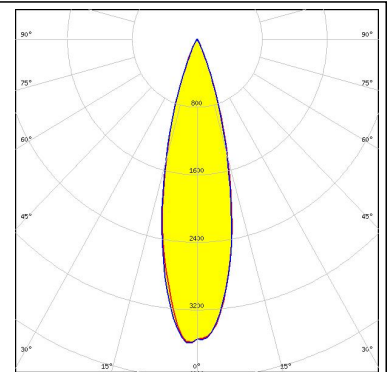

### OPTICAL RESULTS (SIMULATED):



LED LUXEON CX Plus CoB S01 (Gen2)  
Ordering code CP18724\_YASMEEN-50-M-C2  
FWHM / FWTM 28.0° / 44.0°  
Efficiency 86 %  
Peak intensity 3.7 cd/lm  
LEDs/each optic 1  
Light colour White  
Required components:  
F15956\_HEKLA-SOCKET-J

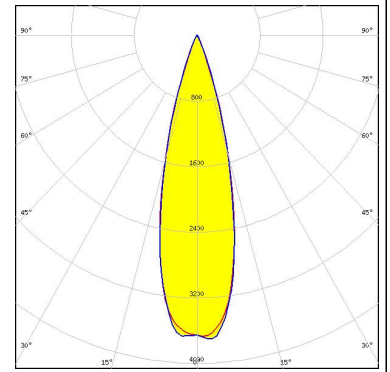

LED CHM-9 XH (19x19)  
Ordering code CP18724\_YASMEEN-50-M-C2  
FWHM / FWTM 26.0° / 44.0°  
Efficiency 83 %  
Peak intensity 3.8 cd/lm  
LEDs/each optic 1  
Light colour White  
Required components:  
F15859\_HEKLA-SOCKET-I

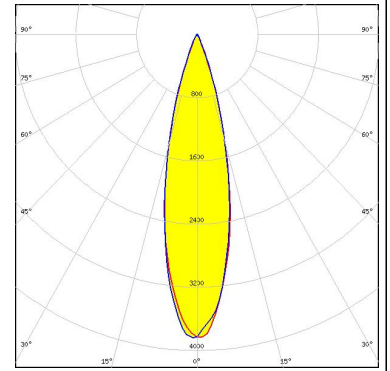

LED CTM-6 (Tunable White) Gen2  
Ordering code CP18724\_YASMEEN-50-M-C2  
FWHM / FWTM 26.0° / 44.0°  
Efficiency 84 %  
Peak intensity 3.8 cd/lm  
LEDs/each optic 1  
Light colour Tunable White  
Required components:  
C16142\_HEKLA-SOCKET-K  
Bender Wirth: 495 Typ L8

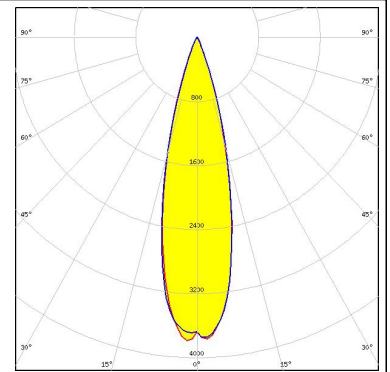

LED CTM-9 (Tunable White) Gen2  
Ordering code CP18724\_YASMEEN-50-M-C2  
FWHM / FWTM 26.0° / 44.0°  
Efficiency 82 %  
Peak intensity 3.8 cd/lm  
LEDs/each optic 1  
Light colour Tunable White  
Required components:  
C16142\_HEKLA-SOCKET-K  
Bender Wirth: 495 Typ L8

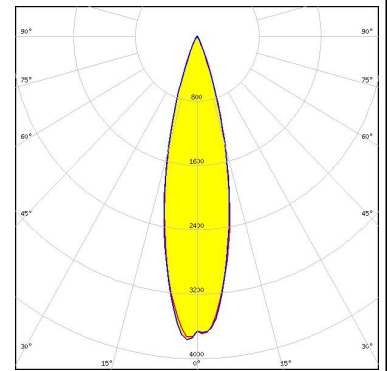

### OPTICAL RESULTS (SIMULATED):



LED CxM-6 (13.5x13.5)  
Ordering code CP18731\_YASMEEN-50-M-B2  
FWHM / FWTM 26.0° / 42.0°  
Efficiency 86 %  
Peak intensity 3.9 cd/lm  
LEDs/each optic 1  
Light colour White  
Required components:  
BJB: 47.360.1020

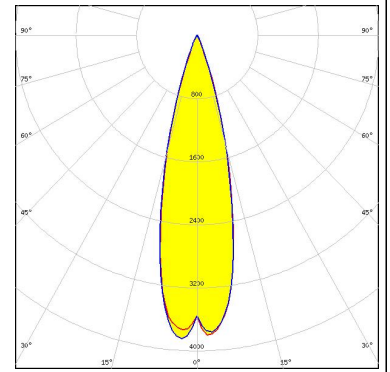

LED COB L-Type (LES 11)  
Ordering code CP18724\_YASMEEN-50-M-C2  
FWHM / FWTM 28.0° / 50.0°  
Efficiency 83 %  
Peak intensity 3.2 cd/lm  
LEDs/each optic 1  
Light colour White  
Required components:  
F15858\_HEKLA-SOCKET-H

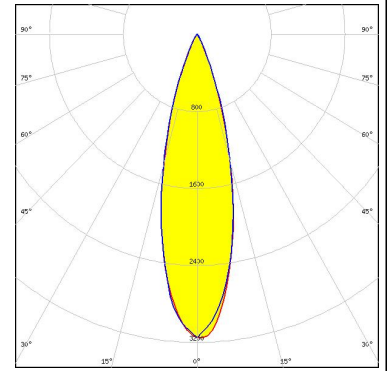

LED COB S-Type (LES 6)  
Ordering code CP18731\_YASMEEN-50-M-B2  
FWHM / FWTM 28.0° / 44.0°  
Efficiency 85 %  
Peak intensity 3.5 cd/lm  
LEDs/each optic 1  
Light colour White  
Required components:  
Bender Wirth: 652a Bayonet35L

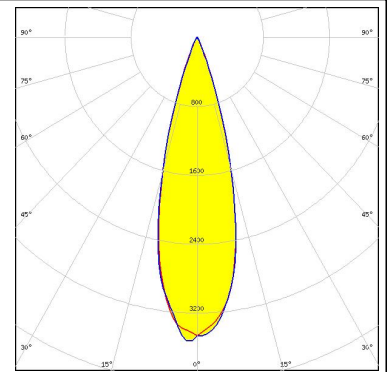

LED COB S-Type (LES 7)  
Ordering code CP18731\_YASMEEN-50-M-B2  
FWHM / FWTM 28.0° / 46.0°  
Efficiency 85 %  
Peak intensity 3.5 cd/lm  
LEDs/each optic 1  
Light colour White  
Required components:  
Bender Wirth: 652a Bayonet35L

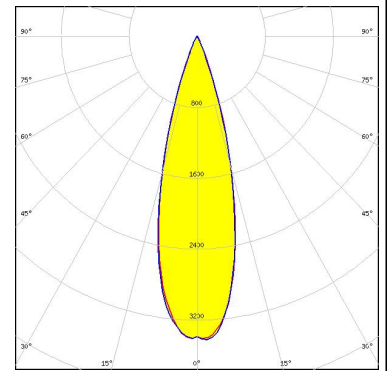

### OPTICAL RESULTS (SIMULATED):



**LED** COB T-Type  
**Ordering code** CP18731\_YASMEEN-50-M-B2  
**FWHM / FWTM** 28.0° / 45.0°  
**Efficiency** 85 %  
**Peak intensity** 3.5 cd/lm  
**LEDs/each optic** 1  
**Light colour** White  
**Required components:**  
 Bender Wirth: 652a Bayonet35L

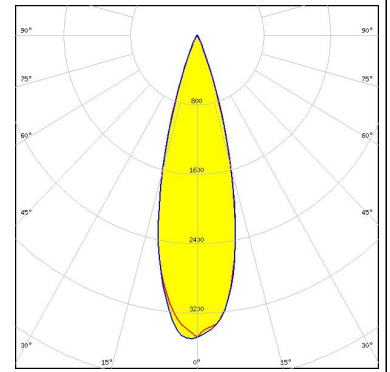

**LED** NJCWL024Z-V1MT: COB L-Type Tunable White  
**Ordering code** CP18724\_YASMEEN-50-M-C2  
**FWHM / FWTM** 26.0° / 42.0°  
**Efficiency** 83 %  
**Peak intensity** 3.9 cd/lm  
**LEDs/each optic** 1  
**Light colour** Tunable White  
**Required components:**  
 C16142\_HEKLA-SOCKET-K  
 Bender Wirth: 497 Typ L8 HV

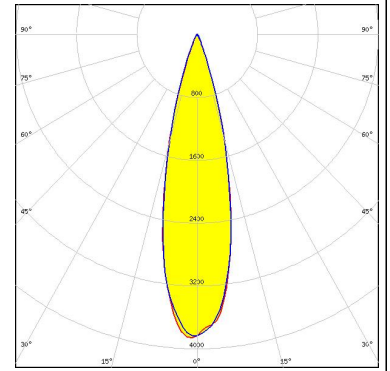

**LED** NJNWS012Z-V1MT: COB S-Type Tunable White  
**Ordering code** CP18724\_YASMEEN-50-M-C2  
**FWHM / FWTM** 26.0° / 42.0°  
**Efficiency** 84 %  
**Peak intensity** 4 cd/lm  
**LEDs/each optic** 1  
**Light colour** Tunable White  
**Required components:**  
 C16142\_HEKLA-SOCKET-K  
 Bender Wirth: 495 Typ L8 HV

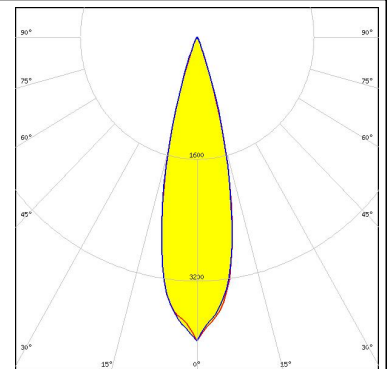

**LED** NVCWJ024Z-V1MT: COB J-Type Tunable White  
**Ordering code** CP18724\_YASMEEN-50-M-C2  
**FWHM / FWTM** 26.0° / 46.0°  
**Efficiency** 81 %  
**Peak intensity** 3.4 cd/lm  
**LEDs/each optic** 1  
**Light colour** Tunable White  
**Required components:**  
 C16142\_HEKLA-SOCKET-K  
 Bender Wirth: 498 Typ L8 HV

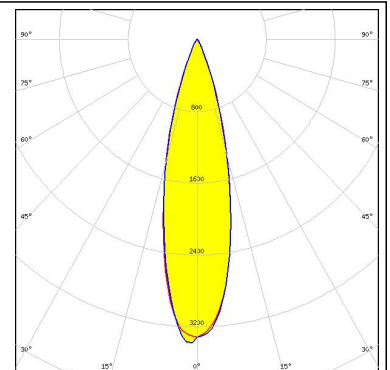

### OPTICAL RESULTS (SIMULATED):

#### SAMSUNG

LED LC010C G2  
Ordering code CP18731\_YASMEEN-50-M-B2  
FWHM / FWTM 26.0° / 42.0°  
Efficiency 86 %  
Peak intensity 3.9 cd/lm  
LEDs/each optic 1  
Light colour White  
Required components:  
BJB: 47.360.1020

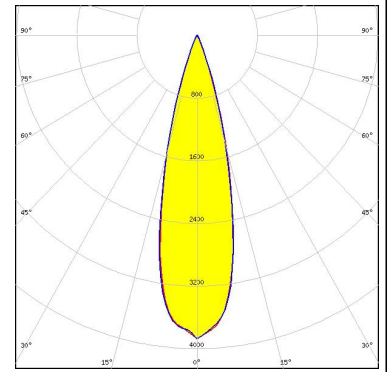

#### SAMSUNG

LED LC010T (Tunable White)  
Ordering code CP18724\_YASMEEN-50-M-C2  
FWHM / FWTM 26.0° / 44.0°  
Efficiency 83 %  
Peak intensity 3.8 cd/lm  
LEDs/each optic 1  
Light colour Tunable White  
Required components:  
C16142\_HEKLA-SOCKET-K  
Bender Wirth: 501 Typ L8

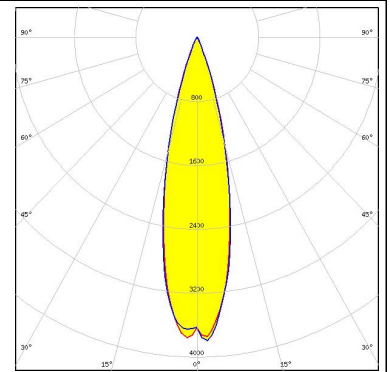

#### SAMSUNG

LED LC016D / LC019D / LC026D / LC033D  
Ordering code CP18731\_YASMEEN-50-M-B2  
FWHM / FWTM 34.0° / 56.0°  
Efficiency 77 %  
Peak intensity 2.2 cd/lm  
LEDs/each optic 1  
Light colour White  
Required components:  
BJB: 47.360.1010

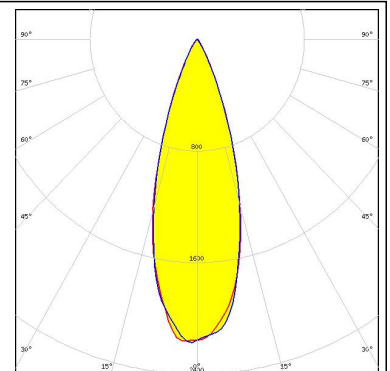

#### SAMSUNG

LED LC020C G2  
Ordering code CP18731\_YASMEEN-50-M-B2  
FWHM / FWTM 26.0° / 44.0°  
Efficiency 83 %  
Peak intensity 3.7 cd/lm  
LEDs/each optic 1  
Light colour White  
Required components:  
BJB: 47.360.1010

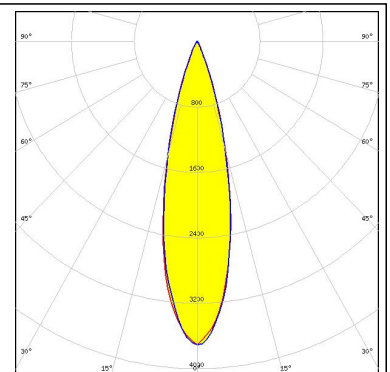

### OPTICAL RESULTS (SIMULATED):

#### SAMSUNG

LED LC030C/040C G2  
Ordering code CP18731\_YASMEEN-50-M-B2  
FWHM / FWTM 28.0° / 49.0°  
Efficiency 81 %  
Peak intensity 3.1 cd/lm  
LEDs/each optic 1  
Light colour White  
Required components:  
BJB: 47.360.1010

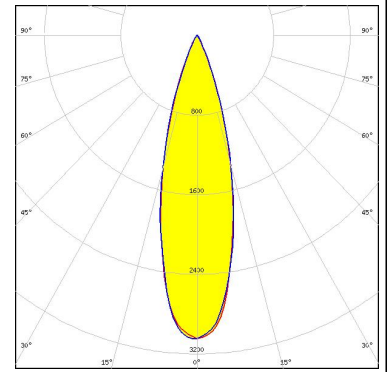

LED MJT COB LES 14.5  
Ordering code CP18724\_YASMEEN-50-M-C2  
FWHM / FWTM 32.0° / 55.0°  
Efficiency 80 %  
Peak intensity 2.4 cd/lm  
LEDs/each optic 1  
Light colour White  
Required components:  
F15859\_HEKLA-SOCKET-I

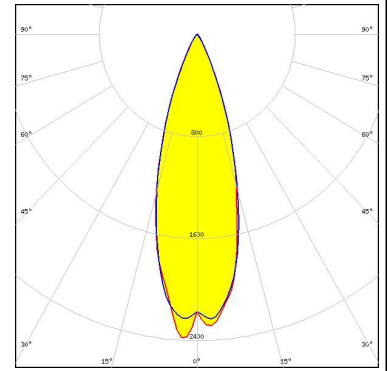

#### TRIDONIC

LED SLE G7 LES13  
Ordering code CP18724\_YASMEEN-50-M-C2  
FWHM / FWTM 30.0° / 52.0°  
Efficiency 80 %  
Peak intensity 2.7 cd/lm  
LEDs/each optic 1  
Light colour White  
Required components:  
F17438\_HEKLA-G2-I

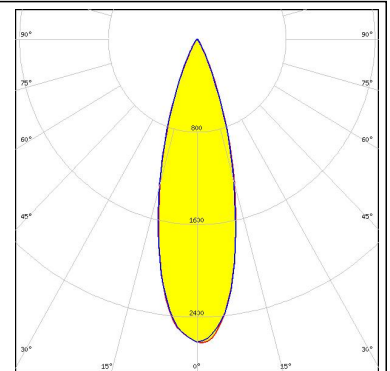

### GENERAL INFORMATION:

NOTE: The typical beam angle will be changed by different color, chip size and chip position tolerance. The typical total beam angle is the full angle measured where the luminous intensity is half of the peak value.

Due to use of high power COB's with this product, special attention to proper thermal design is highly recommended. LEDiL has no liability for direct, indirect or consecutive damages arising from the LEDiL products being used outside of the recommended temperature range.

### MATERIALS:

As part of our continuous research and improvement processes, and to ensure the best possible quality and availability of our products, LEDiL reserves the right to change material grades without notice.

### PRODUCT DATA USER AGREEMENT AND DISCLAIMER:

The measured data in the provided downloadable LEDiL Product Datasheets and Mechanical 2D-Drawings is rounded and provided as reference for planning. LEDiL Oy's optical specifications have been verified by conducting performance testing of the products in accordance with the company's quality system. The reported data are averaged results of multiple measurements with typical variation. LEDiL Oy reserves the right to without prior notification make changes and improvements to its products.

LEDiL Oy assumes neither warranty, nor guarantee nor any other liability of any kind for the contents and correctness of the provided data. The provided data has been generated with highest diligence but the provided data may in reality not represent the complete possible variation range of all intrinsic parameters. Therefore, in certain cases a deviation from the provided data could occur.

LEDiL Oy reserves the right to undertake technical changes of its products without further notification which could lead to changes in the provided data. LEDiL Oy assumes no liability of any kind for the possible deviation from any provided data or any other damage resulting from the usage of the provided data.

The user agrees to this disclaimer and user agreement with the download or usage of the provided files.

#### LEDiL Oy

Joensuunkatu 13  
FI-24240 SALO  
Finland

#### LEDiL Inc.

228 West Page Street  
Suite D  
Sycamore IL 60178  
USA

#### Ledil Optics Technology (Shenzhen) Co., Ltd.

# 405 , Block B  
Casic Motor Building  
Shenzhen 518057  
P.R.CHINA

#### Local sales and technical support

[www.ledil.com/  
where\\_to\\_buy](http://www.ledil.com/where_to_buy)

#### Shipping locations

Salo, Finland  
Hong Kong, China

#### Distribution Partners

[www.ledil.com/  
where\\_to\\_buy](http://www.ledil.com/where_to_buy)