

YASMEEN-50-WW

~60° wide beam

SPECIFICATION:

Dimensions	Ø 49.9 mm
Height	28.1 mm
Fastening	socket
ROHS compliant	yes ⓘ

MATERIALS:

Component	Type	Material	Colour	Finish
YASMEEN-50-WW	Single lens	PMMA	clear	
YASMEEN-50-HLD2-C	Holder C	PC	black	
YASMEEN-50-HLD2-B	Holder B	PC	black	
YASMEEN-50-HLD2-C-WHT	Holder C	PC	white	
YASMEEN-50-HLD2-B-WHT	Holder B	PC	white	



ORDERING INFORMATION:

Component	Qty in box	MOQ	MPQ	Box weight (kg)
C17237_YASMEEN-50-WW	252	112	28	7.9
Assembly				
CP18747_YASMEEN-50-WW-B2-WHT	252	112	28	9.3
CP18740_YASMEEN-50-WW-C2-WHT	252	112	28	9.1
CP18733_YASMEEN-50-WW-B2	252	112	28	9.3
CP18726_YASMEEN-50-WW-C2	252	112	28	9.1

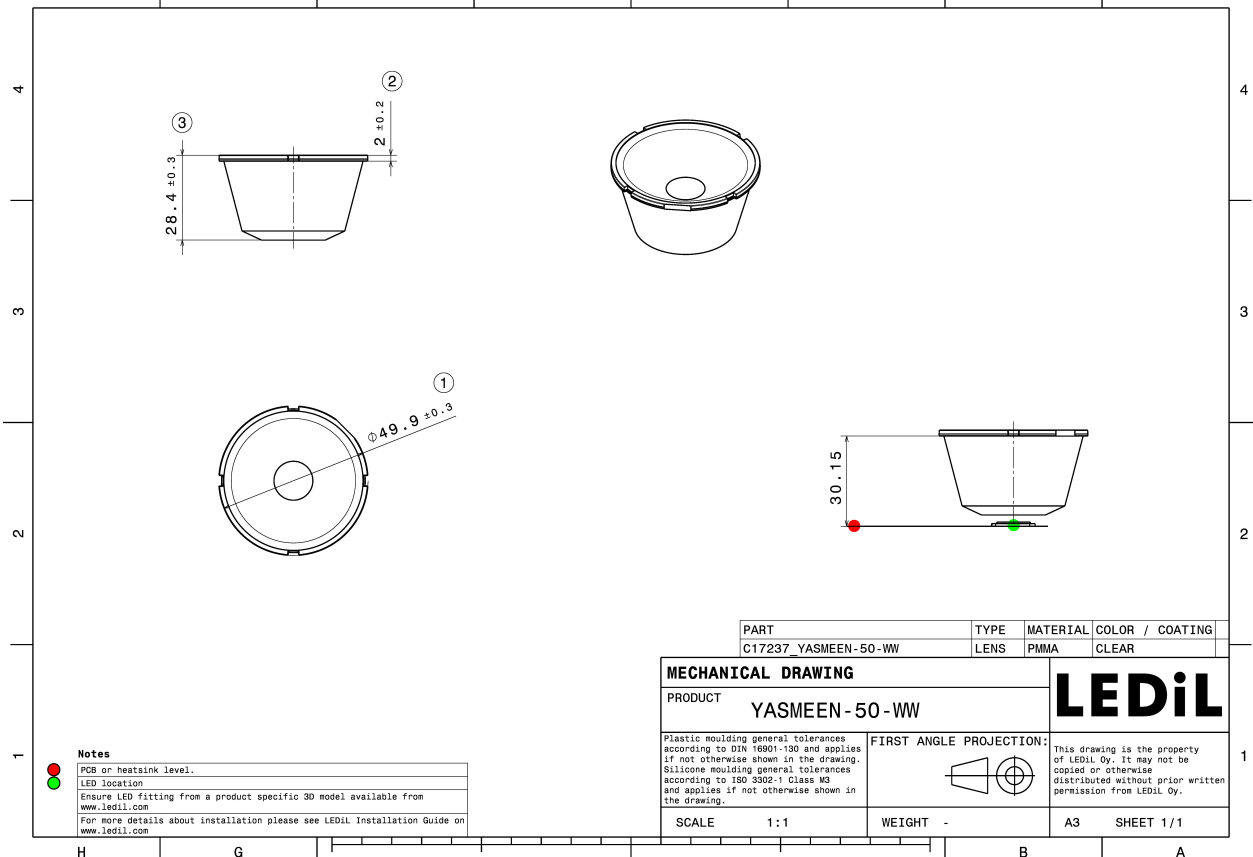
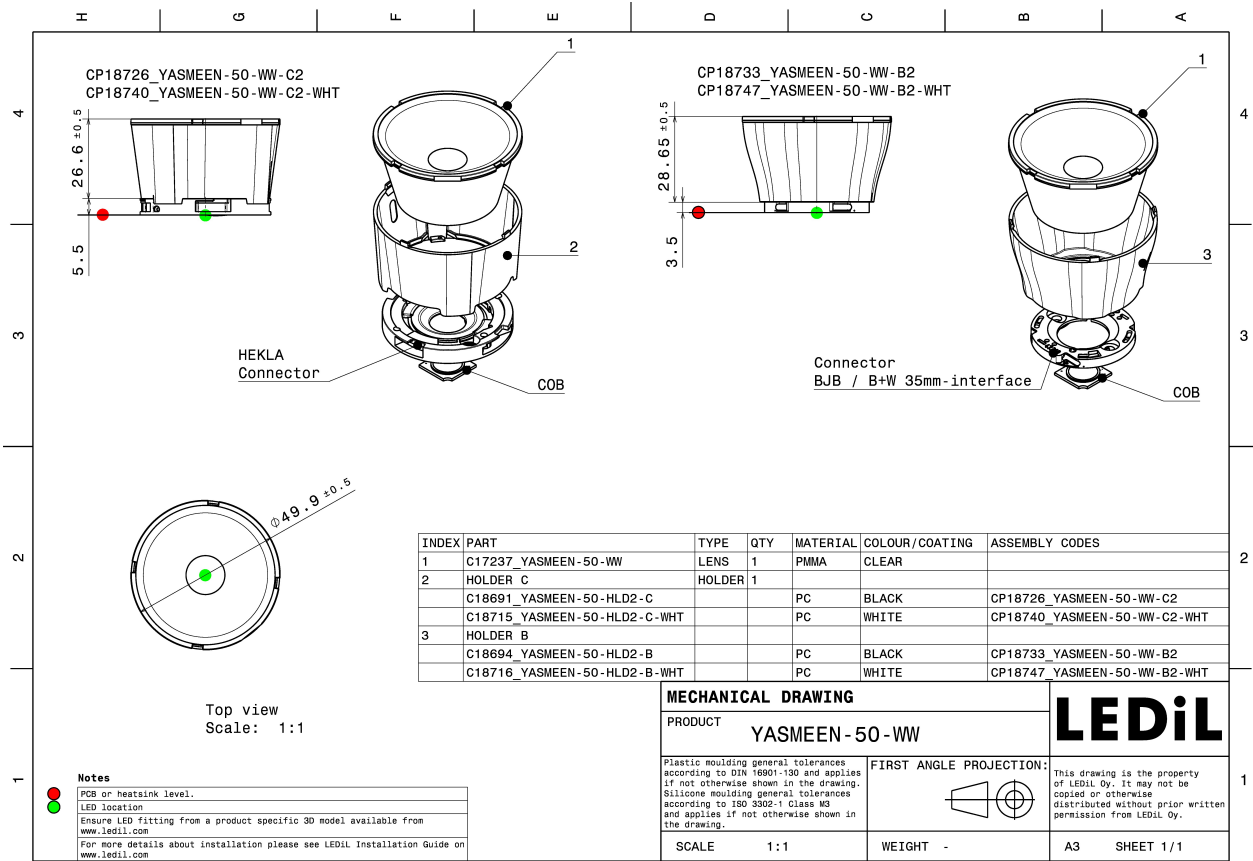

See also our general installation guide: www.ledil.com/installation_guide

OPTICAL RESULTS (MEASURED):



OPTICAL RESULTS (MEASURED):



OPTICAL RESULTS (MEASURED):



OPTICAL RESULTS (MEASURED):

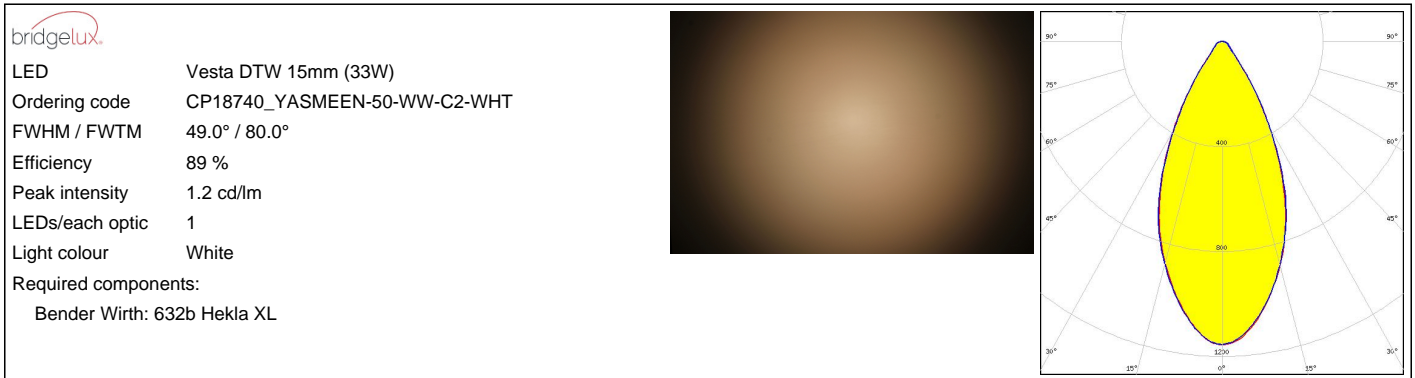
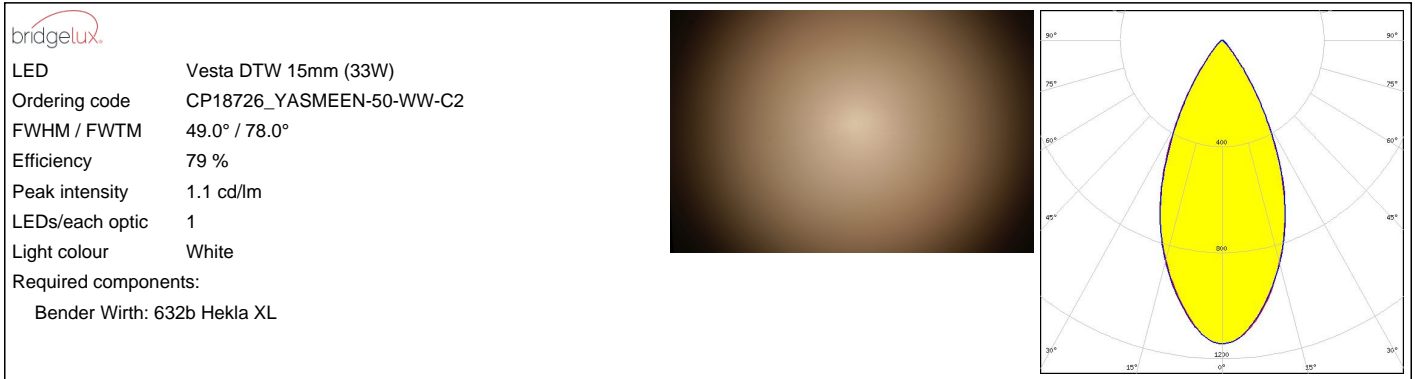

OPTICAL RESULTS (MEASURED):

CITIZEN

LED CLL02x/CLU02x (LES10)
 Ordering code CP18726_YASMEEN-50-WW-C2
 FWHM / FWTM 54.0° / 76.0°
 Efficiency 83 %
 Peak intensity 1.1 cd/lm
 LEDs/each optic 1
 Light colour White
 Required components:
 F17435_HEKLA-G2-C

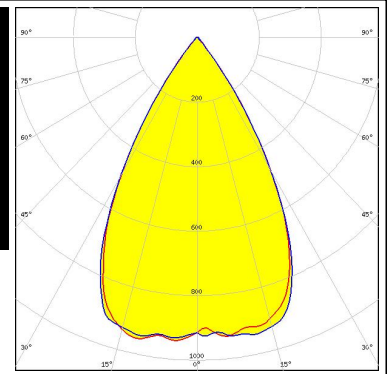

CITIZEN

LED CLL02x/CLU02x (LES10)
 Ordering code CP18740_YASMEEN-50-WW-C2-WHT
 FWHM / FWTM 54.0° / 78.0°
 Efficiency 91 %
 Peak intensity 1.1 cd/lm
 LEDs/each optic 1
 Light colour White
 Required components:
 F17435_HEKLA-G2-C

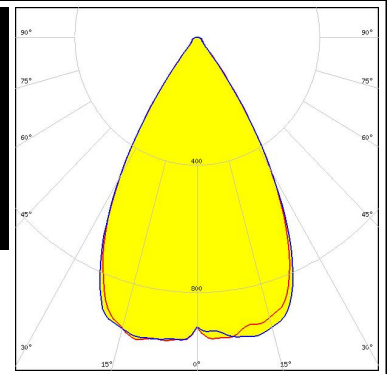
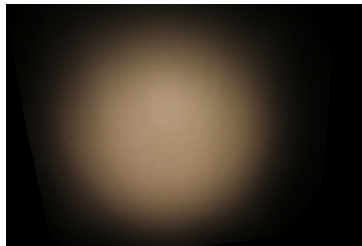

CITIZEN

LED CLU700/701/702/703
 Ordering code CP18726_YASMEEN-50-WW-C2
 FWHM / FWTM 55.0° / 75.0°
 Efficiency 84 %
 Peak intensity 1 cd/lm
 LEDs/each optic 1
 Light colour White
 Required components:
 F17435_HEKLA-G2-C

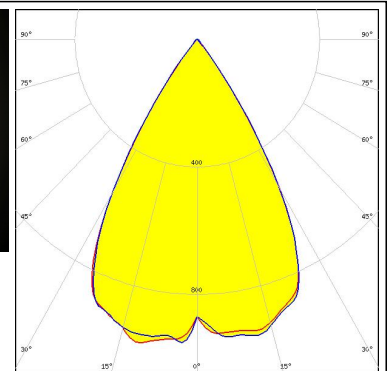
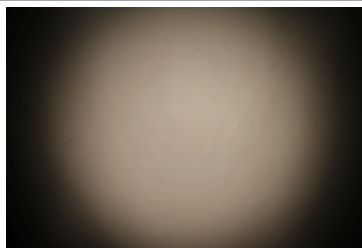

CITIZEN

LED CLU700/701/702/703
 Ordering code CP18740_YASMEEN-50-WW-C2-WHT
 FWHM / FWTM 55.0° / 77.0°
 Efficiency 92 %
 Peak intensity 1.1 cd/lm
 LEDs/each optic 1
 Light colour White
 Required components:
 F17435_HEKLA-G2-C

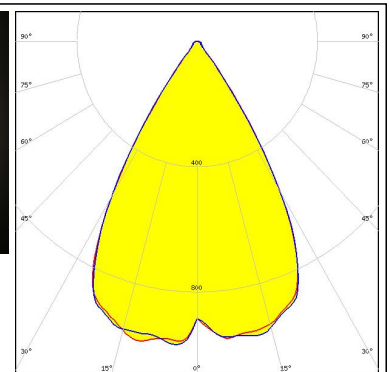
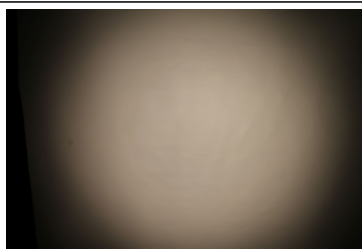

OPTICAL RESULTS (MEASURED):

CITIZEN

LED CLU7A2/7A3
Ordering code CP18726_YASMEEN-50-WW-C2
FWHM / FWTM 55.0° / 75.0°
Efficiency 84 %
Peak intensity 1.1 cd/lm
LEDs/each optic 1
Light colour White
Required components:
F17435_HEKLA-G2-C

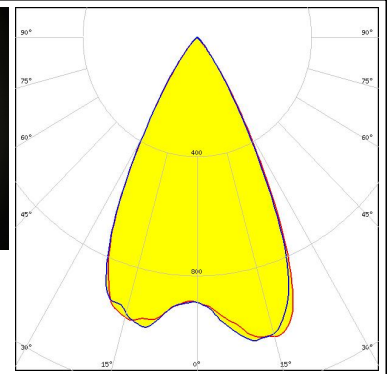
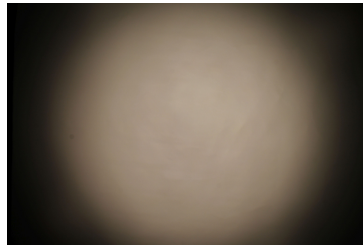

CITIZEN

LED CLU7A2/7A3
Ordering code CP18740_YASMEEN-50-WW-C2-WHT
FWHM / FWTM 55.0° / 76.0°
Efficiency 92 %
Peak intensity 1.1 cd/lm
LEDs/each optic 1
Light colour White
Required components:
F17435_HEKLA-G2-C

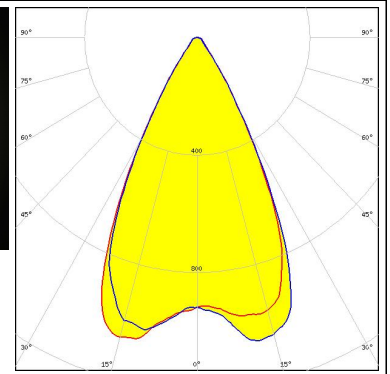

CITIZEN

LED CLU7B2
Ordering code CP18726_YASMEEN-50-WW-C2
FWHM / FWTM 54.0° / 74.0°
Efficiency 84 %
Peak intensity 1.1 cd/lm
LEDs/each optic 1
Light colour White
Required components:
F17435_HEKLA-G2-C

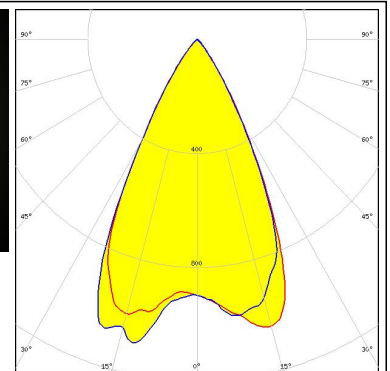
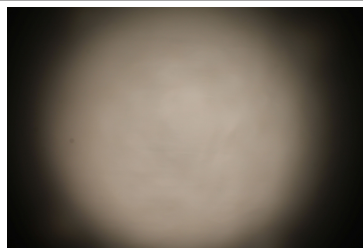

CITIZEN

LED CLU7B2
Ordering code CP18740_YASMEEN-50-WW-C2-WHT
FWHM / FWTM 55.0° / 76.0°
Efficiency 92 %
Peak intensity 1.1 cd/lm
LEDs/each optic 1
Light colour White
Required components:
F17435_HEKLA-G2-C

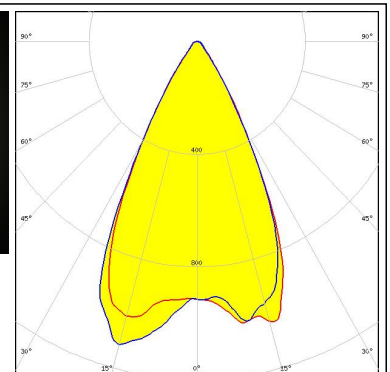
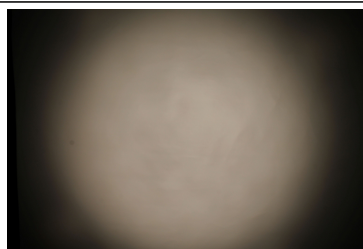

OPTICAL RESULTS (MEASURED):



LED CMA1516
Ordering code CP18726_YASMEEN-50-WW-C2
FWHM / FWTM 54.0° / 76.0°
Efficiency 83 %
Peak intensity 1 cd/lm
LEDs/each optic 1
Light colour White
Required components:
 F17436_HEKLA-G2-D

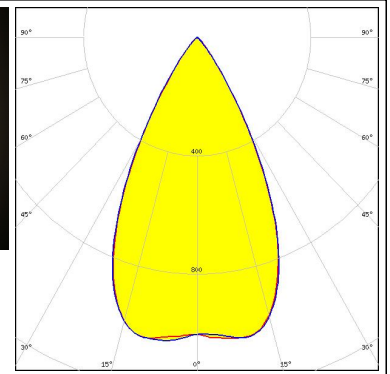
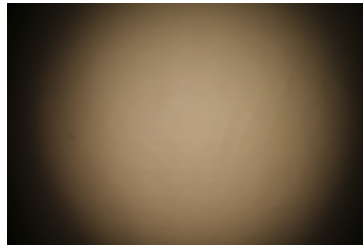

LED CMA1516
Ordering code CP18740_YASMEEN-50-WW-C2-WHT
FWHM / FWTM 54.0° / 78.0°
Efficiency 91 %
Peak intensity 1.1 cd/lm
LEDs/each optic 1
Light colour White
Required components:
 F17436_HEKLA-G2-D

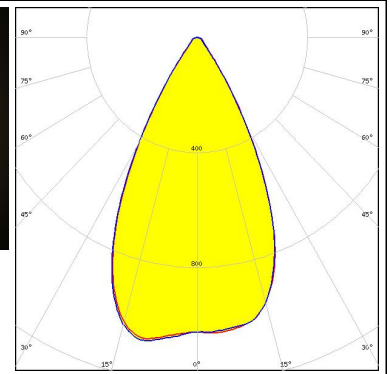

LED CMT14xx
Ordering code CP18740_YASMEEN-50-WW-C2-WHT
FWHM / FWTM 54.0° / 78.0°
Efficiency 91 %
Peak intensity 1.1 cd/lm
LEDs/each optic 1
Light colour White
Required components:
 F17435_HEKLA-G2-C

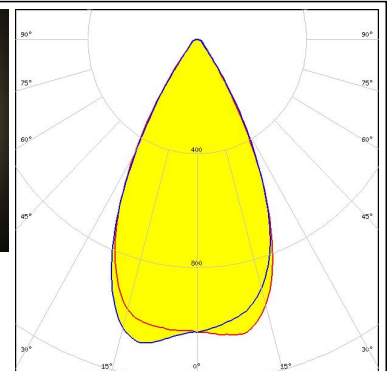
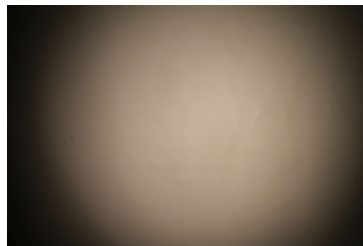

LED CMT14xx
Ordering code CP18726_YASMEEN-50-WW-C2
FWHM / FWTM 54.0° / 76.0°
Efficiency 83 %
Peak intensity 1.1 cd/lm
LEDs/each optic 1
Light colour White
Required components:
 F17435_HEKLA-G2-C

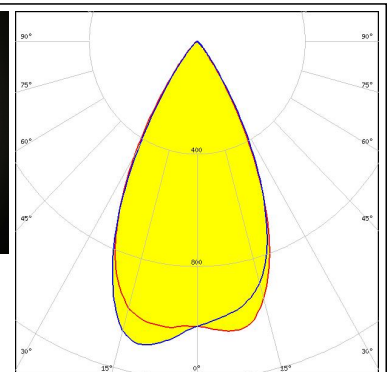
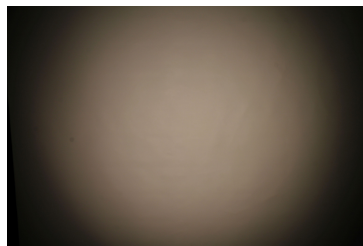

OPTICAL RESULTS (MEASURED):



LED CMU10xx
 Ordering code CP18726_YASMEEN-50-WW-C2
 FWHM / FWTM 48.0° / 72.0°
 Efficiency 81 %
 Peak intensity 1.3 cd/lm
 LEDs/each optic 1
 Light colour White
 Required components:
 F17435_HEKLA-G2-C

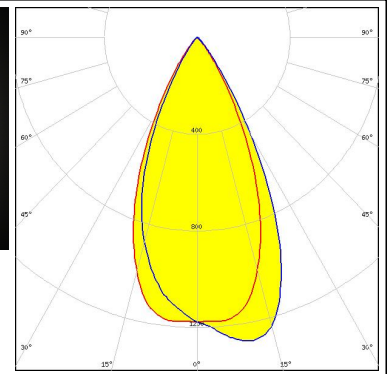
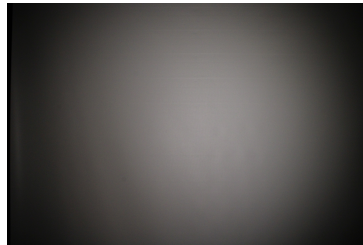

LED CXA/B 13xx
 Ordering code CP18726_YASMEEN-50-WW-C2
 FWHM / FWTM 55.0° / 74.0°
 Efficiency 84 %
 Peak intensity 1.1 cd/lm
 LEDs/each optic 1
 Light colour White
 Required components:
 F17439_HEKLA-G2-J

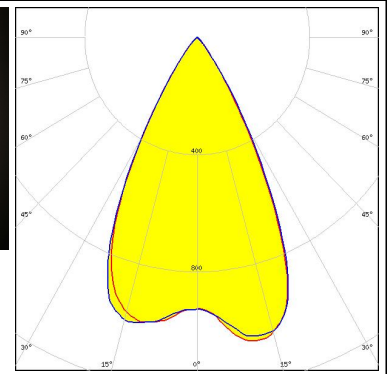
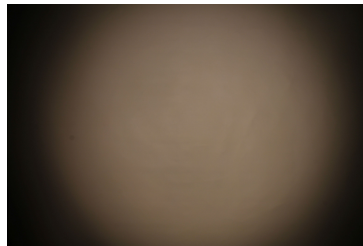

LED CXA/B 13xx
 Ordering code CP18740_YASMEEN-50-WW-C2-WHT
 FWHM / FWTM 55.0° / 77.0°
 Efficiency 92 %
 Peak intensity 1.1 cd/lm
 LEDs/each optic 1
 Light colour White
 Required components:
 F17439_HEKLA-G2-J

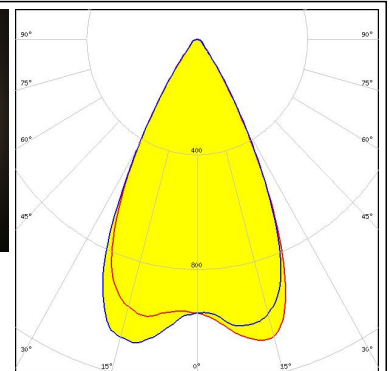
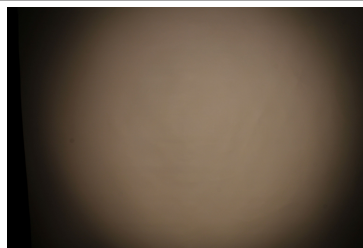

LED CXA/B 15xx
 Ordering code CP18726_YASMEEN-50-WW-C2
 FWHM / FWTM 54.0° / 75.0°
 Efficiency 84 %
 Peak intensity 1.1 cd/lm
 LEDs/each optic 1
 Light colour White
 Required components:
 F17436_HEKLA-G2-D

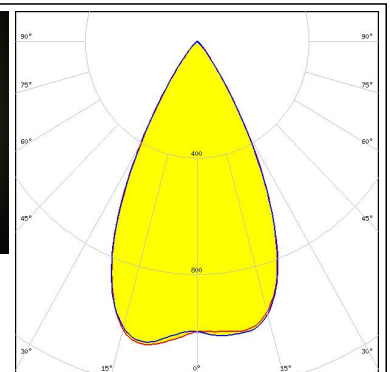
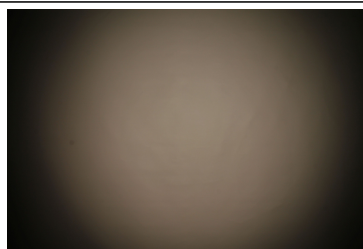

OPTICAL RESULTS (MEASURED):



LED CXA/B 15xx
Ordering code CP18740_YASMEEN-50-WW-C2-WHT
FWHM / FWTM 55.0° / 78.0°
Efficiency 92 %
Peak intensity 1.1 cd/lm
LEDs/each optic 1
Light colour White
Required components:
 F17436_HEKLA-G2-D

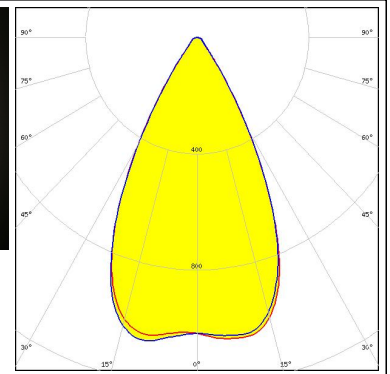
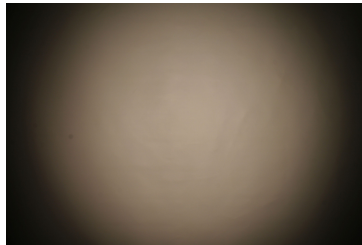

LED LEDIM/C6
Ordering code CP18726_YASMEEN-50-WW-C2
FWHM / FWTM 57.0° / 78.0°
Efficiency 83 %
Peak intensity 1 cd/lm
LEDs/each optic 1
Light colour White
Required components:
 F17438_HEKLA-G2-I

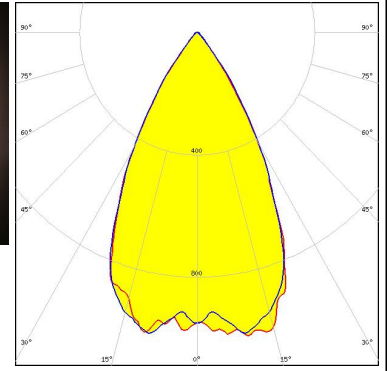

LED LUXEON CoB 1202/1203
Ordering code CP18726_YASMEEN-50-WW-C2
FWHM / FWTM 54.0° / 75.0°
Efficiency 83 %
Peak intensity 1.1 cd/lm
LEDs/each optic 1
Light colour White
Required components:
 F17437_HEKLA-G2-H

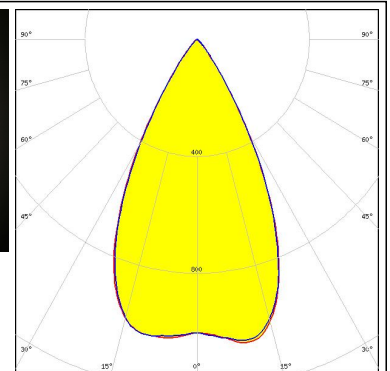
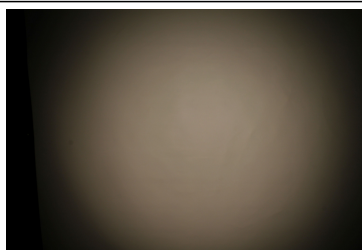

LED LUXEON CoB 1202/1203
Ordering code CP18740_YASMEEN-50-WW-C2-WHT
FWHM / FWTM 54.0° / 77.0°
Efficiency 91 %
Peak intensity 1.1 cd/lm
LEDs/each optic 1
Light colour White
Required components:
 F17437_HEKLA-G2-H

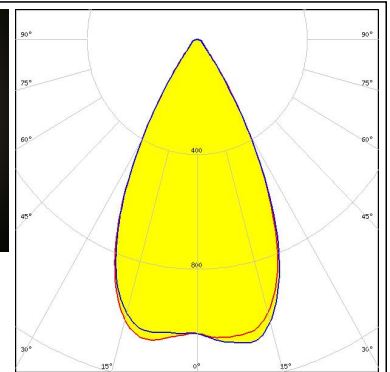
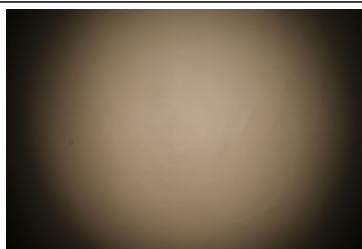

OPTICAL RESULTS (MEASURED):

LUMILEDS

LED LUXEON CoB 1204HD
 Ordering code CP18726_YASMEEN-50-WW-C2
 FWHM / FWTM 53.0° / 75.0°
 Efficiency 83 %
 Peak intensity 1.1 cd/lm
 LEDs/each optic 1
 Light colour White
 Required components:
 F17437_HEKLA-G2-H

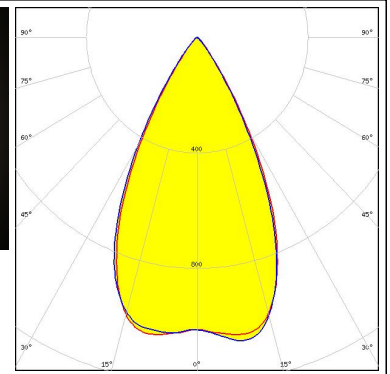
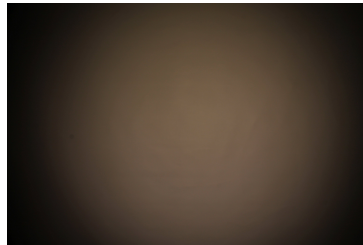

LUMILEDS

LED LUXEON CoB 1204HD
 Ordering code CP18740_YASMEEN-50-WW-C2-WHT
 FWHM / FWTM 54.0° / 77.0°
 Efficiency 92 %
 Peak intensity 1.1 cd/lm
 LEDs/each optic 1
 Light colour White
 Required components:
 F17437_HEKLA-G2-H

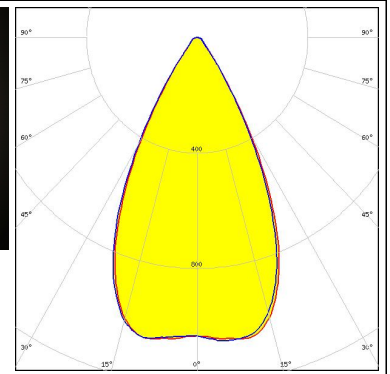
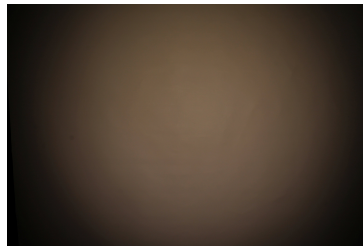

LUMILEDS

LED LUXEON CoB M02/M03
 Ordering code CP18726_YASMEEN-50-WW-C2
 FWHM / FWTM 54.0° / 75.0°
 Efficiency 84 %
 Peak intensity 1.1 cd/lm
 LEDs/each optic 1
 Light colour White
 Required components:
 F17436_HEKLA-G2-D

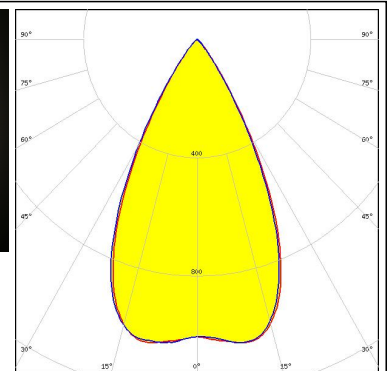
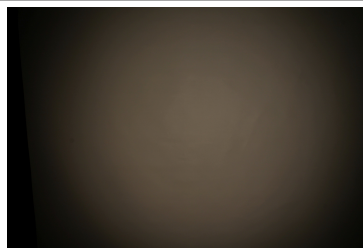

LUMILEDS

LED LUXEON CoB M02/M03
 Ordering code CP18740_YASMEEN-50-WW-C2-WHT
 FWHM / FWTM 54.0° / 77.0°
 Efficiency 92 %
 Peak intensity 1.1 cd/lm
 LEDs/each optic 1
 Light colour White
 Required components:
 F17436_HEKLA-G2-D

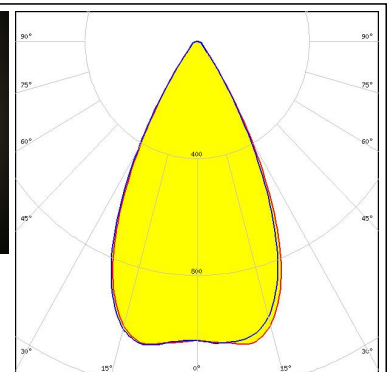
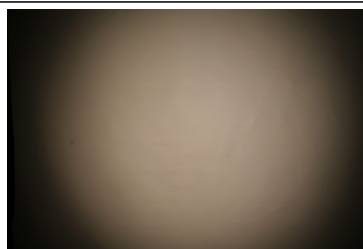

OPTICAL RESULTS (MEASURED):

LUMILEDS

LED LUXEON CoB S01
 Ordering code CP18726_YASMEEN-50-WW-C2
 FWHM / FWTM 55.0° / 75.0°
 Efficiency 84 %
 Peak intensity 1.1 cd/lm
 LEDs/each optic 1
 Light colour White
 Required components:
 F17439_HEKLA-G2-J

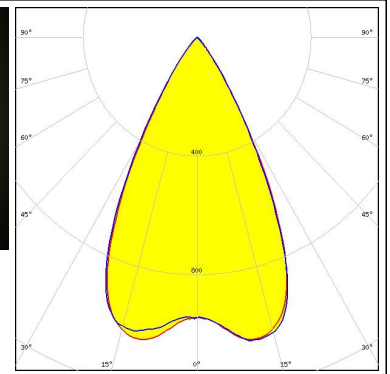

LUMILEDS

LED LUXEON CoB S01
 Ordering code CP18740_YASMEEN-50-WW-C2-WHT
 FWHM / FWTM 55.0° / 77.0°
 Efficiency 92 %
 Peak intensity 1.1 cd/lm
 LEDs/each optic 1
 Light colour White
 Required components:
 F17439_HEKLA-G2-J

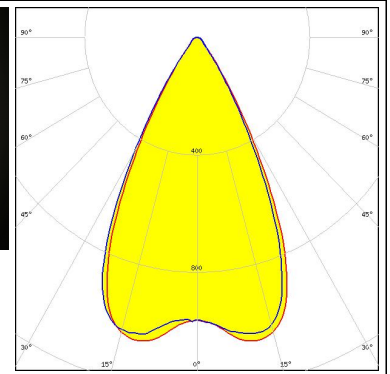
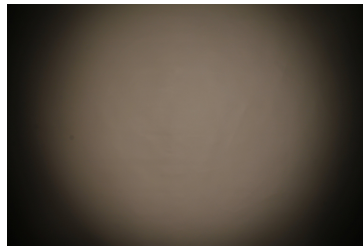

LUMINUS

LED CTM-14 (Tunable White) Gen2
 Ordering code CP18726_YASMEEN-50-WW-C2
 FWHM / FWTM 50.0° / 76.0°
 Efficiency 79 %
 Peak intensity 1.1 cd/lm
 LEDs/each optic 1
 Light colour Tunable White
 Required components:
 C16142_HEKLA-SOCKET-K
 Bender Wirth: 442 Typ L8

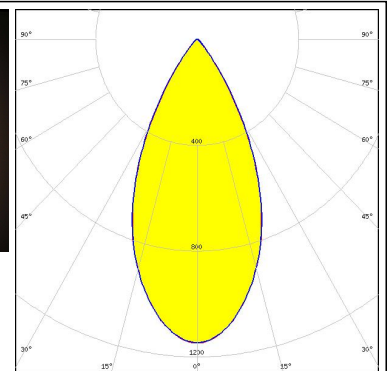
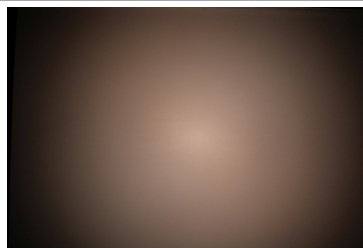

LUMINUS

LED CXM-3
 Ordering code CP18726_YASMEEN-50-WW-C2
 FWHM / FWTM 55.0° / 75.0°
 Efficiency 84 %
 Peak intensity 1.1 cd/lm
 LEDs/each optic 1
 Light colour White
 Required components:
 F17435_HEKLA-G2-C

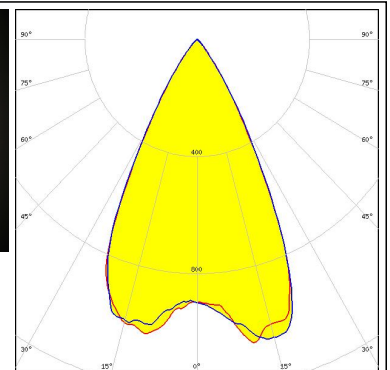
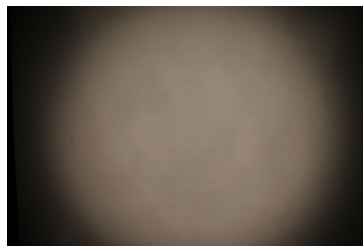

OPTICAL RESULTS (MEASURED):



LED CXM-3
Ordering code CP18740_YASMEEN-50-WW-C2-WHT
FWHM / FWTM 55.0° / 76.0°
Efficiency 92 %
Peak intensity 1.1 cd/lm
LEDs/each optic 1
Light colour White
Required components:
 F17435_HEKLA-G2-C

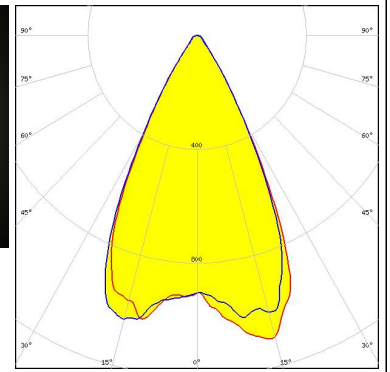

LED CXM-4
Ordering code CP18740_YASMEEN-50-WW-C2-WHT
FWHM / FWTM 55.0° / 77.0°
Efficiency 92 %
Peak intensity 1.1 cd/lm
LEDs/each optic 1
Light colour White
Required components:
 F17435_HEKLA-G2-C

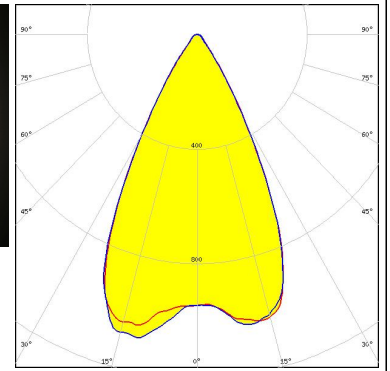
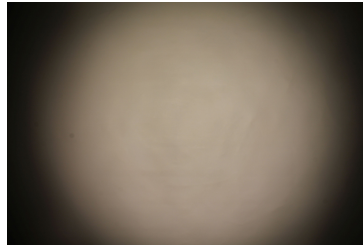

LED CXM-4
Ordering code CP18726_YASMEEN-50-WW-C2
FWHM / FWTM 55.0° / 75.0°
Efficiency 84 %
Peak intensity 1.1 cd/lm
LEDs/each optic 1
Light colour White
Required components:
 F17435_HEKLA-G2-C

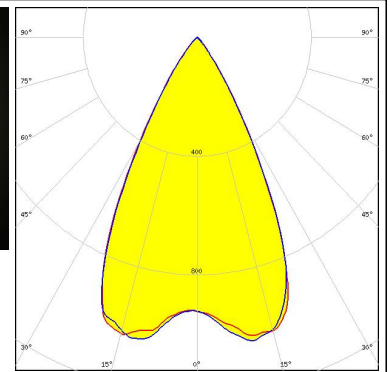
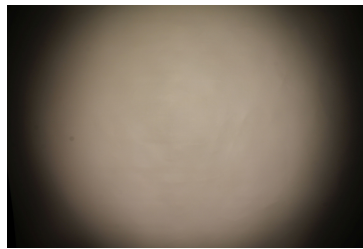

LED COB L-Type (LES 9)
Ordering code CP18740_YASMEEN-50-WW-C2-WHT
FWHM / FWTM 55.0° / 78.0°
Efficiency 91 %
Peak intensity 1.1 cd/lm
LEDs/each optic 1
Light colour White
Required components:
 F17437_HEKLA-G2-H

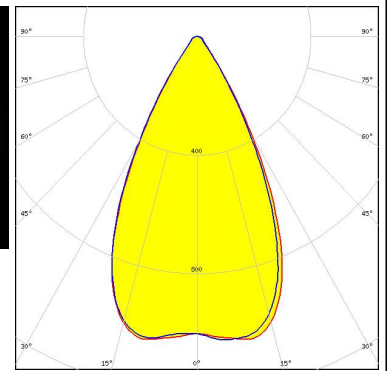
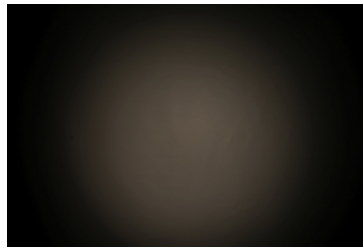

OPTICAL RESULTS (MEASURED):



LED COB S-Type (LES 7)
Ordering code CP18740_YASMEEN-50-WW-C2-WHT
FWHM / FWTM 55.0° / 77.0°
Efficiency 90 %
Peak intensity 1 cd/lm
LEDs/each optic 1
Light colour White
Required components:
 F15848_HEKLA-SOCKET-G

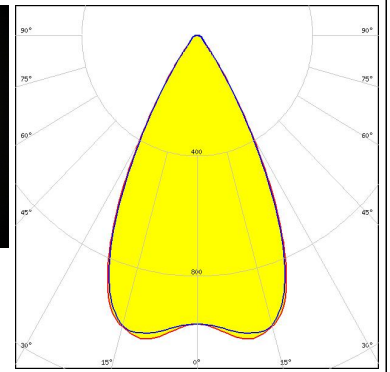

LED Fortimo SLM L09 CoB
Ordering code CP18726_YASMEEN-50-WW-C2
FWHM / FWTM 54.0° / 75.0°
Efficiency 83 %
Peak intensity 1.1 cd/lm
LEDs/each optic 1
Light colour White
Required components:
 F17437_HEKLA-G2-H

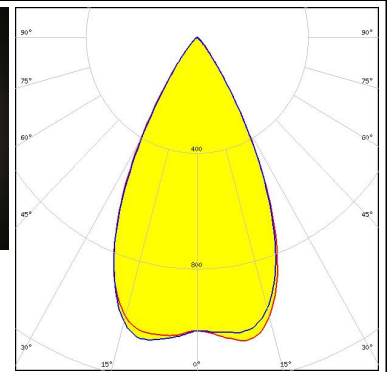

LED Fortimo SLM L09 CoB
Ordering code CP18740_YASMEEN-50-WW-C2-WHT
FWHM / FWTM 54.0° / 77.0°
Efficiency 92 %
Peak intensity 1.1 cd/lm
LEDs/each optic 1
Light colour White
Required components:
 F17437_HEKLA-G2-H

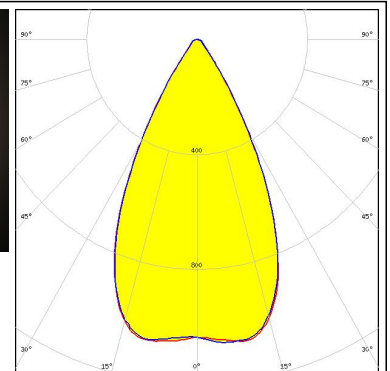
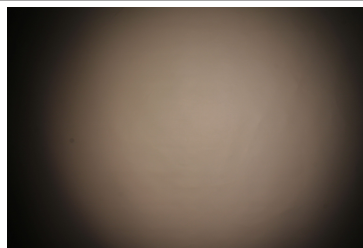

LED LC003D / LC006D / LC009D / LC013D
Ordering code CP18726_YASMEEN-50-WW-C2
FWHM / FWTM 54.0° / 76.0°
Efficiency 83 %
Peak intensity 1.1 cd/lm
LEDs/each optic 1
Light colour White
Required components:
 F17435_HEKLA-G2-C

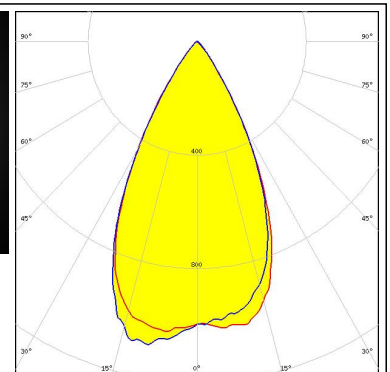
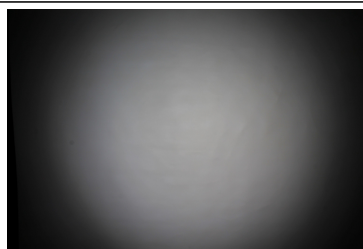

OPTICAL RESULTS (MEASURED):

SAMSUNG

LED LC003D / LC006D / LC009D / LC013D
 Ordering code CP18740_YASMEEN-50-WW-C2-WHT
 FWHM / FWTM 54.0° / 78.0°
 Efficiency 91 %
 Peak intensity 1.1 cd/lm
 LEDs/each optic 1
 Light colour White
 Required components:
 F17435_HEKLA-G2-C

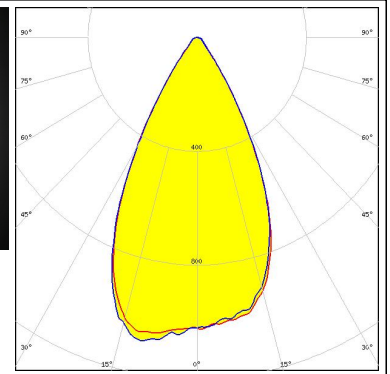
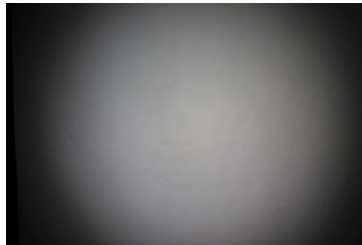

SEOUL SEMICONDUCTOR
 LED MJT COB LES 6
 Ordering code CP18740_YASMEEN-50-WW-C2-WHT
 FWHM / FWTM 55.0° / 77.0°
 Efficiency 93 %
 Peak intensity 1.1 cd/lm
 LEDs/each optic 1
 Light colour White
 Required components:
 F17435_HEKLA-G2-C

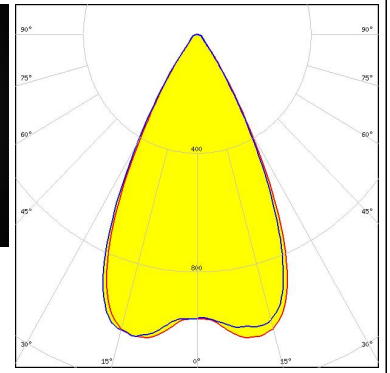
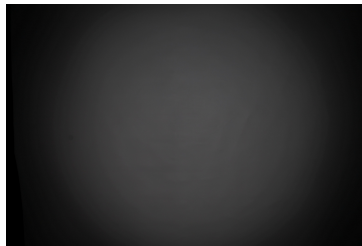

SEOUL SEMICONDUCTOR
 LED MJT COB LES 6
 Ordering code CP18726_YASMEEN-50-WW-C2
 FWHM / FWTM 55.0° / 75.0°
 Efficiency 84 %
 Peak intensity 1.1 cd/lm
 LEDs/each optic 1
 Light colour White
 Required components:
 F17435_HEKLA-G2-C

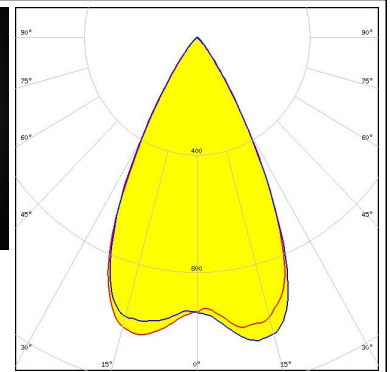
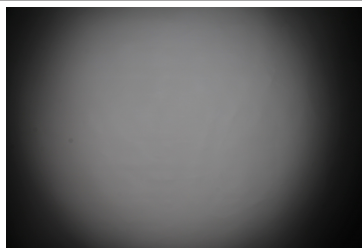

SEOUL SEMICONDUCTOR
 LED MJT COB LES 9.8
 Ordering code CP18726_YASMEEN-50-WW-C2
 FWHM / FWTM 54.0° / 76.0°
 Efficiency 83 %
 Peak intensity 1 cd/lm
 LEDs/each optic 1
 Light colour White
 Required components:
 F17435_HEKLA-G2-C

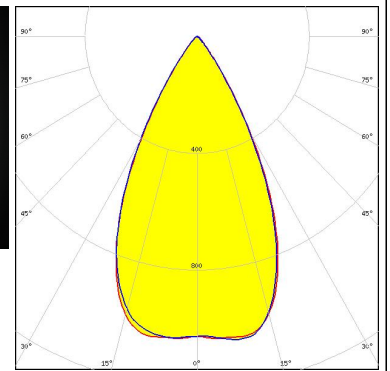
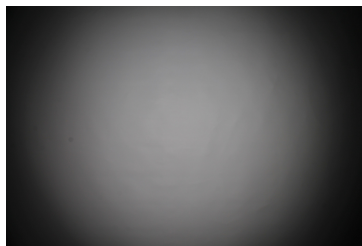

OPTICAL RESULTS (MEASURED):



OPTICAL RESULTS (SIMULATED):

bridgelux

LED V3 HD Gen 8
Ordering code CP18726_YASMEEN-50-WW-C2
FWHM / FWTM 62.0° / 76.0°
Efficiency 89 %
Peak intensity 1 cd/lm
LEDs/each optic 1
Light colour White
Required components:
F15253_HEKLA-SOCKET-A

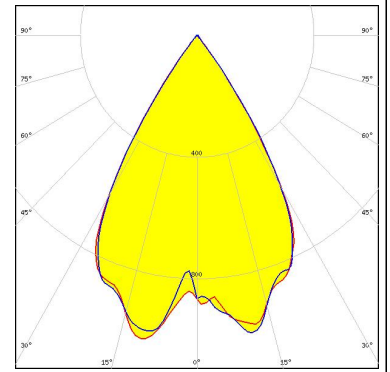

bridgelux

LED V3 HD Gen 8 FC
Ordering code CP18726_YASMEEN-50-WW-C2
FWHM / FWTM 64.0° / 77.0°
Efficiency 88 %
Peak intensity 1 cd/lm
LEDs/each optic 1
Light colour White
Required components:
F15255_HEKLA-SOCKET-C

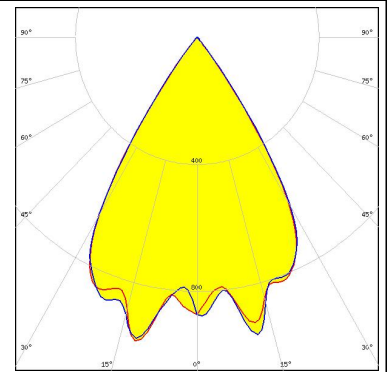

bridgelux

LED V4 HD Gen 8
Ordering code CP18726_YASMEEN-50-WW-C2
FWHM / FWTM 62.0° / 76.0°
Efficiency 89 %
Peak intensity 1 cd/lm
LEDs/each optic 1
Light colour White
Required components:
F15253_HEKLA-SOCKET-A



bridgelux

LED V6 Gen 8-9
Ordering code CP18726_YASMEEN-50-WW-C2
FWHM / FWTM 62.0° / 78.0°
Efficiency 87 %
Peak intensity 1 cd/lm
LEDs/each optic 1
Light colour White
Required components:
F15253_HEKLA-SOCKET-A

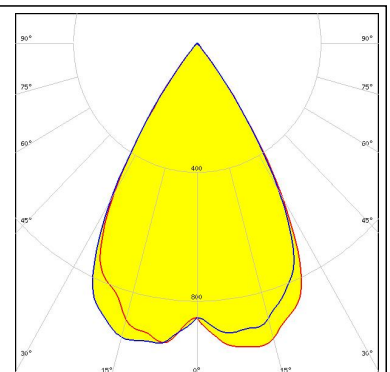

OPTICAL RESULTS (SIMULATED):



LED V6 HD Gen 8
Ordering code CP18726_YASMEEN-50-WW-C2
FWHM / FWTM 62.0° / 78.0°
Efficiency 87 %
Peak intensity 1 cd/lm
LEDs/each optic 1
Light colour White
Required components:
F15255_HEKLA-SOCKET-C

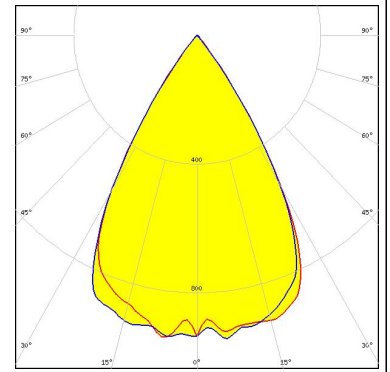

LED V9 HD Gen 8
Ordering code CP18726_YASMEEN-50-WW-C2
FWHM / FWTM 62.0° / 79.0°
Efficiency 85 %
Peak intensity 0.9 cd/lm
LEDs/each optic 1
Light colour White
Required components:
F15859_HEKLA-SOCKET-I

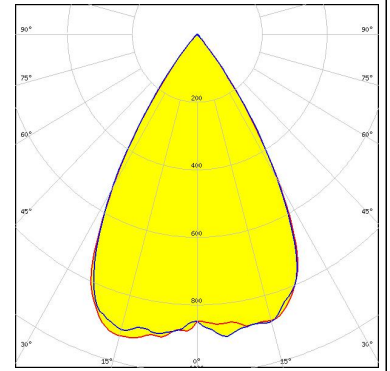

LED Vero SE 13
Ordering code CP18726_YASMEEN-50-WW-C2
FWHM / FWTM 44.0° / 69.0°
Efficiency 77 %
Peak intensity 1.4 cd/lm
LEDs/each optic 1
Light colour White
Required components:
C16142_HEKLA-SOCKET-K

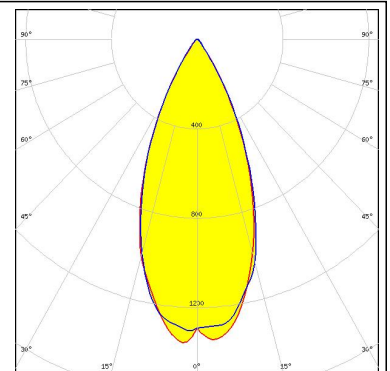

LED VERO13
Ordering code CP18726_YASMEEN-50-WW-C2
FWHM / FWTM 60.0° / 82.0°
Efficiency 80 %
Peak intensity 0.9 cd/lm
LEDs/each optic 1
Light colour White
Required components:
C16142_HEKLA-SOCKET-K

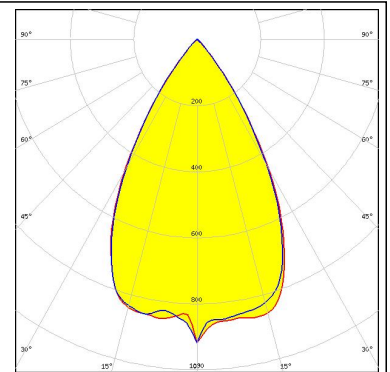

OPTICAL RESULTS (SIMULATED):



LED Vesta DTW 6mm
Ordering code CP18726_YASMEEN-50-WW-C2
FWHM / FWTM 62.0° / 78.0°
Efficiency 87 %
Peak intensity 1 cd/lm
LEDs/each optic 1
Light colour White
Required components:
 Bender Wirth: 652b Hekla

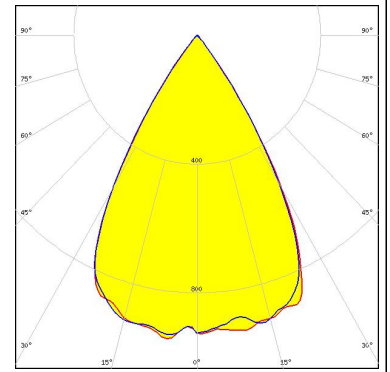

LED Vesta SE 13mm TW
Ordering code CP18726_YASMEEN-50-WW-C2
FWHM / FWTM 49.0° / 74.0°
Efficiency 77 %
Peak intensity 1.2 cd/lm
LEDs/each optic 1
Light colour Tunable White
Required components:
 C16142_HEKLA-SOCKET-K

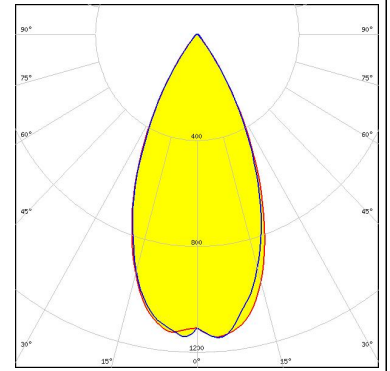

LED Vesta TW 13mm (18W) DP
Ordering code CP18726_YASMEEN-50-WW-C2
FWHM / FWTM 53.0° / 76.0°
Efficiency 81 %
Peak intensity 1.1 cd/lm
LEDs/each optic 1
Light colour Tunable White
Required components:
 C16142_HEKLA-SOCKET-K
 Bender Wirth: 492 Typ L8

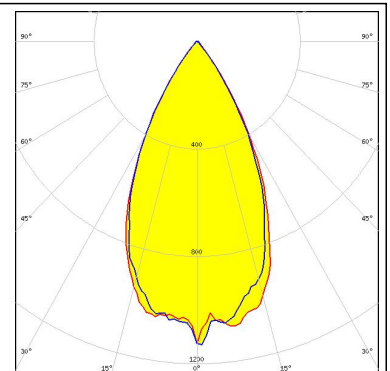

LED Vesta TW 15mm DP
Ordering code CP18726_YASMEEN-50-WW-C2
FWHM / FWTM 50.0° / 78.0°
Efficiency 78 %
Peak intensity 1.1 cd/lm
LEDs/each optic 1
Light colour Tunable White
Required components:
 C16142_HEKLA-SOCKET-K
 Bender Wirth: 482 Typ L8

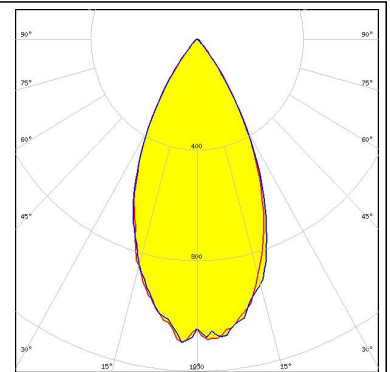

OPTICAL RESULTS (SIMULATED):



LED Vesta TW 9mm (9W) DP
Ordering code CP18726_YASMEEN-50-WW-C2
FWHM / FWTM 64.0° / 83.0°
Efficiency 78 %
Peak intensity 0.8 cd/lm
LEDs/each optic 1
Light colour Tunable White
Required components:
C16142_HEKLA-SOCKET-K
Bender Wirth: 489 Typ L8

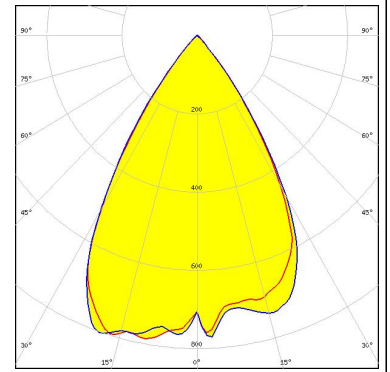

CITIZEN

LED CLL02x/CLU02x (LES10)
Ordering code CP18733_YASMEEN-50-WW-B2
FWHM / FWTM 60.0° / 78.0°
Efficiency 85 %
Peak intensity 1 cd/lm
LEDs/each optic 1
Light colour White
Required components:
BJB: 47.360.1020

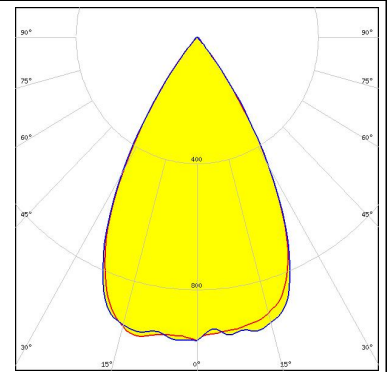

CITIZEN

LED CLL02x/CLU02x (LES10)
Ordering code CP18747_YASMEEN-50-WW-B2-WHT
FWHM / FWTM 60.0° / 80.0°
Efficiency 92 %
Peak intensity 1 cd/lm
LEDs/each optic 1
Light colour White
Required components:
BJB: 47.360.1020

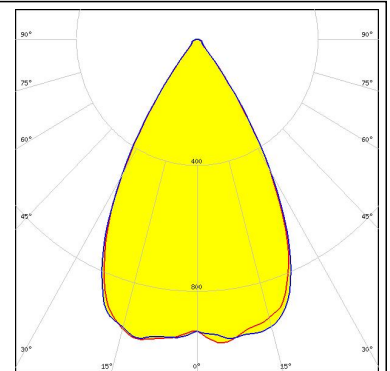

CITIZEN

LED CLU712/713
Ordering code CP18726_YASMEEN-50-WW-C2
FWHM / FWTM 60.0° / 78.0°
Efficiency 86 %
Peak intensity 1 cd/lm
LEDs/each optic 1
Light colour White
Required components:
F17438_HEKLA-G2-I

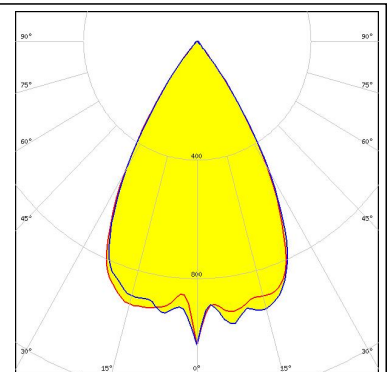

OPTICAL RESULTS (SIMULATED):

LUMILEDS

LED LUXEON CX Plus CoB L08 (Gen2)
 Ordering code CP18726_YASMEEN-50-WW-C2
 FWHM / FWTM 52.0° / 79.0°
 Efficiency 79 %
 Peak intensity 1.1 cd/lm
 LEDs/each optic 1
 Light colour White
 Required components:
 Bender Wirth: 637a Hekla

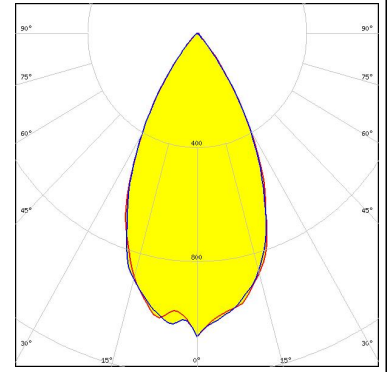

LUMILEDS

LED LUXEON 7070
 FWHM / FWTM 60.0° / 76.0°
 Efficiency 96 %
 Peak intensity 1 cd/lm
 LEDs/each optic 1
 Light colour White
 Required components:

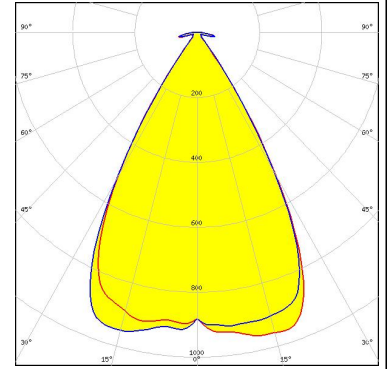

LUMILEDS

LED LUXEON CoB 1202/1203
 Ordering code CP18726_YASMEEN-50-WW-C2
 FWHM / FWTM 60.0° / 78.0°
 Efficiency 86 %
 Peak intensity 1 cd/lm
 LEDs/each optic 1
 Light colour White
 Required components:
 F15858_HEKLA-SOCKET-H

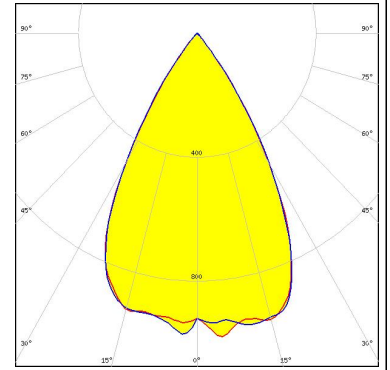

LUMILEDS

LED LUXEON CoB 1202HD
 Ordering code CP18726_YASMEEN-50-WW-C2
 FWHM / FWTM 62.0° / 78.0°
 Efficiency 88 %
 Peak intensity 1 cd/lm
 LEDs/each optic 1
 Light colour White
 Required components:
 F15848_HEKLA-SOCKET-G

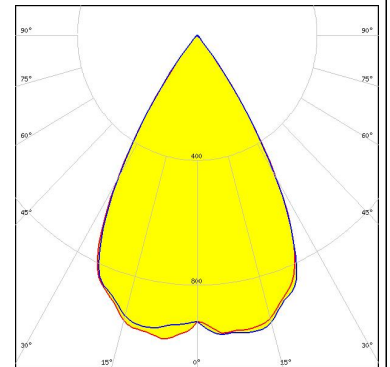

OPTICAL RESULTS (SIMULATED):

LUMILEDS

LED LUXEON CoB 1204/1205
 Ordering code CP18726_YASMEEN-50-WW-C2
 FWHM / FWTM 56.0° / 79.0°
 Efficiency 81 %
 Peak intensity 1 cd/lm
 LEDs/each optic 1
 Light colour White
 Required components:
 Bender Wirth: 632a Hekla XL

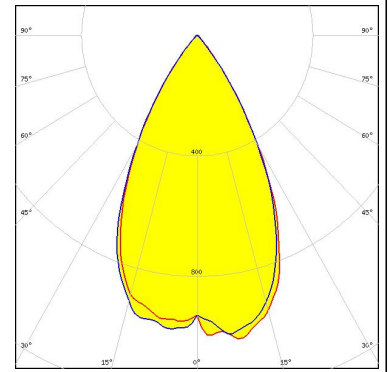

LUMILEDS

LED LUXEON CoB 1205HD
 Ordering code CP18726_YASMEEN-50-WW-C2
 FWHM / FWTM 58.0° / 79.0°
 Efficiency 84 %
 Peak intensity 1 cd/lm
 LEDs/each optic 1
 Light colour White
 Required components:
 F15858_HEKLA-SOCKET-H

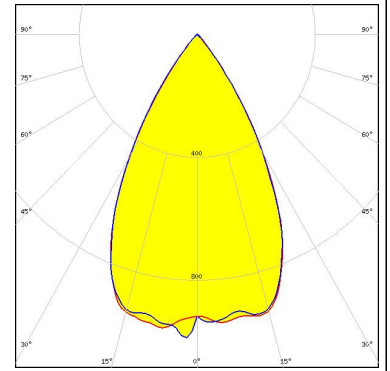

LUMILEDS

LED LUXEON CoB 1208
 Ordering code CP18726_YASMEEN-50-WW-C2
 FWHM / FWTM 52.0° / 78.0°
 Efficiency 80 %
 Peak intensity 1.1 cd/lm
 LEDs/each optic 1
 Light colour White
 Required components:
 Bender Wirth: 632a Hekla XL

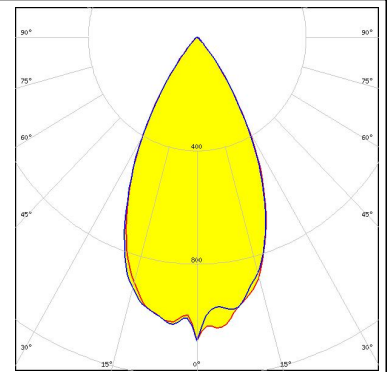

LUMILEDS

LED LUXEON CX Plus CoB - HD S01H4
 Ordering code CP18733_YASMEEN-50-WW-B2
 FWHM / FWTM 64.0° / 78.0°
 Efficiency 86 %
 Peak intensity 0.9 cd/lm
 LEDs/each optic 1
 Light colour White
 Required components:
 Bender Wirth: 634c Bayonet35L

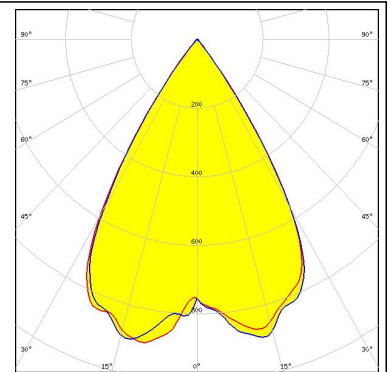

OPTICAL RESULTS (SIMULATED):

LUMILEDS

LED LUXEON CX Plus CoB - HD S02H6
 Ordering code CP18733_YASMEEN-50-WW-B2
 FWHM / FWTM 63.0° / 78.0°
 Efficiency 84 %
 Peak intensity 0.9 cd/lm
 LEDs/each optic 1
 Light colour White
 Required components:
 Bender Wirth: 634c Bayonet35L

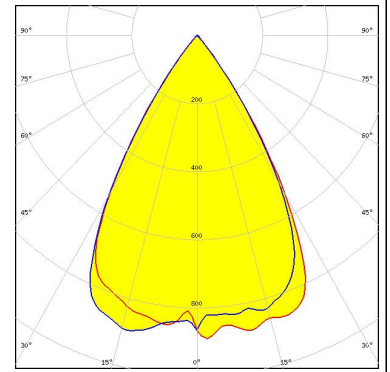

LUMILEDS

LED LUXEON CX Plus CoB - HD S04H9
 Ordering code CP18733_YASMEEN-50-WW-B2
 FWHM / FWTM 62.0° / 80.0°
 Efficiency 81 %
 Peak intensity 0.9 cd/lm
 LEDs/each optic 1
 Light colour White
 Required components:
 Bender Wirth: 634a Bayonet35L

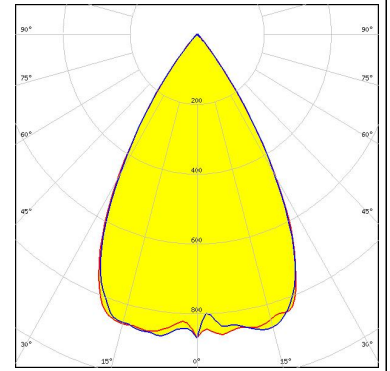

LUMILEDS

LED LUXEON CX Plus CoB L04 / L05 (Gen2)
 Ordering code CP18726_YASMEEN-50-WW-C2
 FWHM / FWTM 56.0° / 78.0°
 Efficiency 82 %
 Peak intensity 1 cd/lm
 LEDs/each optic 1
 Light colour White
 Required components:
 F15254_HEKLA-SOCKET-B

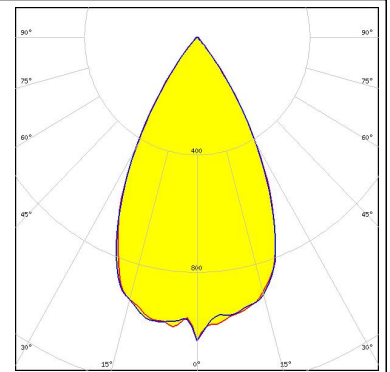

LUMILEDS

LED LUXEON CX Plus CoB M02 / M03 (Gen2)
 Ordering code CP18726_YASMEEN-50-WW-C2
 FWHM / FWTM 60.0° / 78.0°
 Efficiency 85 %
 Peak intensity 1 cd/lm
 LEDs/each optic 1
 Light colour White
 Required components:
 F15256_HEKLA-SOCKET-D

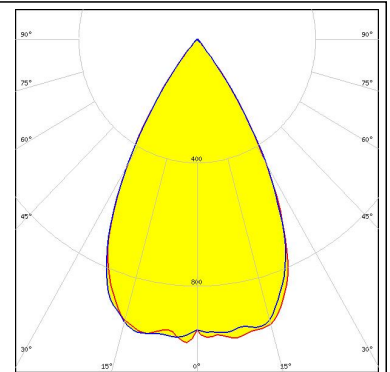

OPTICAL RESULTS (SIMULATED):



LED LUXEON CX Plus CoB S01 (Gen2)
Ordering code CP18726_YASMEEN-50-WW-C2
FWHM / FWTM 62.0° / 77.0°
Efficiency 86 %
Peak intensity 1 cd/lm
LEDs/each optic 1
Light colour White
Required components:
 F15956_HEKLA-SOCKET-J

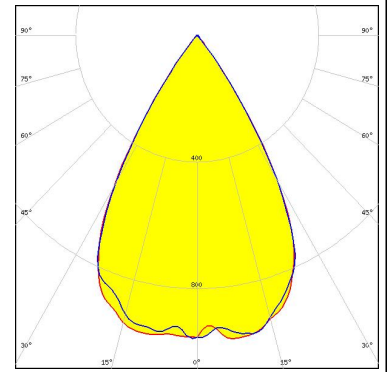

LED CHM-9 XH (19x19)
Ordering code CP18726_YASMEEN-50-WW-C2
FWHM / FWTM 60.0° / 78.0°
Efficiency 86 %
Peak intensity 1 cd/lm
LEDs/each optic 1
Light colour White
Required components:
 F15859_HEKLA-SOCKET-I

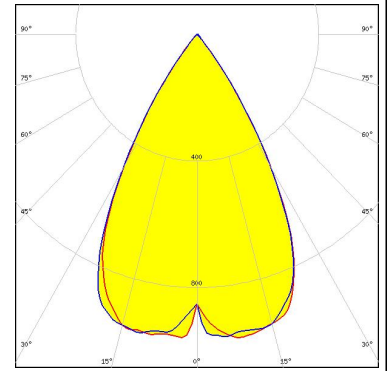

LED CTM-6 (Tunable White) Gen2
Ordering code CP18726_YASMEEN-50-WW-C2
FWHM / FWTM 62.0° / 78.0°
Efficiency 87 %
Peak intensity 1 cd/lm
LEDs/each optic 1
Light colour Tunable White
Required components:
 C16142_HEKLA-SOCKET-K
 Bender Wirth: 495 Typ L8

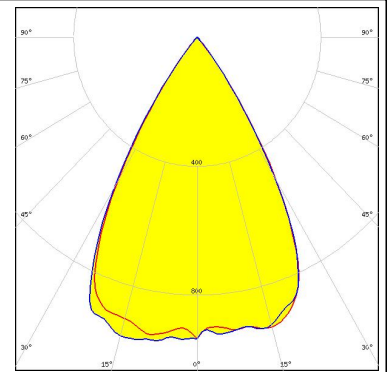

LED CTM-9 (Tunable White) Gen2
Ordering code CP18726_YASMEEN-50-WW-C2
FWHM / FWTM 59.0° / 78.0°
Efficiency 85 %
Peak intensity 1 cd/lm
LEDs/each optic 1
Light colour Tunable White
Required components:
 C16142_HEKLA-SOCKET-K
 Bender Wirth: 495 Typ L8

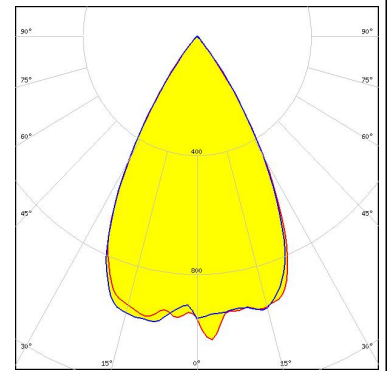

OPTICAL RESULTS (SIMULATED):



LED CxM-6 (13.5x13.5)
Ordering code CP18733_YASMEEN-50-WW-B2
FWHM / FWTM 60.0° / 76.0°
Efficiency 89 %
Peak intensity 1 cd/lm
LEDs/each optic 1
Light colour White
Required components:
BJB: 47.360.1020

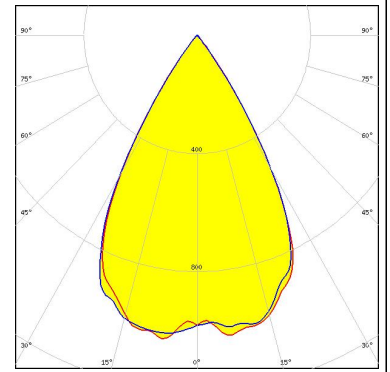

LED COB L-Type (LES 11)
Ordering code CP18726_YASMEEN-50-WW-C2
FWHM / FWTM 58.0° / 80.0°
Efficiency 83 %
Peak intensity 1 cd/lm
LEDs/each optic 1
Light colour White
Required components:
F15858_HEKLA-SOCKET-H

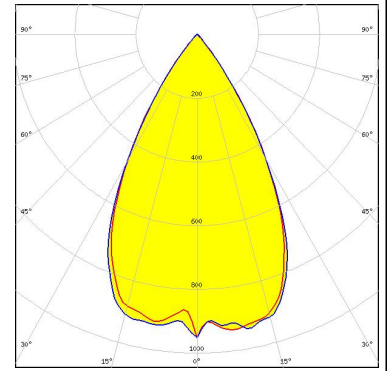

LED COB S-Type (LES 6)
Ordering code CP18733_YASMEEN-50-WW-B2
FWHM / FWTM 64.0° / 78.0°
Efficiency 85 %
Peak intensity 0.9 cd/lm
LEDs/each optic 1
Light colour White
Required components:
Bender Wirth: 652a Bayonet35L

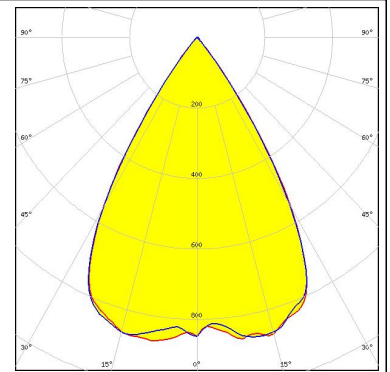

LED COB S-Type (LES 7)
Ordering code CP18733_YASMEEN-50-WW-B2
FWHM / FWTM 64.0° / 78.0°
Efficiency 84 %
Peak intensity 0.9 cd/lm
LEDs/each optic 1
Light colour White
Required components:
Bender Wirth: 652a Bayonet35L

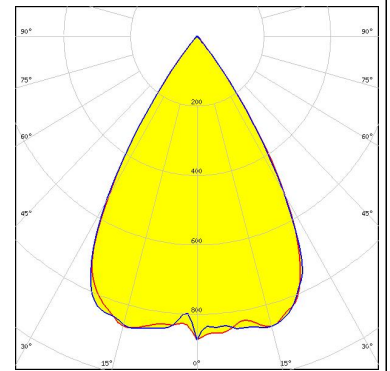

OPTICAL RESULTS (SIMULATED):



LED COB T-Type
Ordering code CP18733_YASMEEN-50-WW-B2
FWHM / FWTM 64.0° / 78.0°
Efficiency 85 %
Peak intensity 0.9 cd/lm
LEDs/each optic 1
Light colour White
Required components:
Bender Wirth: 652a Bayonet35L

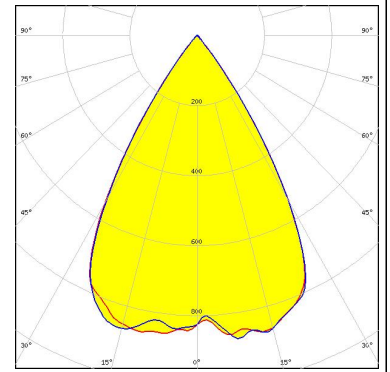

LED NJCWL024Z-V1MT: COB L-Type Tunable White
Ordering code CP18726_YASMEEN-50-WW-C2
FWHM / FWTM 60.0° / 76.0°
Efficiency 87 %
Peak intensity 1 cd/lm
LEDs/each optic 1
Light colour Tunable White
Required components:
C16142_HEKLA-SOCKET-K
Bender Wirth: 497 Typ L8 HV

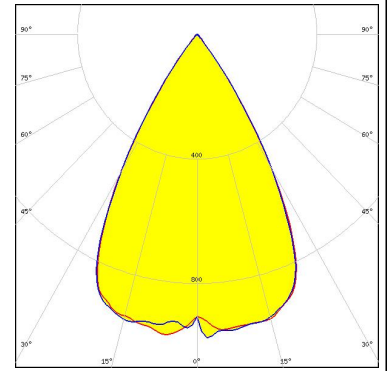

LED NJNWS012Z-V1MT: COB S-Type Tunable White
Ordering code CP18726_YASMEEN-50-WW-C2
FWHM / FWTM 62.0° / 76.0°
Efficiency 88 %
Peak intensity 1 cd/lm
LEDs/each optic 1
Light colour Tunable White
Required components:
C16142_HEKLA-SOCKET-K
Bender Wirth: 495 Typ L8 HV

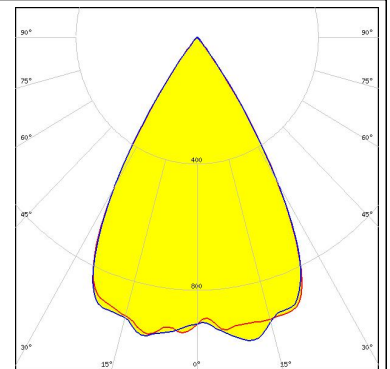

LED NVCWJ024Z-V1MT: COB J-Type Tunable White
Ordering code CP18726_YASMEEN-50-WW-C2
FWHM / FWTM 58.0° / 78.0°
Efficiency 84 %
Peak intensity 1 cd/lm
LEDs/each optic 1
Light colour Tunable White
Required components:
C16142_HEKLA-SOCKET-K
Bender Wirth: 498 Typ L8 HV

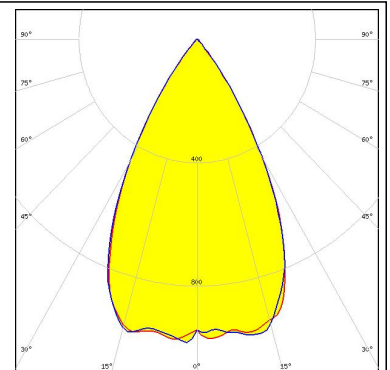

OPTICAL RESULTS (SIMULATED):



LED NVCWJ024Z-V1MT: COB J-Type Tunable White
Ordering code CP18726_YASMEEN-50-WW-C2
FWHM / FWTM 63.0° / 84.0°
Efficiency 81 %
Peak intensity 0.8 cd/lm
LEDs/each optic 1
Light colour White
Required components:
C16142_HEKLA-SOCKET-K
Bender Wirth: 498 Typ L8 HV

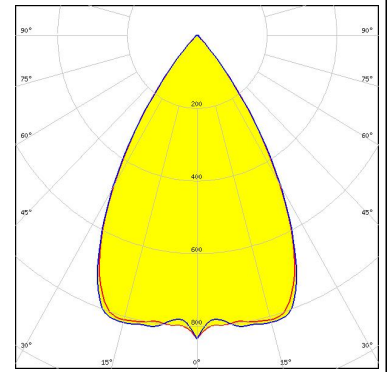

LED Soleriq S15
Ordering code CP18740_YASMEEN-50-WW-C2-WHT
FWHM / FWTM 56.0° / 84.0°
Efficiency 89 %
Peak intensity 1 cd/lm
LEDs/each optic 1
Light colour White
Required components:
F17438_HEKLA-G2-I

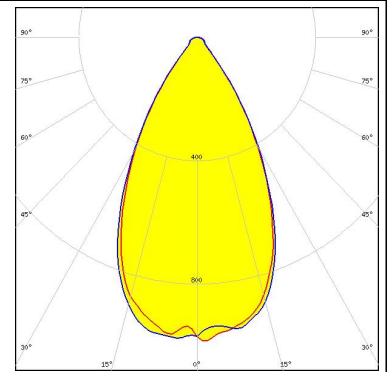

LED LC010C G2
Ordering code CP18733_YASMEEN-50-WW-B2
FWHM / FWTM 60.0° / 76.0°
Efficiency 89 %
Peak intensity 1 cd/lm
LEDs/each optic 1
Light colour White
Required components:
BJB: 47.360.1020

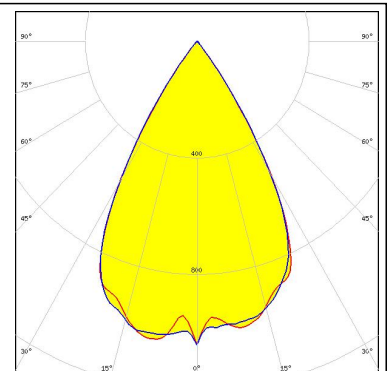

LED LC010T (Tunable White)
Ordering code CP18726_YASMEEN-50-WW-C2
FWHM / FWTM 60.0° / 78.0°
Efficiency 87 %
Peak intensity 1 cd/lm
LEDs/each optic 1
Light colour Tunable White
Required components:
C16142_HEKLA-SOCKET-K
Bender Wirth: 501 Typ L8

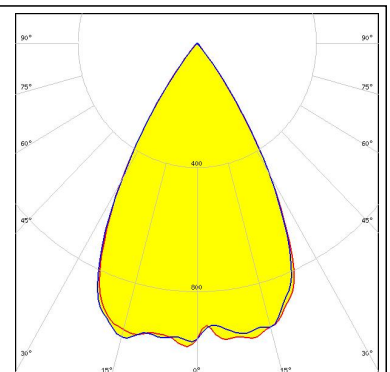

OPTICAL RESULTS (SIMULATED):

SAMSUNG

LED LC016D / LC019D / LC026D / LC033D
Ordering code CP18733_YASMEEN-50-WW-B2
FWHM / FWTM 53.0° / 80.0°
Efficiency 77 %
Peak intensity 1 cd/lm
LEDs/each optic 1
Light colour White
Required components:
BJB: 47.360.1010

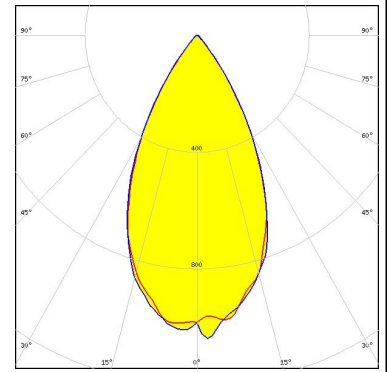

SAMSUNG

LED LC020C G2
Ordering code CP18733_YASMEEN-50-WW-B2
FWHM / FWTM 60.0° / 78.0°
Efficiency 85 %
Peak intensity 1 cd/lm
LEDs/each optic 1
Light colour White
Required components:
BJB: 47.360.1010

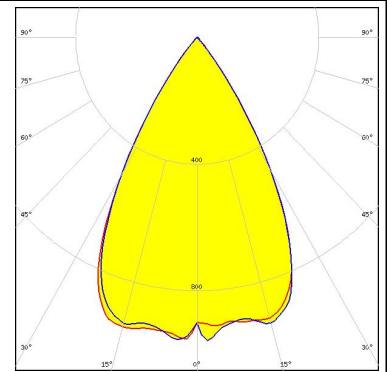

SAMSUNG

LED LC030C/040C G2
Ordering code CP18733_YASMEEN-50-WW-B2
FWHM / FWTM 58.0° / 78.0°
Efficiency 82 %
Peak intensity 1 cd/lm
LEDs/each optic 1
Light colour White
Required components:
BJB: 47.360.1010

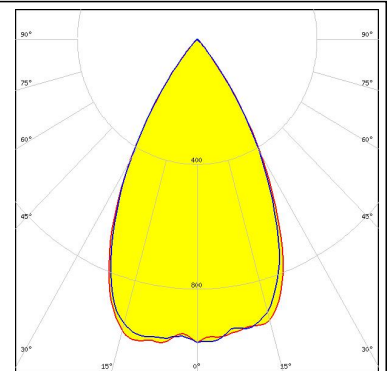

SEOUL SEMICONDUCTOR

LED MJT COB LES 14.5
Ordering code CP18726_YASMEEN-50-WW-C2
FWHM / FWTM 54.0° / 80.0°
Efficiency 80 %
Peak intensity 1.1 cd/lm
LEDs/each optic 1
Light colour White
Required components:
F15859_HEKLA-SOCKET-I

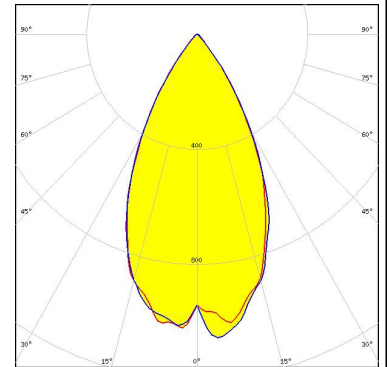

OPTICAL RESULTS (SIMULATED):

TRIDONIC

LED	SLE G7 LES13
Ordering code	CP18726_YASMEEN-50-WW-C2
FWHM / FWTM	56.0° / 80.0°
Efficiency	81 %
Peak intensity	1 cd/lm
LEDs/each optic	1
Light colour	White
Required components:	
	F17438_HEKLA-G2-I

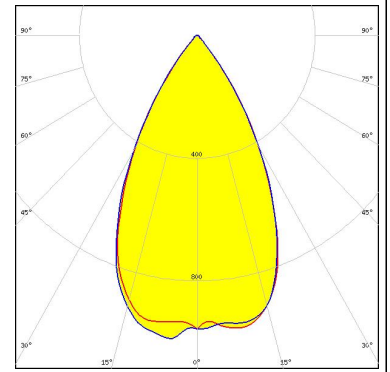

GENERAL INFORMATION:

NOTE: The typical beam angle will be changed by different color, chip size and chip position tolerance. The typical total beam angle is the full angle measured where the luminous intensity is half of the peak value.

Due to use of high power COB's with this product, special attention to proper thermal design is highly recommended. LEDiL has no liability for direct, indirect or consecutive damages arising from the LEDiL products being used outside of the recommended temperature range.

MATERIALS:

As part of our continuous research and improvement processes, and to ensure the best possible quality and availability of our products, LEDiL reserves the right to change material grades without notice.

PRODUCT DATA USER AGREEMENT AND DISCLAIMER:

The measured data in the provided downloadable LEDiL Product Datasheets and Mechanical 2D-Drawings is rounded and provided as reference for planning. LEDiL Oy's optical specifications have been verified by conducting performance testing of the products in accordance with the company's quality system. The reported data are averaged results of multiple measurements with typical variation. LEDiL Oy reserves the right to without prior notification make changes and improvements to its products.

LEDiL Oy assumes neither warranty, nor guarantee nor any other liability of any kind for the contents and correctness of the provided data. The provided data has been generated with highest diligence but the provided data may in reality not represent the complete possible variation range of all intrinsic parameters. Therefore, in certain cases a deviation from the provided data could occur.

LEDiL Oy reserves the right to undertake technical changes of its products without further notification which could lead to changes in the provided data. LEDiL Oy assumes no liability of any kind for the possible deviation from any provided data or any other damage resulting from the usage of the provided data.

The user agrees to this disclaimer and user agreement with the download or usage of the provided files.

LEDiL Oy

Joensuunkatu 13
FI-24240 SALO
Finland

LEDiL Inc.

228 West Page Street
Suite D
Sycamore IL 60178
USA

Ledil Optics Technology (Shenzhen) Co., Ltd.

405 , Block B
Casic Motor Building
Shenzhen 518057
P.R.CHINA

Local sales and technical support

[www.ledil.com/
where_to_buy](http://www.ledil.com/where_to_buy)

Shipping locations

Salo, Finland
Hong Kong, China

Distribution Partners

[www.ledil.com/
where_to_buy](http://www.ledil.com/where_to_buy)